

Greenhouse Gas Reporting Program

XML Reporting Instructions for Subpart Y - Petroleum Refineries

United States Environmental Protection Agency
Climate Change Division
Washington, DC

March 19, 2012

These instructions explain how to report the required data for the applicable regulations. Owners and operators of units should refer to the applicable regulations for information about what data are required to be reported.

EPA has finalized a rule that defers the deadline for reporting data elements used as inputs to emission equations for direct emitters. (See <http://www.epa.gov/climatechange/emissions/notices.html> for a pre-publication version of the rule). In accordance with the rule, e-GGRT is not currently collecting data used as inputs to emission equations.

[This page intentionally left blank]

Table of Contents

	<u>Page</u>
I. Introduction	1
II. Summary of Changes	9
III. Subpart Y Overview	11
1.0 Subpart Y Total Emissions	15
2.0 Flares Unit Information	18
2.1 Equation Y-1a Details, Gas Composition Monitored.....	24
2.2 Equation Y-1b Details, Gas Composition Monitored.....	28
2.3 Equation Y-2 Details, Heat Content Monitored	32
2.4 Equation Y-3 Details, Start-up, Shutdown, Malfunction.....	35
3.0 Catalytic Cracking, Fluid Coking and Catalytic Reforming Unit Information.....	37
3.1 Cracking Coking Unit Details	37
3.2 Cracking Coking CEMS Unit Details.....	57
4.0 Sulfur Recovery Details.....	58
4.1 Sour Gas Sent Off-site.....	58
4.2 Sulfur Recovery Plant Information.....	61
4.3 Sulfur Recovery CEMS Details.....	76
5.0 Coke Calcining Unit Information	77
5.1 Coke Calcining Unit Details.....	77
5.2 Coke Calcining CEMS Details	84
6.0 Asphalt Blowing Operations.....	85
6.1 Equation Y-14 and Y-15 Details	88
6.2 Equation Y-17 Details	90
6.3 Equation Y-19 Process Vent Method Details.....	93
7.0 Delayed Coking Emissions Summary	97
7.1 Subpart Level Delayed Coking Details	97
7.2 Delayed Coking Unit Details.....	99
7.3 Coking Drums Set Details	101
8.0 Process Vents Unit Information	103
9.0 Uncontrolled Blowdown Systems	111
10.0 Equipment Leaks.....	118
11.0 Storage Tanks	121
11.1 Details for Storage Tanks Used to Process Stabilized Crude.....	121
11.2 Details for Storage Tanks Used to Process Unstabilized Crude	123
12.0 Loading Operations.....	128
13.0 Tier 4 CEMS Information	131
14.0 Facility-Level Roll-up Emissions.....	139
IV. Appendix A – Sample XML Document for Subpart Y.....	141

List of Tables

	<u>Page</u>
Table 1 Reporting Numbers.....	2
Table 2 Calculated Details Data Element Definitions	5
Table 3 Measurement Details Data Element Definitions	6
Table 4 Unit Identification Details Data Element Definitions.....	6
Table 5 Summary of Changes to the Schema for Subpart Y	9
Table 6 Required Subpart-Level Summary Data.....	13
Table 7 Greenhouse Gas Information Details Data Element Definitions	16
Table 8 Flare Gas Unit Details Data Element Definitions.....	19
Table 9 Flare Gas Emissions Details Data Element Definitions	21
Table 10 Flare Gas Carbon Fraction Basis Data Element Definitions	22
Table 11 Y1aEquationDetails Data Element Definitions	26
Table 12 Y1bEquationDetails Data Element Definitions.....	30
Table 13 Y2EquationDetails Data Element Definitions	33
Table 14 Y3EquationDetails Data Element Definitions	36
Table 15 Cracking Coking Reforming Unit Data Element Definitions.....	38
Table 16 Cracking Coking Reforming Emissions Data Element Definitions	41
Table 17 Equation Y-6 Details Data Element Definitions.....	45
Table 18 Equation Y-7a Details Data Element Definitions.....	49
Table 19 Equation Y-7b Details Data Element Definitions.....	52
Table 20 Equation Y-8 Details Data Element Definitions.....	55
Table 21 Equation Y-11 Data Element Definitions.....	56
Table 22 Cracking Coking CEMS Details Data Element Definitions.....	57
Table 23 Sour Gas Sent Off-site Data Element Definitions	59
Table 24 Sulfur Recovery Unit Details Data Element Definitions.....	62
Table 25 Process Vent Method Details Data Element Definitions.....	64
Table 26 Mole Fraction Details Data Element Definitions	67
Table 27 Equation Y-12 Details Data Element Definitions.....	69
Table 28 Recycle Tail Gas Details Data Element Definitions.....	72
Table 29 Sulfur Recovery Unit CEMS Details Data Element Definitions	76
Table 30 Coke Calcining Unit Details Data Element Definitions	78
Table 31 Coke Calcining Emissions Details Data Element Definitions.....	80
Table 32 Coke Calcining Unit Method Details Data Element Definitions.....	82
Table 33 Coke Calcining CEMS Details Data Element Definitions	84
Table 34 Asphalt Blowing Unit Details Data Element Definitions	86
Table 35 Equations Y-14 and Y-15 Details Data Element Definitions	88
Table 36 Equation Y-17 Details Data Element Definitions.....	91
Table 37 Process Vent Method Details Data Element Definitions.....	94
Table 38 Mole Fraction Details Data Element Definitions	96
Table 39 Delayed Coking Details (Subpart-Level) Data Element Definitions.....	98
Table 40 Delayed Coking Unit Details Data Element Definitions	100
Table 41 Coking Drums Set Details Data Element Definitions	101

List of Tables (continued)

	<u>Page</u>
Table 42 Process Vents Unit Details Data Element Definitions.....	104
Table 43 Intermittent Vents Details Data Element Definitions	107
Table 44 Mole Fraction Details Data Element Definitions	109
Table 45 UnControlledBlowDownDetails Data Element Definitions.....	112
Table 46 Process Vent Method Details Data Element Definitions.....	114
Table 47 Mole Fraction Details Data Element Definitions	116
Table 48 Basis for CH ₄ Emissions Factor Data Element Definitions.....	117
Table 49 Equipment Leaks Details Data Element Definitions	119
Table 50 Storage Tanks (Stabilized Crude) Data Element Definitions	122
Table 51 Storage Tanks (Unstabilized Crude) Data Element Definitions	125
Table 52 Loading Operations Details Data Element Definitions	129
Table 53 Tier 4 CEMS Location and Emissions Details Data Element Definitions	133
Table 54 Tier 4 CEMS Quarter and Additional Details Data Element Definitions.....	135
Table 55 Tier 4 CEMS Process Units Details Data Element Definitions.....	138
Table 56 Facility-Level Roll-up Emissions Data Element Definitions	140

List of Figures

	<u>Page</u>
Figure 1	3
Figure 2	5
Figure 3	5
Figure 4	6
Figure 5	7
Figure 6	8
Figure 7	11
Figure 8	14
Figure 9	15
Figure 10	18
Figure 11	20
Figure 12	24
Figure 13	28
Figure 14	28
Figure 15	32
Figure 16	35
Figure 17	37
Figure 18	39
Figure 19	44
Figure 20	48
Figure 21	51
Figure 22	54
Figure 23	56
Figure 24	57
Figure 25	58
Figure 26	61
Figure 27	64
Figure 28	66
Figure 29	68
Figure 30	70
Figure 31	76
Figure 32	77
Figure 33	79
Figure 34	84
Figure 35	85
Figure 36	88
Figure 37	90
Figure 38	93
Figure 39	95
Figure 40	97
Figure 41	99

List of Figures (continued)

	<u>Page</u>
Figure 42 Process Vents Details (Unit-Level) Schema Diagram.....	103
Figure 43 Intermittent Vents Details Schema Diagram	107
Figure 44 Mole Fraction Details Schema Diagram.....	108
Figure 45 Uncontrolled Blowdown Details Schema Diagram.....	111
Figure 46 Process Vent Method Details Schema Diagram	113
Figure 47 Mole Fraction Details Schema Diagram.....	115
Figure 48 Equipment Leaks Details Schema Diagram	118
Figure 49 Storage Tanks (Stabilized Crude) Schema Diagram	121
Figure 50 Storage Tanks (Unstabilized Crude) Schema Diagram	123
Figure 51 Unstabilized Methane Composition Method Details Schema Diagram	124
Figure 52 Loading Operations Details Schema Diagram.....	128
Figure 53 Vessel Details Schema Diagram.....	128
Figure 54 Tier 4 CEMS Details Schema Diagram.....	131
Figure 55 Tier 4 CEMS Location and Emissions Details Schema Diagram.....	132
Figure 56 Tier 4 CEMS Quarter and Additional Details Schema Diagram.....	134
Figure 57 Tier 4 CEMS Quarter and Additional Details Schema Diagram.....	137
Figure 58 Facility-Level Roll-up Emissions Schema Diagram	139

List of XML Excerpts

		<u>Page</u>
XML Excerpt 1	Example for “Unbounded” Parent Element.....	7
XML Excerpt 2	Example for Greenhouse Gas Information Details.....	17
XML Excerpt 3	Example for Flare Details if Facility does not have a Flare	19
XML Excerpt 4	Example for Flare Detail	20
XML Excerpt 5	Example for Flare Gas Emissions Details	22
XML Excerpt 6	Example for Flare Gas Carbon Fraction Basis	22
XML Excerpt 7	Example for Equation Y-1a.....	27
XML Excerpt 8	Example for Equation Y-1b.....	31
XML Excerpt 9	Example for Equation Y-2.....	34
XML Excerpt 10	Example for Equation Y-3.....	36
XML Excerpt 11	Example for Cracking Coking Reforming Unit Details	39
XML Excerpt 12	Example for Cracking Coking Emissions.....	43
XML Excerpt 13	Example for Equation Y-6.....	46
XML Excerpt 14	Example for Equation Y-7a.....	50
XML Excerpt 15	Example for Equation Y-7b.....	54
XML Excerpt 16	Example for Equation Y-8.....	55
XML Excerpt 17	Example for Equation Y-11.....	56
XML Excerpt 18	Example for Cracking Coking CEMS Details.....	57
XML Excerpt 19	Example for Sour Gas Sent Off-site	60
XML Excerpt 20	Example for Sulfur Recovery Units	63
XML Excerpt 21	Example for Process Vent Method Details.....	65
XML Excerpt 22	Example for Mole Fraction Details	67
XML Excerpt 23	Example for Equation Y-12 Details	70
XML Excerpt 24	Example for Recycled Tail Gas Details (Default Correction Factor).....	75
XML Excerpt 25	Example for Recycled Tail Gas Details (Unit-Specific Correction Factor)	75
XML Excerpt 26	Example for Sulfur Recovery Unit CEMS Details.....	76
XML Excerpt 27	Example for Coke Calcining Unit Details	78
XML Excerpt 28	Example for Coke Calcining Emissions Details.....	81
XML Excerpt 29	Example for Coke Calcining Unit Method Details.....	83
XML Excerpt 30	Example for Coke Calcining CEMS Details	84
XML Excerpt 31	Example for Asphalt Blowing Unit Details.....	87
XML Excerpt 32	Example for Equations Y-14 and Y-15 Details.....	89
XML Excerpt 33	Example for Equation Y-17 and Y-16a Details.....	92
XML Excerpt 34	Example for Equation Y-17 and Y-16b Details.....	92
XML Excerpt 35	Example for Process Vent Method Details.....	94
XML Excerpt 36	Example for Mole Fraction Details	96
XML Excerpt 37	Example for Delayed Coking Details (Subpart-Level).....	98
XML Excerpt 38	Example for Delayed Coking Unit Details.....	100
XML Excerpt 39	Example for Coking Drums Set Details	102
XML Excerpt 40	Example for Process Vents Unit Details	107
XML Excerpt 41	Example for Intermittent Vents Details.....	108

List of XML Excerpts (continued)

	<u>Page</u>
XML Excerpt 42 Example for Mole Fraction Details	110
XML Excerpt 43 Example for Uncontrolled Blowdown System Details.....	112
XML Excerpt 44 Example for Process Vent Method Details.....	114
XML Excerpt 45 Example for Mole Fraction Details	116
XML Excerpt 46 Example for Basis for CH ₄ Emissions Factor.....	117
XML Excerpt 47 Example for Equipment Leaks	120
XML Excerpt 48 Example for Storage Tanks (Stabilized Crude)	123
XML Excerpt 49 Example for Storage Tanks (Unstabilized Crude).....	127
XML Excerpt 50 Example for Loading Operations Details	130
XML Excerpt 51 Example for Tier 4 CEMS Location and Emissions Details	134
XML Excerpt 52 Example for Y Tier 4 CEMS Quarter and Additional Details.....	137
XML Excerpt 53 Example for Tier 4 CEMS Process Units Details.....	138
XML Excerpt 54 Example for Facility-Level Roll-up Emissions	140

[This page intentionally left blank]

I. Introduction

The U.S. Environmental Protection Agency's (EPA's) electronic greenhouse gas reporting tool (e-GGRT) extensible markup language (XML) Reporting Schema contains all of the data elements needed to comply with the Greenhouse Gas Reporting Program (GHGRP) beginning with the 2010 data collection year. The XML schema defines expected data elements and attributes, allowable data formats for each data element, and the hierarchical structure and sequence in which data elements must appear in the XML file. Similar to an architectural blueprint that describes the structural design of a house, an XML schema describes the structural design of an XML file. In some cases, it also defines which elements are optional and which are required and the maximum number of occurrences allowed for each element.

The e-GGRT XML schema is made up of a root data element (GHG) and complex and simple data elements. A simple element is a single piece of data. A complex element is a group of simple elements which are logically grouped together. The root data element is the base of the XML schema.

The data elements are related to each other in parent-child relationships. The root data element is the parent of the entire schema. Complex data elements are children of the root element, and complex elements can also be children of other complex elements. If a complex element is dependent on a parent complex element, the child complex element cannot be included in the XML file unless the appropriate parent complex element is also included.

The XML upload method may be used for reporting a facility or supplier's annual greenhouse gas (GHG) data; however, the following actions can only be performed using the e-GGRT web forms:

- User, facility and supplier registration
- Certificate of Representation and Notice of Delegation signing
- Facility representative and agent changes
- Facility and supplier address changes
- Notice of intent to not submit an annual GHG report

All XML files submitted to e-GGRT must be well formed and will be accepted only if they conform to the current version of the e-GGRT XML schema.

An XML submission must only contain GHG data for a single facility or supplier. All data for a facility or supplier must be submitted in a single file as a complete report and must include all of the relevant Subparts. It is not possible to submit a subset of any portion of a facility's data to add, delete, correct or update. The entire report must be resubmitted to make any modification at all. Each subsequent submission for the same facility replaces all of the previously submitted data.

The e-GGRT XML schema contains enumerated lists of the units of measures for some data elements and allowable values for some data elements. For rules regarding the unit of measure or allowable values for a specific data element, please refer to the appropriate Data Element Definitions table.

The e-GGRT XML Reporting Schema is available for download at the e-GGRT help website: <http://www.ccdsupport.com/confluence/display/help/XML+Reporting+Instructions>. The zip file contains:

- **GHG_Final.xsd and Included Files**
- **SchemaChanges.xlsx**

Table 1
Reporting Numbers

Number Format	Description
Rounding	<ul style="list-style-type: none"> • CO₂e and CO₂ emissions data expressed in metric tons should be rounded to one decimal place. This should be done regardless of the level of data collection (e.g., unit-level, facility-level). Quantities less than 0.05 metric tons would round to 0.0 and be reported as such. Quantities greater than or equal to 0.05 metric tons would round up to 0.1 and be reported as such. • CH₄ emissions data expressed in metric tons should be rounded to two decimal places. • N₂O emissions data expressed in metric tons should be rounded to three decimal places. • Emissions data for all GHGs other than CO₂, N₂O, and CH₄ expressed in metric tons should be rounded to the fourth digit to the right of the decimal (one tenth of a kilogram, or 1 ten thousandth of a metric ton). This rounding should be applied regardless of the level of data collection (unit, facility, etc.). • Other (non-emissions) quantitative data reported by the user (e.g., a monthly HHV sample result, an annual production quantity) will not need to be rounded. • In the case of aggregation/roll-ups, those calculations should be performed on the rounded values.
Percentages	If a value must be reported as a percentage, then the number should be within the range of 0 to 100 (percent), e.g. 85.5% should be reported as 85.5.
Fractions	If a value must be reported as a decimal fraction, then the number should be within the range of 0 and 1, e.g., 1/4 should be reported as 0.25. Leading zeroes are optional.

Key XML Terms

- **XML:** A markup language for documents containing structured information. The XML specification defines a standard way to add markup to documents. Its primary purpose is to facilitate the sharing of structured data across different information systems, particularly via the internet.
- **XML Schema:** An XML schema describes the structure of an XML document. The schema also defines the set of rules to which the XML document must conform in order to be considered "valid".
- **XML file:** A file containing data organized into a structured document using XML markup.
- **Data Element:** An XML data element is used for storing and classifying data in an XML file. Opening and closing tags represent the start and end of a data element. An opening tag looks like <elementName>, while a closing tag has a slash that is placed before the element's name </elementName>. The following example shows how to report the facility's identification

number: <FacilitySiteIdentifier>23222</FacilitySiteIdentifier>. The information shaded in blue represents the data element's value.

If a data element does not contain a value, then a single empty tag name may be used. An empty tag has a slash placed after the element's name <FacilitySiteIdentifier/>. **Note:** If you do not intend to report a value for a particular data element, then it is recommended that you do not include the data element in the XML file.

- **Attribute:** An XML attribute contains additional information about a specific data element. An attribute for a data element is placed within the opening tag. The syntax for including an attribute in an element is <elementName attributeName="value">. For example, <TotalCH4CombustionEmissions massUOM="Metric Tons">.
- **Root/Parent/Child Element:** The schema's structure can be thought of as a family tree. At the top of the tree is some early ancestor and at the bottom of the tree are the latest children. With a tree structure you can see which children belong to which parents and many other relationships.

XML data elements are sometimes referenced in terms of how they relate to each other, e.g., parent-child relationships, within the schema's tree structure, also known as hierarchy. The top of the XML tree is considered the root – it is the parent to all data elements within the schema. In the example below, "GHG_Unit_Details" is the root, and just like in many other family trees, there is more than one item with the same name (e.g., "Unit_ID"). The easiest way to distinguish these items is by referencing them in terms of their parent-child relationships, e.g., NoCEMS /Unit_ID vs. CEMS/Unit_ID.

Figure 1
Example of an XML Tree

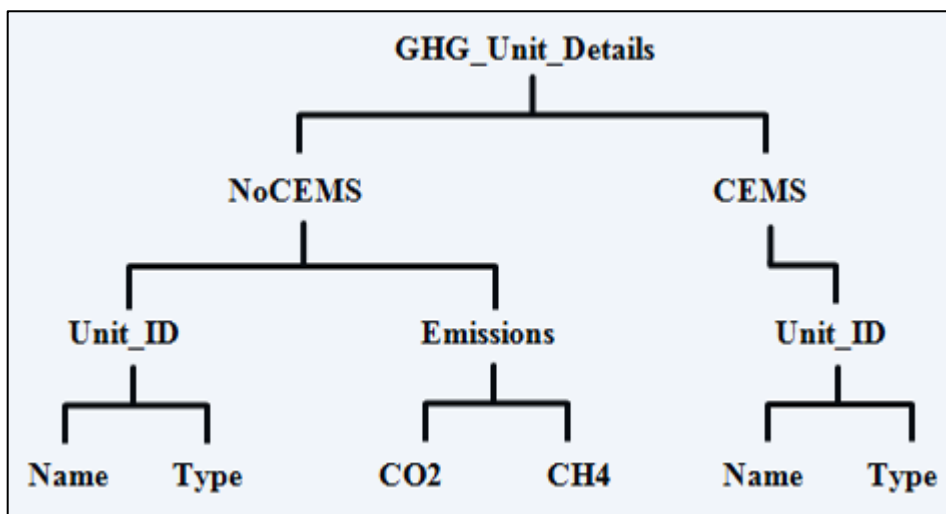

This document provides a step-by-step description of how to report emissions data using the XML schema. Please note the following:

- **Non-applicable data elements should not be included in the facility's XML file.** The schema contains many data elements, some of which may not be applicable to XML reporters in general or to a particular situation. If a data element is not referenced in the instructions (definition tables), then **do not** report or include it in the facility's XML file.
- **Data elements must be reported in a specific order.** The figures and tables in this document depict the specific sequence in which data elements must be arranged in the facility's XML file in order to produce a well-formed XML report.
- **Enumerations are case sensitive.** Many data elements have a defined set of allowable values, also known as enumerations. Values for enumerations must be entered exactly as they are defined within the schema (including punctuation marks) in order to be accepted by schema validation. See the definition tables for a complete list of enumerations.
- **Schema diagrams depict the hierarchy (or tree structure).** The primary purpose of the schema diagrams is to indicate the sequence in which data elements must appear within the facility's XML file and to identify the data elements that are required (must be reported) and conditionally required (see last bullet). Required data elements are boxed in red and conditionally required data elements are noted.
- **Definition tables provide details for required and conditionally required data elements.** The tables are designed to provide unique instructions for reporting a given data element, including the list of enumerations and required units of measure, if defined. As noted above, there are some data elements in the schema that are not applicable to XML reporters or to a particular situation. For example, the "OverrideIndicator" data element is used solely by e-GGRT to indicate that the web form reporter chose to override the system's calculated value with their own. These non-applicable data elements **are not** included in the definition tables. If a data element is not referenced in a definition table, then **do not** report or include it in the facility's XML file.
- **Commonly used data types are not depicted in the schema diagrams nor listed separately in the definition tables.** The schema diagrams display almost every data element in the schema except those that are associated with the three most commonly occurring data types:
 - Calculated Details
 - Measurement Details
 - Unit Identification Details

Once defined, these data types (static collection of data elements) are then associated as children to every data element in the schema containing a measured or calculated value or unit details. These child data elements do not appear in the diagrams and are not listed on separate rows in the definition tables in order to reduce their redundancy. They are however, referenced in the tables in the description of their parent data element. See Figures 2-4 and Tables 2-4.

- **Some data elements are conditionally required.** Data elements which are conditionally required are noted in the schema diagrams and the data element definitions tables. If your facility meets the condition specified for the data element, then the data element is required and you must report it in the facility's XML file. If your facility does not meet the condition specified for the data element, then **do not** include the data element in the facility's XML file. If a parent element is not required, then **do not** include any of its child data elements in the facility's XML file.

Figure 2
Calculated Details Data Type Schema Diagram

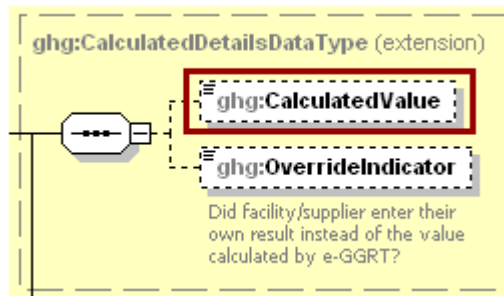

Note: Data elements boxed in red are required.

Table 2
Calculated Details Data Element Definitions

Data Element Name	Description
CalculatedDetailsDataType	
CalculatedValue	Calculated value (decimal).
OverrideIndicator	Note: Do not include this data element in the facility’s XML file because it only applies to web form reporters. It is a flag set by e-GGRT to indicate that the system-calculated value was overridden with the web form reporter’s value.

Figure 3
Measurement Details Data Type Schema Diagram

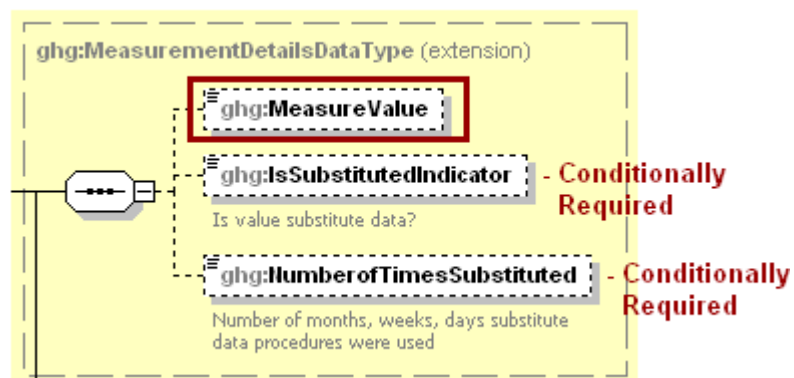

Note: Data elements boxed in red are required. Please see page 4 of this document for more information on conditionally required elements.

Table 3
Measurement Details Data Element Definitions

Data Element Name	Description
MeasurementDetailsDataType	
MeasureValue	Measured value (decimal).
IsSubstitutedIndicator	An indication (Y/N) that the measure value contains substituted data. Note: Do not include this data element in your XML file unless noted in the instructions for the particular measured value.
NumberOfTimesSubstituted	The number (integer) of days, months, weeks, or hours in the reporting year that missing data procedures were followed. Note: Do not include this data element in your XML file unless noted in the instructions for the particular measured value.

Figure 4
Unit Identification Details Data Type Schema Diagram

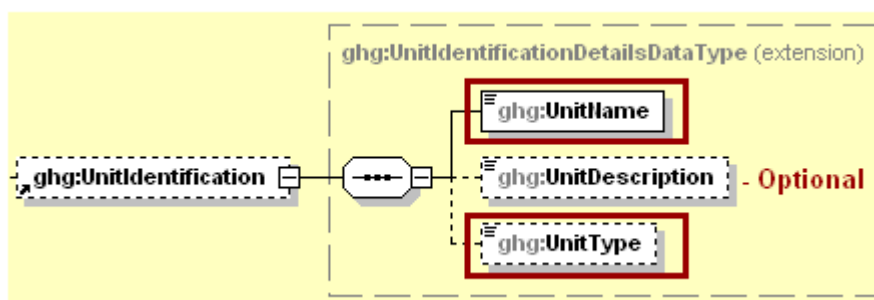

Note: Data elements boxed in red are required.

Table 4
Unit Identification Details Data Element Definitions

Data Element Name	Description
UnitIdentificationDetails	
UnitName	A unique name (ID) for each unit so that the data for different units can be recorded, maintained and retrieved clearly.
UnitDescription	Optional brief description of the unit.
UnitType	The type of unit. The list of allowable values varies. For more information, see the instructions for the specific unit process to be reported. For example, if reporting Flare Gas details, the unit type would be “Flare”.

The XML symbol “1..∞” shown in Figure 5 means that the parent element is “unbounded” so that multiple instances of the parent element can be reported. XML Excerpt 1 shows an example of reporting multiple instances of a parent element.

Figure 5
“Unbounded” Symbol in Schema Diagram

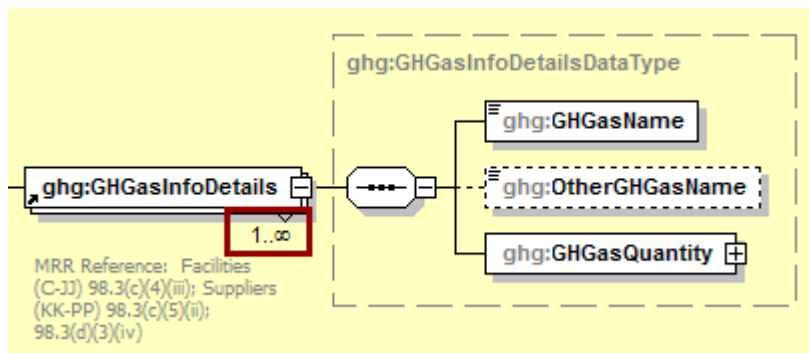

XML Excerpt 1
Example for “Unbounded” Parent Element

```
<ghg:GHGasInfoDetails >
  <ghg:GHGasName>Biogenic Carbon dioxide</ghg:GHGasName>
  <ghg:GHGasQuantity massUOM="Metric Tons">
    <ghg:CalculatedValue>600.1</ghg:CalculatedValue>
  </ghg:GHGasQuantity>
</ghg:GHGasInfoDetails>
<ghg:GHGasInfoDetails >
  <ghg:GHGasName>Methane</ghg:GHGasName>
  <ghg:GHGasQuantity massUOM="Metric Tons">
    <ghg:CalculatedValue>280.23</ghg:CalculatedValue>
  </ghg:GHGasQuantity>
</ghg:GHGasInfoDetails>
<ghg:GHGasInfoDetails >
  <ghg:GHGasName>Nitrous Oxide</ghg:GHGasName>
  <ghg:GHGasQuantity massUOM="Metric Tons">
    <ghg:CalculatedValue>19.456</ghg:CalculatedValue>
  </ghg:GHGasQuantity>
</ghg:GHGasInfoDetails>
<ghg:GHGasInfoDetails >
  <ghg:GHGasName>Carbon Dioxide</ghg:GHGasName>
  <ghg:GHGasQuantity massUOM="Metric Tons">
    <ghg:CalculatedValue>10800.7</ghg:CalculatedValue>
  </ghg:GHGasQuantity>
</ghg:GHGasInfoDetails>
```

The XML symbol for a logical “Or” shown in Figure 6 means that **only one** of the data elements following the symbol can be reported for the current instance of the parent element.

Figure 6
Logical “Or” Symbol in Schema Diagram

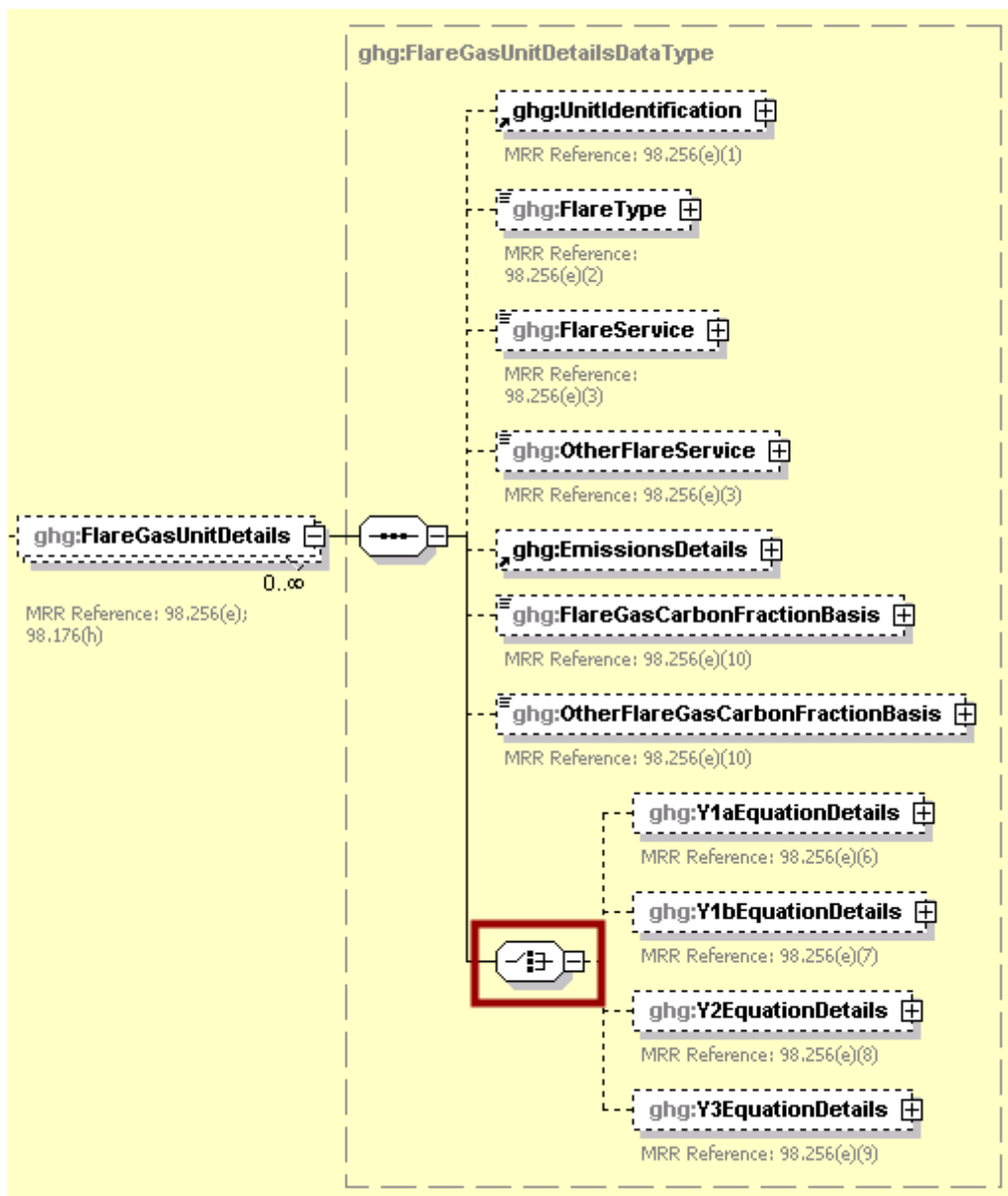

II. Summary of Changes

The following modifications were applied to the previous version of the GHG XML schema in relation to Subpart Y (GHG_SubPartY_v2.0.xsd) for reporting year 2011.

Table 5
Summary of Changes to the Schema for Subpart Y

No.	Change Description
	Global Changes (changes are reflected throughout the schema)
1	Added enumeration "kg/cycle or kg/measurement period" to attribute "rateUOM".
2	Modified enumeration for attribute "fractionUOM". Replaced "kg-moleCF4/kg-molegas" with "kg-moleC/kg-molegas".
	Flare Gas Details Changes
3	Removed enumeration "Other" for data element "FlareType". (XPath = FlareGasDetails/FlareGasUnitDetails)
4	Added enumeration "Default Value" for data element "FlareGasCarbonFractionBasis". (XPath = FlareGasDetails/FlareGasUnitDetails)
	Cracking Coking Reforming Details Changes
5	Added new attribute "rateUOM" to data element "MaximumRatedThroughputofUnit". (XPath = CrackingCokingReformingDetails/CrackingCokingReformingUnitDetails)
6	Added new child element "AverageCokeBurnOffPerCycle" to "Y11Details". (XPath = CrackingCokingReformingDetails/CrackingCokingReformingUnitDetails/Y11Details)
	Sulfur Recovery Details Changes
7	Removed attribute "rateUOM" from data element "AnnualVolumetricFlow". (XPath = SulfurRecoveryDetails/SourGasDetails)
8	Removed attribute "rateUOM" from data element "AverageMoleFractionofCarboninSourGas". (XPath = SulfurRecoveryDetails/SourGasDetails)
9	Added new child element "MoleFractionDetails" to "ProcessVentMethodDetails". (XPath = SulfurRecoveryDetails/SulfurRecoveryUnitDetails/ProcessVentMethodDetails)

No.	Change Description
10	Removed attribute “ rateUOM ” from data element “ AnnualVolumetricFlow ”. (XPath = SulfurRecoveryDetails/SulfurRecoveryUnitDetails)
11	Removed attribute “ rateUOM ” from data element “ AverageMoleFractionofCarboninSourGas ”. (XPath = SulfurRecoveryDetails/SulfurRecoveryUnitDetails)
12	The attribute “ volUOM ” was made optional for data element “ RecycleTailGasVolme ”. (XPath = SulfurRecoveryDetails/SulfurRecoveryUnitDetails/RecycleTailGasDetails/RecycleTailGas Volume)
Asphalt Blowing Details Changes	
13	Added data type “ ProcessVentMethodDetails ” to “AsphaltBlowingUnitDetails”. (XPath = AsphaltBlowingDetails/AsphaltBlowingUnitDetails)
14	Added enumeration “ Equation Y-19 (Process Vent) ” for data element “ AsphaltCO2EmissionsMethodList ” and updated MRR reference. (XPath = AsphaltBlowingDetails/AsphaltBlowingUnitDetails)
Storage Tank Details Changes	
15	For data element “ CH4VaporCompositionData ”, the following changes were made: <ul style="list-style-type: none"> • The attribute “rateUOM” was removed. • Child data element “MeasureValue” removed. • Child data element “IsSubstituedIndicator” removed. (XPath = StorageTankDetails/UnstabilizedMethaneCompositionMethodDetails)
16	Added MRR reference to data element “ OtherCH4VaporCompositionDataMethod ”. (XPath = StorageTankDetails/UnstabilizedMethaneCompositionMethodDetails)
17	For data element “ GasGenerationRateData ”, the following changes were made: <ul style="list-style-type: none"> • The attribute “rateUOM” was removed. • Child data element “MeasureValue” removed. • Child data element “IsSubstituedIndicator” removed. (XPath = StorageTankDetails/UnstabilizedMethaneCompositionMethodDetails)
18	For data element “ GasGenerationRateDataMethod ”, the enumerations were modified. (XPath = StorageTankDetails/UnstabilizedMethaneCompositionMethodDetails)
19	Added new data element “ GasGenerationRateDataMethodOther ”. (XPath = StorageTankDetails/UnstabilizedMethaneCompositionMethodDetails)

Document Changes:

3-9-2012 – Modified some of the emissions values within the XML excerpts to emphasize the rounding rules, see [Table 1](#).

3-19-2012 - Added “ParentCompanyDetails” to sample XML document. Separated schema change 17 into 17 and 18 in Table 5. Updated XML excerpts and sample XML based on schema changes.

III. Subpart Y Overview

This section provides a step-by-step description of how to report emissions data from petroleum refineries as required by Subpart Y of the GHGRP using the XML schema.

Figure 7
Subpart Y Reporting Diagram

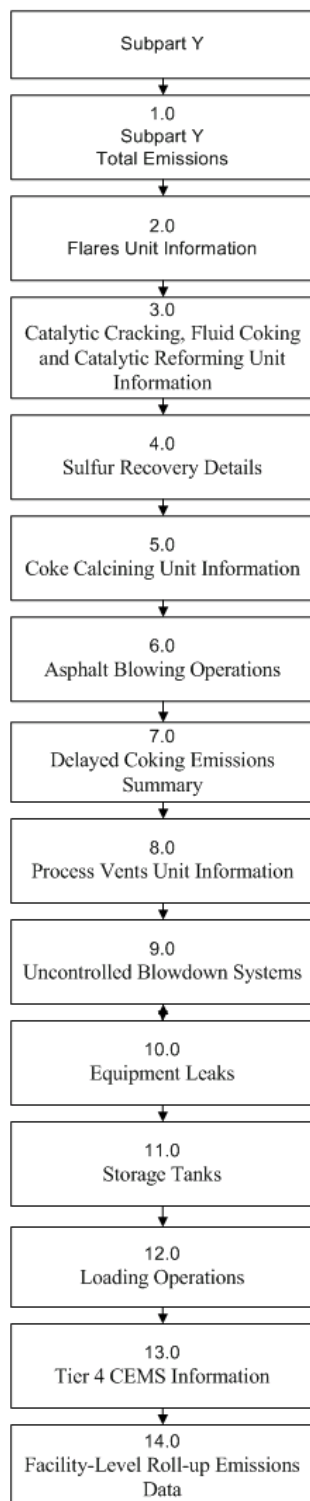

The XML schema includes the following areas for reporting for Subpart Y, as shown in the reporting diagram:

- 1.0 Subpart Y Total Emissions: includes the total emissions of CO₂ (excluding biogenic CO₂), biogenic CO₂, CH₄ and N₂O as reported under Subpart Y.
- 2.0 Flares Unit Information: includes emissions information and calculation method details for each flare unit.
- 3.0 Catalytic Cracking, Fluid Coking and Catalytic Reforming Unit Information: includes emissions information and calculation method details for each catalytic cracking, fluid coking and catalytic reforming unit.
- 4.0 Sulfur Recovery Details: includes subpart-level summary data for CO₂ emissions from sour gas sent off-site and emissions and associated details for each sulfur recovery unit.
- 5.0 Coke Calcining Unit Information: includes emissions information and calculation method details for each coke calcining unit.
- 6.0 Asphalt Blowing Operations: includes emissions information and calculation method details for each asphalt blowing unit.
- 7.0 Delayed Coking Emissions Summary: includes subpart-level summary data for cumulative CH₄ emissions from all delayed coking units and emissions and details for each delayed coking unit.
- 8.0 Process Vents Unit Information: includes emissions information and calculation method details for each process vent unit.
- 9.0 Uncontrolled Blowdown Systems: includes subpart-level summary data for CH₄ emissions from uncontrolled blowdown systems.
- 10.0 Equipment Leaks: includes subpart-level summary data for CH₄ emissions from equipment leaks.
- 11.0 Storage Tanks: includes subpart-level summary data for annual CH₄ emissions from unstabilized crude oil storage and stored liquids other than unstabilized crude oil.
- 12.0 Loading Operations: includes subpart-level summary data for cumulative annual CH₄ emissions (in metric tons of each pollutant emitted) for loading operations.
- 13.0 Tier 4 CEMS Information: includes emissions data for each CEMS monitoring location.
- 14.0 Facility-Level Roll-up Emissions Data: includes information on how to add Subpart Y emissions to the facility-level emissions for CO₂e (excluding biogenic CO₂) and biogenic CO₂. These are aggregated across all source category Subparts associated with the facility.

If your facility is subject to reporting under Subpart Y (Petroleum Refineries), EPA recommends that you also consider the following source categories in your facility applicability determination: Subpart C (General Stationary Fuel Combustion), Subpart P (Hydrogen Production) and Subpart MM (Suppliers of Petroleum Products). These source categories are only provided as suggestions - additional Subparts may be relevant for a given facility/supplier and not all listed Subparts are relevant for all facilities/suppliers.

A petroleum refinery is any facility engaged in producing gasoline, gasoline blending stocks, naphtha, kerosene, distillate fuel oils, residual fuel oils, lubricants, or asphalt (bitumen) by the distillation of petroleum or the redistillation, cracking, or reforming of unfinished petroleum derivatives.

Reporters of the affected facilities are required to report greenhouse gas (GHG) emissions from the following sources: flares, catalytic cracking units, traditional fluid coking units, fluid coking units with

flexicoking design, delayed coking units, catalytic reforming units, sulfur recovery units, coke calcining units, asphalt blowing, equipment leaks, storage tanks, uncontrolled blowdown systems, loading operations, process vents and non-merchant hydrogen plants.

Note: If you are using a Best Available Monitoring Method (BAMM) in accordance with the rule in place of a method in Subpart Y, you should report the "Other" option for the method data element and report "BAMM" or "Best Available Monitoring Method" for the corresponding "Other" data element. Details regarding BAMM methods used should be included in Subpart A.

Table 6
Required Subpart-Level Summary Data

Section	Subpart-Level Summary Data
1.0	Subpart Y Total Emissions
2.0	Flares Unit Information
4.1	Sour Gas Sent Off-site
7.1	Subpart Level Delayed Coking Details
7.3	Coking Drums Set Details
9.0	Uncontrolled Blowdown Systems
10.0	Equipment Leaks
11.0	Storage Tanks
12.0	Loading Operations
14.0	Facility-Level Roll-up Emissions

Figure 8
Subpart Y Schema Diagram

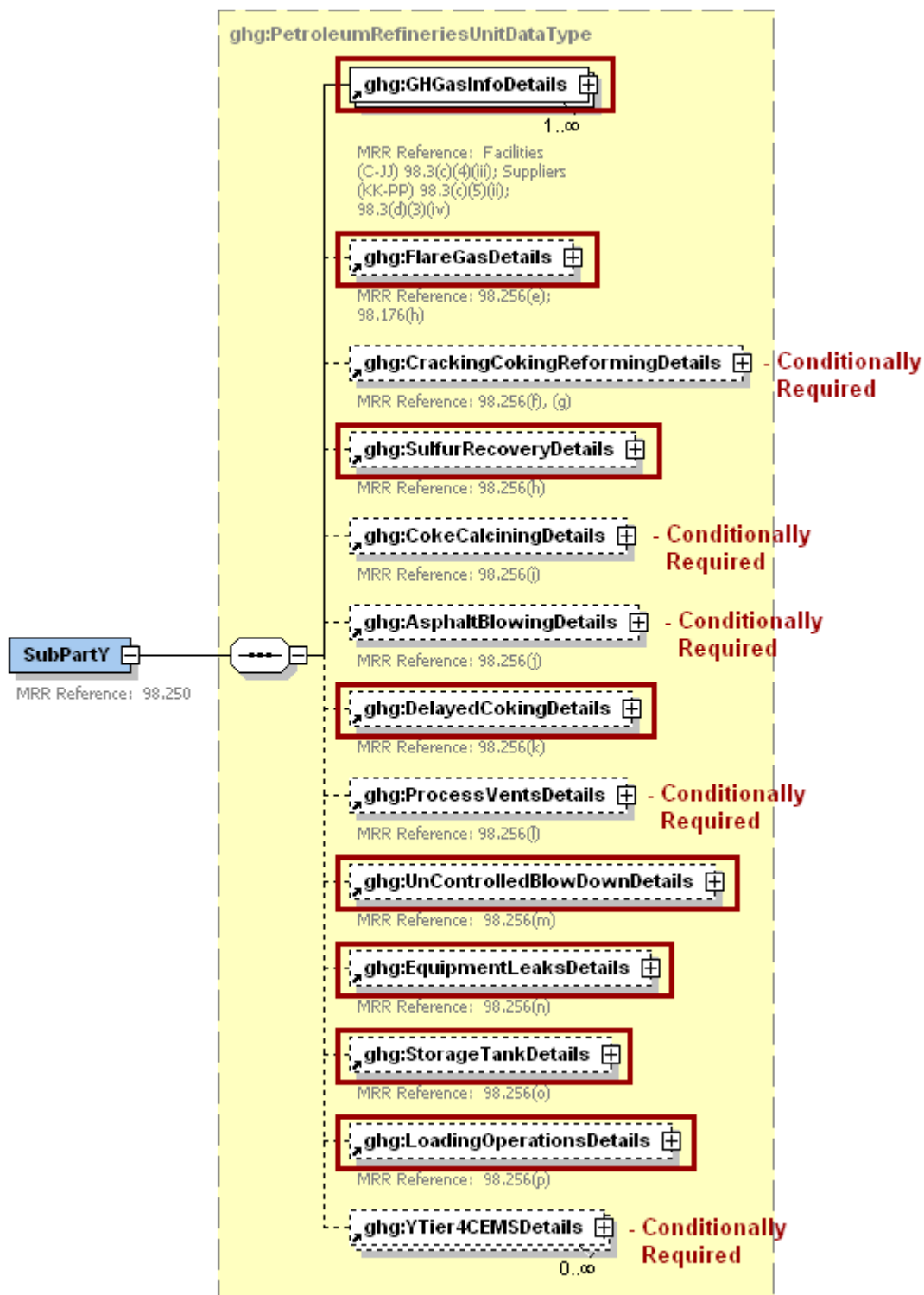

Note: Data elements boxed in red are required. Please see page 4 of this document for more information on conditionally required elements.

1.0 Subpart Y Total Emissions

Required Subpart-Level Summary Data

Greenhouse gas information details comprise a collection of data elements to report the total annual emissions of each greenhouse gas (GHG) listed in Table A-1 of 40 CFR 98 Mandatory Reporting of Greenhouse Gases, reported under Subpart Y, expressed in metric tons.

Figure 9
Greenhouse Gas Information Details Schema Diagram

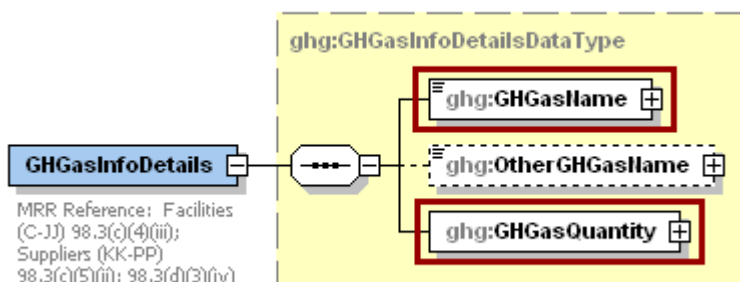

Note: Data elements boxed in red are required.

The GHGasInfoDetails parent element is for reporting emissions rolled up to the Subpart level. For Subpart Y, report total emissions for carbon dioxide (excluding biogenic CO₂), biogenic CO₂, methane (CH₄) and nitrous oxide (N₂O) using the following guidelines:

- 1) **Total CO₂ emissions (excluding biogenic CO₂):**
 - Add the total annual CO₂ mass emissions measured by the CEMS for each CEMS monitoring location (CML) in metric tons. Then subtract the total annual biogenic CO₂ emissions for each CML in metric tons.
 - Add the annual CO₂ emissions from sour gas sent off-site in metric tons.
 - Add the annual CO₂ emissions from each asphalt blowing unit in metric tons.
 - Add the annual CO₂ emissions from each coke calcining unit in metric tons.
 - Add the annual CO₂ emissions from each coking/cracking/reforming unit in metric tons.
 - Add the annual CO₂ emissions from each flare in metric tons.
 - Add the annual CO₂ emissions from each process vent in metric tons.
 - Add the annual CO₂ emissions from each sulfur recovery plant in metric tons.
- 2) **Total biogenic CO₂ emissions:** Add the total annual biogenic CO₂ mass emissions for each CML in metric tons.
- 3) **Total CH₄ emissions:**
 - Add the total CH₄ emissions measured by the CEMS for each CML in metric tons.
 - Add the total CH₄ emissions from each uncontrolled blowdown system, each stabilized/unstabilized crude storage tank, all equipment leaks, all loading operations and each delayed coking unit in metric tons.
 - Add the annual CH₄ emissions from each asphalt blowing unit in metric tons.
 - Add the annual CH₄ emissions from each coke calcining unit in metric tons.
 - Add the annual CH₄ emissions from each coking/cracking/reforming unit in metric tons.
 - Add the annual CH₄ emissions from each flare in metric tons.
 - Add the annual CH₄ emissions from each process vent in metric tons.
 - Add the total annual CH₄ emissions measured by the CEMS for each coke calcining unit in metric tons.

- Add the total annual CH₄ emissions measured by the CEMS for each coking/cracking/reforming unit in metric tons.
- 4) **Total N₂O emissions:**
- Add the total annual N₂O emissions measured by the CEMS for each CML in metric tons.
 - Add the annual N₂O emissions from each coke calcining unit in metric tons.
 - Add the annual N₂O emissions from each coking/cracking/reforming unit in metric tons.
 - Add the annual N₂O emissions from each flare in metric tons.
 - Add the annual N₂O emissions from each process vent in metric tons.
 - Add the total annual N₂O emissions measured by the CEMS for each coke calcining unit in metric tons.
 - Add the total annual N₂O emissions measured by the CEMS for each coking/cracking/reforming unit in metric tons.

Note: You must follow the rounding rules found in [Table 1](#).

**Table 7
Greenhouse Gas Information Details Data Element Definitions**

Data Element Name	Description
GHGasInfoDetails	Parent Element: A collection of data elements containing the total annual emissions of each greenhouse gas (GHG) listed in Table A-1 of 40 CFR 98 Mandatory Reporting of Greenhouse Gases, or other GHGs reported under this Subpart, expressed in metric tons.
GHGasName	Specify the name of the GHG. See list of allowable values: Carbon Dioxide Biogenic Carbon dioxide Methane Nitrous Oxide
GHGasQuantity	A collection of data elements that quantify the annual emissions from this source category. Report the emissions value in the child data element CalculatedValue . Set the units of measure to “Metric Tons” in the attribute massUOM .

XML Excerpt 2 Example for Greenhouse Gas Information Details

```
<ghg:GHGasInfoDetails>
  <ghg:GHGasName>Biogenic Carbon dioxide</ghg:GHGasName>
  <ghg:GHGasQuantity massUOM="Metric Tons">
    <ghg:CalculatedValue>3234.6</ghg:CalculatedValue>
  </ghg:GHGasQuantity>
</ghg:GHGasInfoDetails>
<ghg:GHGasInfoDetails>
  <ghg:GHGasName>Methane</ghg:GHGasName>
  <ghg:GHGasQuantity massUOM="Metric Tons">
    <ghg:CalculatedValue>89536.24</ghg:CalculatedValue>
  </ghg:GHGasQuantity>
</ghg:GHGasInfoDetails>
<ghg:GHGasInfoDetails>
  <ghg:GHGasName>Nitrous Oxide</ghg:GHGasName>
  <ghg:GHGasQuantity massUOM="Metric Tons">
    <ghg:CalculatedValue>156042.623</ghg:CalculatedValue>
  </ghg:GHGasQuantity>
</ghg:GHGasInfoDetails>
<ghg:GHGasInfoDetails>
  <ghg:GHGasName>Carbon Dioxide</ghg:GHGasName>
  <ghg:GHGasQuantity massUOM="Metric Tons">
    <ghg:CalculatedValue>298375.8</ghg:CalculatedValue>
  </ghg:GHGasQuantity>
</ghg:GHGasInfoDetails>
```

Note: The XML example above is presented here to demonstrate the concept of reporting greenhouse gas emissions data.

2.0 Flares Unit Information

Required Unit-Level Data

This topic provides a step-by-step description of how to report Subpart Y Flares unit information for a facility. You must report CO₂, CH₄ and N₂O combustion emissions from each flare.

Figure 10
Flare Gas Details Schema Diagram

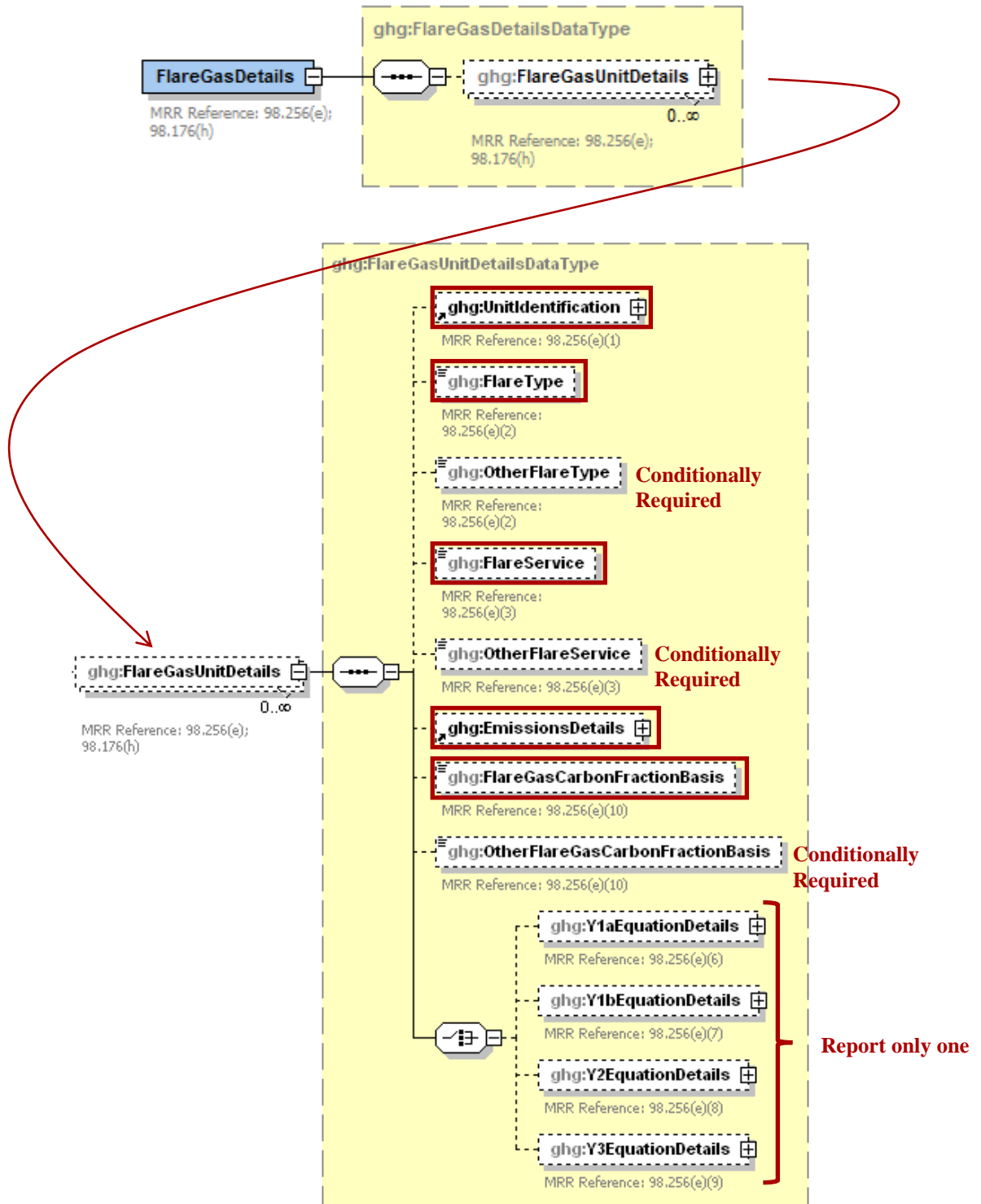

Note: Data elements boxed in red are required. Please see page 4 of this document for more information on conditionally required elements.

Note: If the facility does not have a flare, then report this information in the data element “OtherFlareService” (see excerpt below) and proceed to the next relevant reporting section.

XML Excerpt 3
Example for Flare Details if Facility does not have a Flare

```
<ghg:FlareGasDetails>
  <ghg:FlareGasUnitDetails>
    <ghg:OtherFlareService>Facility does not have a flare</ghg:OtherFlareService>
  </ghg:FlareGasUnitDetails>
</ghg:FlareGasDetails>
```

Note: The XML example above is presented here to demonstrate the concept of reporting flare details if the facility does not have a flare.

Subpart Y collects the following data about your flare unit:

- A unique name or identifier, plus optional description for this flare unit.
- Type of flare.
- Flare service type.
- Details about the methods used to calculate the CO₂ emissions. For more information, see the applicable section:
 - 98.253(b)(1)(ii)(A) – Equation Y-1a – Gas Composition Monitored
 - 98.253(b)(1)(ii)(A) – Equation Y-1b – Gas Composition Monitored
 - 98.253(b)(1)(ii)(B) – Equation Y-2 – Heat Content Monitored
 - 98.253(b)(1)(iii) – Equation Y-3 – Start-up, Shutdown, Malfunction
- The CO₂, CH₄ and N₂O annual emissions for each flare.
- The basis for the fraction of carbon in the flare gas contributed by methane used in Equation Y-4, if applicable.

Table 8
Flare Gas Unit Details Data Element Definitions

Data Element Name	Description
FlareGasDetails	Parent Element
FlareGasUnitDetails	Parent Element
UnitIdentification	A collection of data elements containing the identity of each Flare Gas unit. Report a unique unit name (ID) in the child data element UnitName , an optional brief description in the child data element UnitDescription and the type of unit in the child data element UnitType . [98.256(e)(1)] Report the following unit type: Flare
FlareType	Type of flare. [98.256(e)(2)] Below is the list of allowable values. Steam assisted Air-assisted Unassisted Other (specify)

Data Element Name	Description
OtherFlareType	Conditionally Required: Specify the type of flare if not listed above.
FlareService	Type of flare service. [98.256(e)(3)] Below is the list of allowable values. General facility flare Unit flare Emergency only flare Back-up flare Other (specify)
OtherFlareService	Conditionally Required: Specify the type of flare service if not listed above.

**XML Excerpt 4
Example for Flare Detail**

```

<ghg:FlareGasDetails>
  <ghg:FlareGasUnitDetails>
    <ghg:UnitIdentification>
      <ghg:UnitName>FLARE-001</ghg:UnitName>
      <ghg:UnitDescription>Unit altered to increase the flow.</ghg:UnitDescription>
      <ghg:UnitType>Flare</ghg:UnitType>
    </ghg:UnitIdentification>
    <ghg:FlareType>Steam assisted</ghg:FlareType>
    <ghg:FlareService>General facility flare</ghg:FlareService>
  </ghg:FlareGasUnitDetails>
</ghg:FlareGasDetails>
    
```

Note: The XML example above is presented here to demonstrate the concept of reporting details about a flare gas unit.

**Figure 11
Flare Gas Emissions Details Schema Diagram**

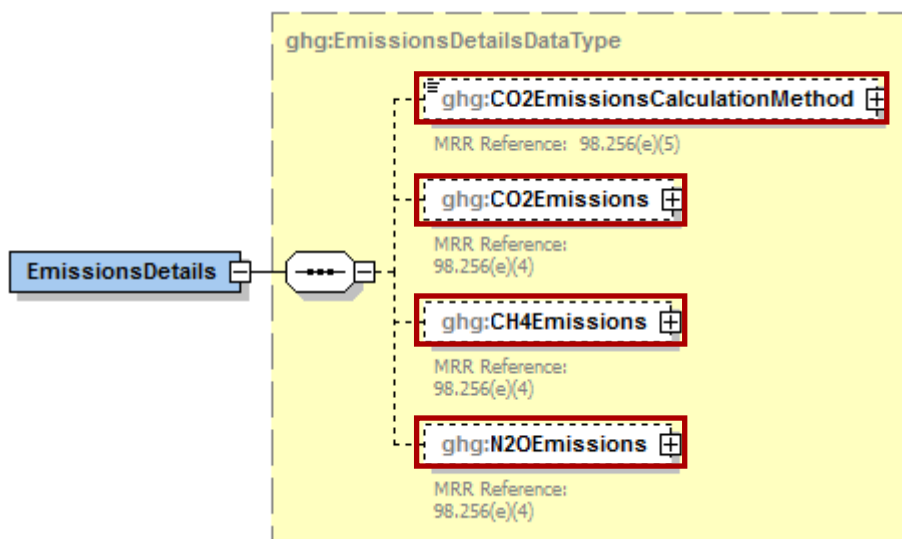

Note: Data elements boxed in red are required. Please see page 4 of this document for more information on conditionally required elements.

Subpart Y collects the following data about your flare unit emissions:

- Method used to calculate the CO₂ emissions.
 - 98.253(b)(1)(ii)(A) - Equation Y-1a Gas Composition Monitored (Equation Y-1a or Y-1b must be used if you have a continuous gas composition monitor on the flare or if you measure it at least weekly.)
 - 98.253(b)(1)(ii)(A) - Equation Y-1b Gas Composition Monitored (Equation Y-1a or Y-1b must be used if you have a continuous gas composition monitor on the flare or if you measure it at least weekly.)
 - 98.253(b)(1)(ii)(B) - Equation Y-2 Heat Content Monitored (Equation Y-2 must be used if you have a continuous higher heating value monitor or measure it at least weekly and the heating value monitor or measurement is not based on compositional analyses; if compositional analyses are used, you must use Equations 1a or 1b.)
 - 98.253(b)(1)(iii) - Equation Y-3 Start-up, Shutdown, Malfunction (Equation Y-3 must be used if you do not measure gas composition or heating value at least weekly.)
- The calculated CO₂, CH₄ and N₂O annual emissions for each flare, expressed in metric tons of each GHG emitted. To report annual CO₂ emissions, follow the instructions that correspond to the calculation method reported. (See applicable section in this document: Equation Y-1a Details, Equation Y-1b Details, Equation Y-2 Details, or Equation Y-3 Details).

Table 9
Flare Gas Emissions Details Data Element Definitions

Data Element Name	Description
EmissionsDetails	Parent Element: The calculated CO ₂ , CH ₄ and N ₂ O annual emissions for each flare.
CO2EmissionsCalculationMethod	The method used to calculate the CO ₂ emissions for each flare (e.g., reference section and equation number). [98.256(e)(5)] Below is the list of allowable values. 98.253(b)(1)(ii)(A) - Equation Y-1a Gas Composition Monitored 98.253(b)(1)(ii)(A) - Equation Y-1b Gas Composition Monitored 98.253(b)(1)(ii)(B) - Equation Y-2 Heat Content Monitored 98.253(b)(1)(iii) - Equation Y-3 Start-up, Shutdown, Malfunction
CO2Emissions	Annual CO ₂ emissions for each flare. [98.256(e)(4)] Report the emissions value in the child data element CalculatedValue . Set the units of measure to “Metric Tons” in the attribute massUOM .
CH4Emissions	Annual CH ₄ emissions for each flare. [98.256(e)(4)] Report the emissions value in the child data element CalculatedValue . Set the units of measure to “Metric Tons” in the attribute massUOM .
N2OEmissions	Annual N ₂ O emissions for each flare. [98.256(e)(4)] Report the emissions value in the child data element CalculatedValue . Set the units of measure to “Metric Tons” in the attribute massUOM .

XML Excerpt 5 Example for Flare Gas Emissions Details

```

<ghg:EmissionsDetails>
  <ghg:CO2EmissionsCalculationMethod>98.253(b)(1)(ii)(A) - Equation Y-1a Gas Composition
  Monitored</ghg:CO2EmissionsCalculationMethod>
  <ghg:CO2Emissions massUOM="Metric Tons">
    <ghg:CalculatedValue>23400.4</ghg:CalculatedValue>
  </ghg:CO2Emissions>
  <ghg:CH4Emissions massUOM="Metric Tons">
    <ghg:CalculatedValue>3880.23</ghg:CalculatedValue>
  </ghg:CH4Emissions>
  <ghg:N2OEmissions massUOM="Metric Tons">
    <ghg:CalculatedValue>2035.234</ghg:CalculatedValue>
  </ghg:N2OEmissions>
</ghg:EmissionsDetails>
    
```

Note: The XML example above is presented here to demonstrate the concept of reporting CO₂, CH₄ and N₂O emissions for each flare gas unit.

The basis for the fraction of carbon in the flare gas contributed by methane used in Equation Y-4 is required.

Table 10 Flare Gas Carbon Fraction Basis Data Element Definitions

Data Element Name	Description
FlareGasCarbonFractionBasis	<p>The basis for the fraction of carbon in the flare gas contributed by CH₄ value. [98.256(e)(10)] Below is the list of allowable values.</p> <p style="margin-left: 40px;">Default Value Method 18 at 40 CFR part 60, appendix A-6 ASTM D1945-03 ASTM D1946-90 (Reapproved 2006) GPA 2261-00 UOP539-97 ASTM D2503-92 (Reapproved 2007) Chromatographic analysis: manufacturer’s instructions Engineering calculations Other (specify)</p>
OtherFlareGasCarbonFractionBasis	<p>Conditionally Required: Specify the basis for the fraction of carbon in the flare gas contributed by CH₄ value if not listed above.</p>





XML Excerpt 6 Example for Flare Gas Carbon Fraction Basis

```

<ghg:FlareGasCarbonFractionBasis>ASTM D1945-03</ghg:FlareGasCarbonFractionBasis>
    
```

Note: The XML example above is presented here to demonstrate the concept of reporting flare gas carbon fraction basis for each flare gas unit.

Which equation was used to calculate CO₂ emissions?

-  If Equation Y-1a was used to calculate CO₂ emissions, see [Section 2.1](#) for instructions on how to report for the parent element “Y1aEquationDetails”.
-  If Equation Y-1b was used to calculate CO₂ emissions, see [Section 2.2](#) for instructions on how to report for the parent element “Y1bEquationDetails”.
-  If Equation Y-2 was used to calculate CO₂ emissions, see [Section 2.3](#) for instructions on how to report for the parent element “Y2EquationDetails”.
-  If Equation Y-3 was used to calculate CO₂ emissions, see [Section 2.4](#) for instructions on how to report for the parent element “Y3EquationDetails”.

2.1 Equation Y-1a Details, Gas Composition Monitored

Conditionally Required: This topic provides a step-by-step description of how to report details about Equation Y-1a. This equation is for calculating CO₂ emissions if you monitor gas composition and measure the molecular weight and carbon content of the flare gas combusted.

Figure 12
Y-1a Equation Details Schema Diagram

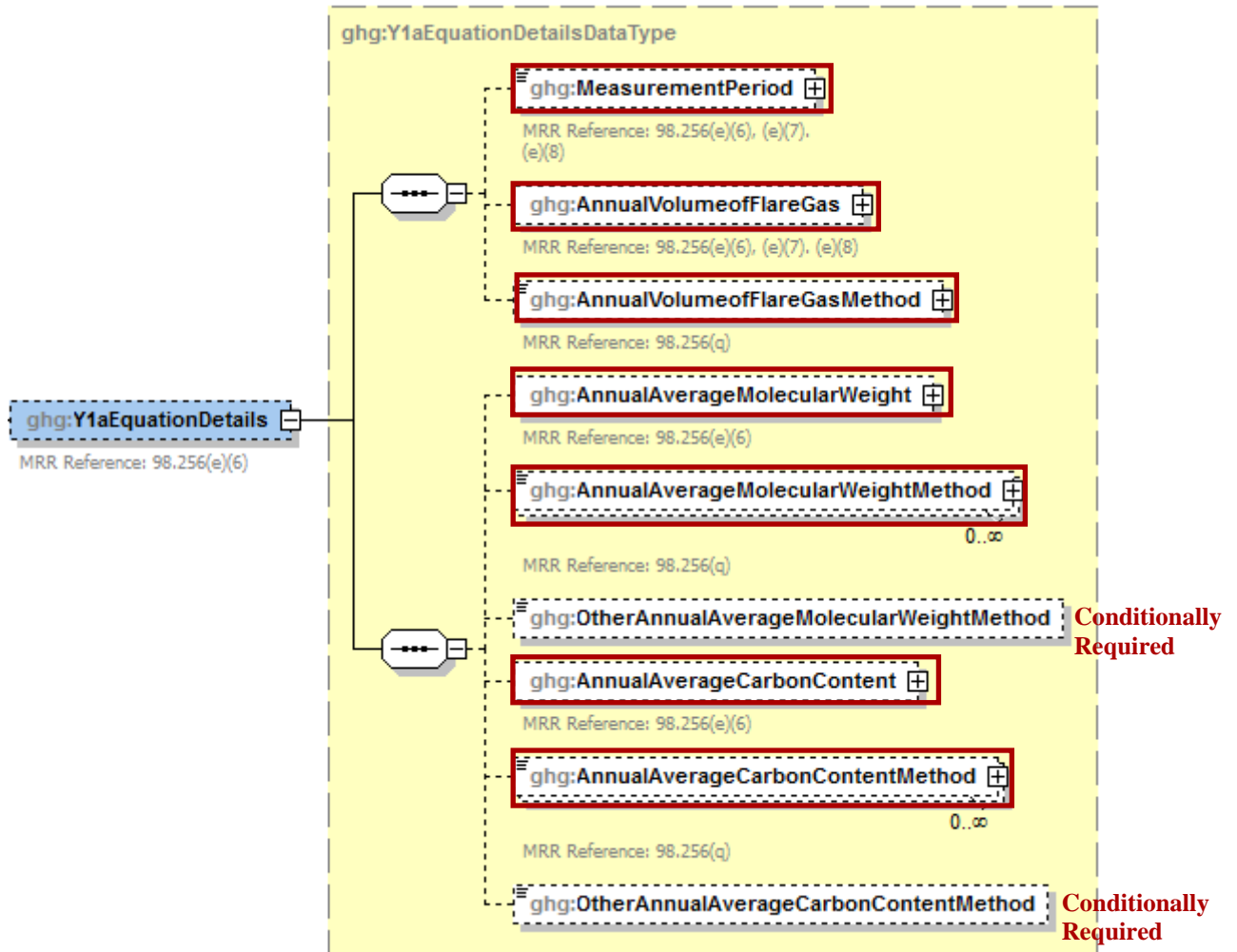

Note: Data elements boxed in red are required. Please see page 4 of this document for more information on conditionally required elements.

To calculate the annual CO₂ emissions from flare units using Equation Y-1a, you can download the Y-1a spreadsheet from the e-GGRT help site or use the following information:

$$CO_2 = 0.98 \times 0.001 \times \left(\sum_{p=1}^n \left[\frac{44}{12} \times \text{Flare}_p \times \frac{MW_p}{MVC} \times CC_p \right] \right)$$

Where:

CO ₂	=	Annual CO ₂ emissions for a specific fuel type (metric tons/year).
0.98	=	Assumed combustion efficiency of a flare.
0.001	=	Unit conversion factor (metric tons per kilogram, mt/kg).
n	=	Number of measurement periods. The minimum value for n is 52 (for weekly measurements); the maximum value for n is 366 (for daily measurements during a leap year).
p	=	Measurement period index.
44	=	Molecular weight of CO ₂ (kg/kg-mole).
12	=	Atomic weight of C (kg/kg-mole).
(Flare) _p	=	Volume of flare gas combusted during measurement period (standard cubic feet per period, scf/period). If a mass flow meter is used, measure flare gas flow rate in kg/period and replace the term “(MW) _p /MVC” with “1”.
(MW) _p	=	Average molecular weight of the flare gas combusted during measurement period (kg/kg-mole). If measurements are taken more frequently than daily, use the arithmetic average of measurement values within the day to calculate a daily average.
MVC	=	Molar volume conversion factor (849.5 scf/kg-mole at 68 °F and 14.7 psia or 836.6 scf/kg-mole at 60 °F and 14.7 psia).
(CC) _p	=	Average carbon content of the flare gas combusted during measurement period (kg C per kg flare gas). If measurements are taken more frequently than daily, use the arithmetic average of measurement values within the day to calculate a daily average.

You must report the following data if you used Equation Y-1a to calculate CO₂ emissions:

- An indication of whether daily or weekly measurement periods are used [98.256(e)(6)]
- The annual volume of flare gas combusted (in scf) [98.256(e)(6)]
- The specific consensus-based standard method number or description of the procedure specified by the flow meter manufacturer [98.256(q)]
- The number of days during the reporting year missing data procedures were used to determine the volume of flare gas combusted [98.3(c)(8)]
- The annual average molecular weight (in kg/kg-mole) [98.256(e)(6)]
- The method used to measure molecular weight [98.256(q)]
- The number of days during the reporting year missing data procedures were used to determine molecular weight [98.3(c)(8)]
- The annual average carbon content of the flare gas (kg carbon/kg flare gas) [98.256(e)(6)]
- The method used to measure carbon content [98.256(q)]
- The number of days during the reporting year missing data procedures were used to determine carbon content [98.3(c)(8)]

Table 11
Y1aEquationDetails Data Element Definitions

Data Element Name	Description
Y1aEquationDetails	Parent Element (Conditionally Required)
MeasurementPeriod	An indication of whether daily or weekly measurement periods are used. [98.256(e)(6)] Below is a list of the allowable values: Daily Weekly
AnnualVolumeofFlareGas	The annual volume of flare gas combusted. [98.256(e)(6)] Report the value in the child data element MeasureValue . Set the units of measure to “scf” in the attribute volUOM . Also report the number of days that missing data procedures were used in measuring the annual volume of flare gas combusted in the child data element NumberofTimesSubstituted . [98.3(c)(8)]
AnnualVolumeofFlareGasMethod	The specific consensus-based standard method or description of the procedure specified by the flow meter manufacturer. [98.256(q)]
AnnualAverageMolecularWeight	The annual average molecular weight. [98.256(e)(6)] Report the value in the child data element MeasureValue . Set the units of measure to “kg/kg-mole” in the attribute molewtUOM . Also report the number of days that missing data procedures were used in measuring the annual average molecular weight in the child data element NumberofTimesSubstituted . [98.3(c)(8)]
AnnualAverageMolecularWeightMethod	The method(s) used to determine the annual average molecular weight of the flare gas. [98.256(q)] Below is the list of allowable values. Method 18 at 40 CFR part 60, appendix A-6 ASTM D1945-03 ASTM D1946-90 (Reapproved 2006) GPA 2261-00 UOP539-97 ASTM D2503-92 (Reapproved 2007) Chromatographic analysis: manufacturer’s instructions Other (specify)
OtherAnnualAverageMolecularWeightMethod	Conditionally Required: Specify the method used to determine the annual average molecular weight of the flare gas if not listed above.
AnnualAverageCarbonContent	The annual average carbon content of the flare gas. [98.256(e)(6)] Report the value in the child data element MeasureValue . Set the units of measure to “decimal fraction; kg carbon/kg flare gas” in the attribute carboncontentUOM . Also report the number of days that missing data procedures were used in measuring the annual average carbon content of the flare gas in the child data element NumberofTimesSubstituted . [98.3(c)(8)]

Data Element Name	Description
AnnualAverageCarbonContentMethod	<p>The method(s) used to determine the annual average carbon content of the flare gas. Below is the list of allowable values. [98.256(q)]</p> <p>Method 18 at 40 CFR part 60, appendix A-6 ASTM D1945-03 ASTM D1946-90 (Reapproved 2006) GPA 2261-00 UOP539-97 ASTM D2503-92 (Reapproved 2007) Chromatographic analysis: manufacturer's instructions Other (specify)</p>
OtherAnnualAverageCarbonContentMethod	<p>Conditionally Required: Specify the method used to determine the annual average carbon content of the flare gas if not listed above.</p>

XML Excerpt 7 Example for Equation Y-1a

```

<ghg:Y1aEquationDetails>
  <ghg:MeasurementPeriod>Daily</ghg:MeasurementPeriod>
  <ghg:AnnualVolumeofFlareGas volUOM="scf">
    <ghg:MeasureValue>2332.2342</ghg:MeasureValue>
    <ghg:NumberOfTimesSubstituted>2</ghg:NumberOfTimesSubstituted>
  </ghg:AnnualVolumeofFlareGas>
  <ghg:AnnualVolumeofFlareGasMethod>Method 123</ghg:AnnualVolumeofFlareGasMethod>
  <ghg:AnnualAverageMolecularWeight molewtUOM="kg/kg-mole">
    <ghg:MeasureValue>235.45678</ghg:MeasureValue>
    <ghg:NumberOfTimesSubstituted>5</ghg:NumberOfTimesSubstituted>
  </ghg:AnnualAverageMolecularWeight>
  <ghg:AnnualAverageMolecularWeightMethod>GPA 2261-00</ghg:AnnualAverageMolecularWeightMethod>
  <ghg:AnnualAverageCarbonContent carboncontentUOM="decimal fraction; kg carbon/kg flare gas">
    <ghg:MeasureValue>.21</ghg:MeasureValue>
    <ghg:NumberOfTimesSubstituted>7</ghg:NumberOfTimesSubstituted>
  </ghg:AnnualAverageCarbonContent>
  <ghg:AnnualAverageCarbonContentMethod>ASTM D1945-03</ghg:AnnualAverageCarbonContentMethod>
</ghg:Y1aEquationDetails>

```

Note: The XML example above is presented here to demonstrate the concept of reporting the details for Equation Y-1a.

2.2 Equation Y-1b Details, Gas Composition Monitored

Conditionally Required: This topic provides a step-by-step description of how to report details about Equation Y-1b. This method is used for calculating CO₂ emissions if you monitor gas composition and measure both the mole percentage of CO₂ concentration and the number of carbon compounds, other than CO₂, in the flare gas stream.

Figure 13
Equation Y-1b Details Schema Diagram

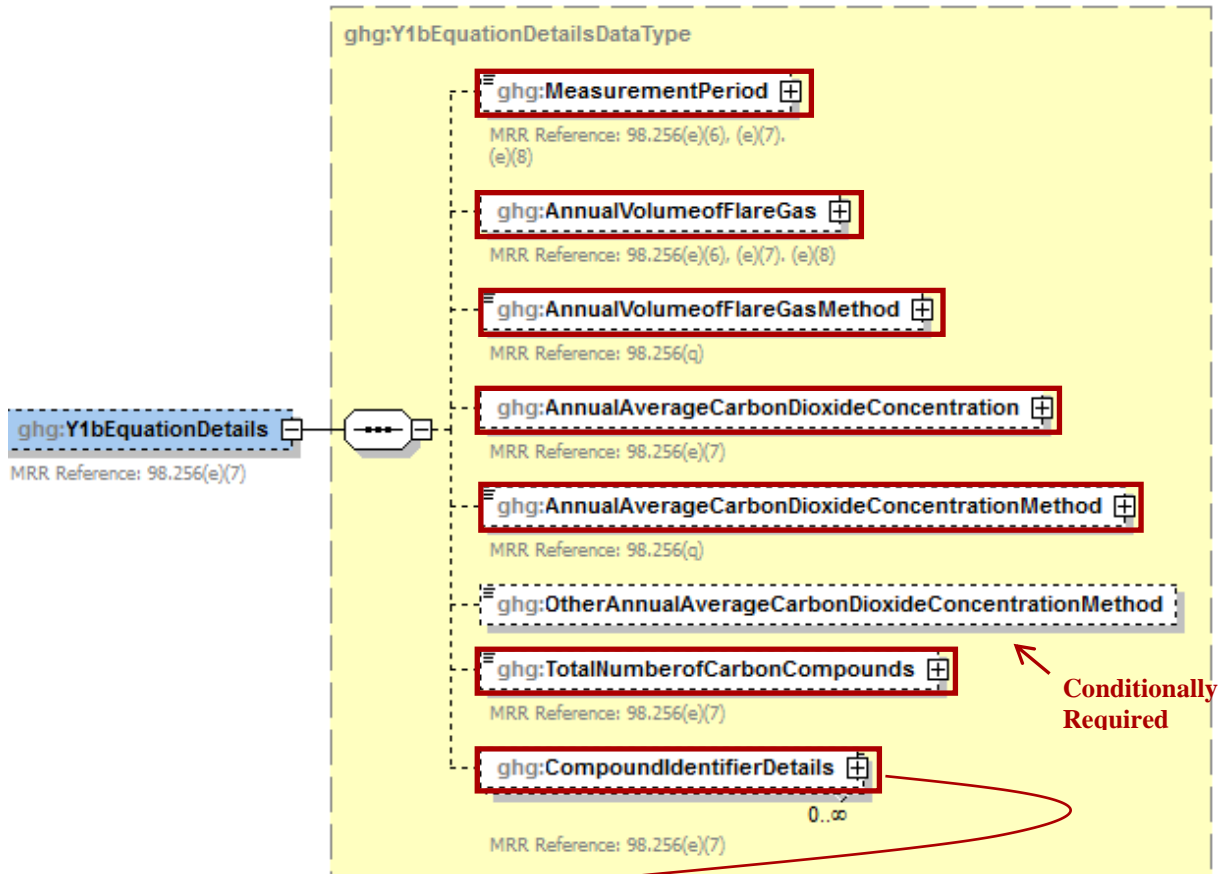
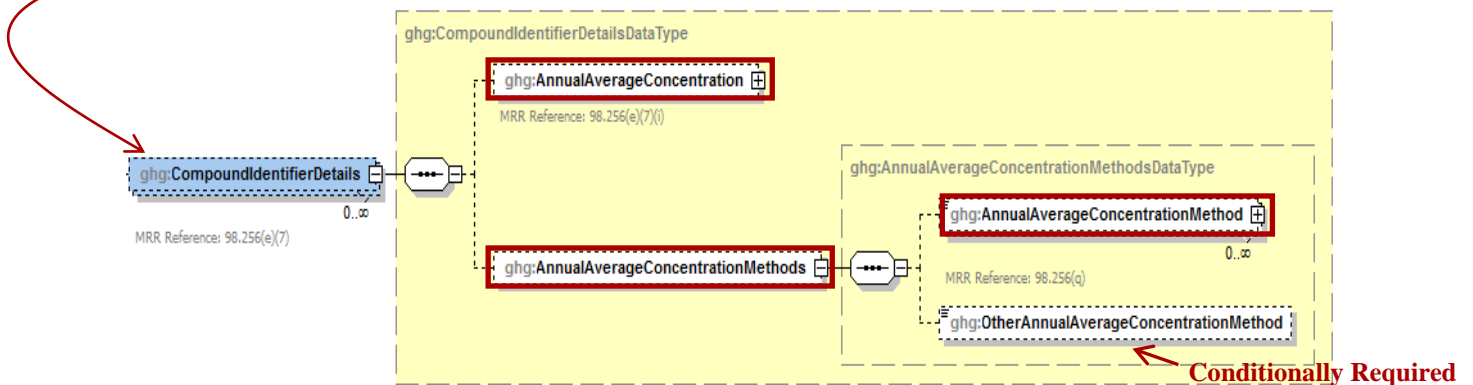

Figure 14
Compound Identifier Details Schema Diagram



Note: Data elements boxed in red are required. Please see page 4 of this document for more information on conditionally required elements.

To calculate the annual CO₂ emissions from flare units, you can download the Y-1b spreadsheet from the e-GGRT help site or use the following information:

$$CO_2 = \sum_{p=1}^n \left[\left(\text{Flare}_p \times \frac{44}{MVC} \times 0.001 \times \left(\frac{\%CO_2_p}{100\%} + \sum_{x=1}^y \left\{ 0.98 \times \frac{\%C_x_p}{100\%} \times CMN_x \right\} \right) \right) \right]$$

Where:

CO ₂	=	Annual CO ₂ emissions for a specific fuel type (metric tons/year).
N	=	Number of measurement periods. The minimum value for n is 52 (for weekly measurements); the maximum value for n is 366 (for daily measurements during a leap year).
p	=	Measurement period index.
(Flare) _p	=	Volume of flare gas combusted during measurement period (standard cubic feet per period, scf/period). If a mass flow meter is used, you must determine the average molecular weight of the flare gas during the measurement period and convert the mass flow to a volumetric flow.
44	=	Molecular weight of CO ₂ (kg/kg-mole).
MVC	=	Molar volume conversion factor (849.5 scf/kg-mole at 68°F and 14.7 psia or 836.6 scf/kg-mole at 60°F and 14.7 psia).
0.001	=	Unit conversion factor (metric tons per kilogram, mt/kg).
(%CO ₂) _p	=	Mole percent CO ₂ concentration in the flare gas stream during the measurement period (mole percent = percent by volume).
y	=	Number of carbon-containing compounds other than CO ₂ in the flare gas stream.
X	=	Index for carbon-containing compounds other than CO ₂ .
0.98	=	Assumed combustion efficiency of a flare (mole CO ₂ per mole carbon).
(%C _x) _p	=	Mole percent concentration of compound "x" in the flare gas stream during the measurement period (mole percent = percent by volume)
CMN _x	=	Carbon mole number of compound "x" in the flare gas stream (mole carbon atoms per mole compound). E.g., CMN for ethane (C ₂ H ₆) is 2; CMN for propane (C ₃ H ₈) is 3.

You must report the following data if you used Equation Y-1b to calculate CO₂ emissions:

- An indication of whether daily or weekly measurement periods are used [98.256(e)(7)]
- The annual volume of flare gas combusted (in scf) [98.256(e)(7)]
- The number of days missing data procedures were used to determine the annual volume of flare gas combusted
- The specific consensus-based standard method number or description of the procedure specified by the flow meter manufacturer [98.256(q)]
- The annual average CO₂ concentration (percent by volume or mole) [98.256(e)(7)]
- The number of days missing data procedures were used to determine the annual average CO₂ concentration
- The method used to measure the annual average CO₂ concentration [98.256(q)]
- The total number of carbon containing compounds other than CO₂ that are in the flare gas stream [98.256(e)(7)]

For each carbon containing compound other than CO₂ in the flare gas stream identified by the facility, and for each flare using the Equation Y-1b, report the following:

- The annual average concentration of the compound (percent by volume or mole) [98.256(e)(7)(i)]
- The number of days missing data procedures were used to determine annual average concentration of the compound
- The method used to measure the annual average concentration of the compound [98.256(q)]

Table 12
Y1bEquationDetails Data Element Definitions

Data Element Name	Description
Y1bEquationDetails	Parent Element (Conditionally Required)
MeasurementPeriod	An indication of whether daily or weekly measurement periods are used. [98.256(e)(7)] Below is a list of the allowable values: Daily Weekly
AnnualVolumeofFlareGas	The annual volume of flare gas combusted. [98.256(e)(7)] Report the value in the child data element MeasureValue . Set the units of measure to “scf” in the attribute volUOM . Also report the number of days that missing data procedures were used in measuring the annual volume of flare gas combusted in the child data element NumberofTimesSubstituted . [98.3(c)(8)]
AnnualVolumeofFlareGasMethod	The specific consensus-based standard method or description of the procedure specified by the flow meter manufacturer. [98.256(q)]
AnnualAverageCarbonDioxideConcentration	The annual average CO ₂ concentration in the flare gas stream. [98.256(e)(7)] Report the value in the child data element MeasureValue . Set the units of measure to “percent by volume or mole” in the attribute concentrationUOM . Also report the number of days that missing data procedures were used in measuring the annual average CO ₂ concentration in the flare gas stream in the child data element NumberofTimesSubstituted . [98.3(c)(8)]
AnnualAverageCarbonDioxideConcentration Method	The method used to determine the annual average CO ₂ concentration in the flare gas. [98.256(q)] Below is the list of allowable values. Method 18 at 40 CFR part 60, appendix A-6 ASTM D1945-03 ASTM D1946-90 (Reapproved 2006) GPA 2261-00 UOP539-97 ASTM D2503-92 (Reapproved 2007) Chromatographic analysis: manufacturer’s instructions Other (specify)
OtherAnnualAverageCarbonDioxideConcentration Method	Conditionally Required: Specify the method used to determine the annual average CO ₂ concentration in the flare gas if not listed above.
TotalNumberofCarbonCompounds	The total number of carbon containing compounds other than CO ₂ in the flare gas stream (integer). [98.256(e)(7)]
CompoundIdentifierDetails	Parent Element: A collection of data elements containing details about the carbon containing compounds, other than CO ₂ in the flare gas stream.

Data Element Name	Description
AnnualAverageConcentration	The annual average concentration of the compound for each carbon containing compound, other than CO ₂ , in the flare gas stream. [98.256(e)(7)(i)] Report the value in the child data element MeasureValue . Set the units of measure to “percent by volume or mole” in the attribute concentrationUOM . Also report the number of days that missing data procedures were used in measuring the annual average concentration of the compound in the child data element NumberOfTimesSubstituted . [98.3(c)(8)]
AnnualAverageConcentrationMethods	Parent Element
AnnualAverageConcentrationMethod	The method used to determine the annual average concentration of the carbon containing compound in the flare gas stream. [98.256(q)] Below is the list of allowable values. Method 18 at 40 CFR part 60, appendix A-6 ASTM D1945-03 ASTM D1946-90 (Reapproved 2006) GPA 2261-00 UOP539-97 ASTM D2503-92 (Reapproved 2007) Chromatographic analysis: manufacturer’s instructions Other (specify)
OtherAnnualAverageConcentrationMethod	Conditionally Required: Specify the method used to determine the annual average concentration of the carbon containing compound in the flare gas stream if not listed above.

XML Excerpt 8 Example for Equation Y-1b

```

<ghg:Y1bEquationDetails>
  <ghg:MeasurementPeriod>Weekly</ghg:MeasurementPeriod>
  <ghg:AnnualVolumeofFlareGas volUOM="scf">
    <ghg:MeasureValue>2332.23568</ghg:MeasureValue>
    <ghg:NumberOfTimesSubstituted>2</ghg:NumberOfTimesSubstituted>
  </ghg:AnnualVolumeofFlareGas>
  <ghg:AnnualVolumeofFlareGasMethod>Method 123</ghg:AnnualVolumeofFlareGasMethod>
  <ghg:AnnualAverageCarbonDioxideConcentration concentrationUOM="percent by volume or mole">
    <ghg:MeasureValue>23</ghg:MeasureValue>
    <ghg:NumberOfTimesSubstituted>5</ghg:NumberOfTimesSubstituted>
  </ghg:AnnualAverageCarbonDioxideConcentration>
  <ghg:AnnualAverageCarbonDioxideConcentrationMethod>UOP539-97</ghg:AnnualAverageCarbonDioxideConcentrationMethod>
  <ghg:TotalNumberOfCarbonCompounds>1</ghg:TotalNumberOfCarbonCompounds>
  <ghg:CompoundIdentifierDetails>
    <ghg:AnnualAverageConcentration concentrationUOM="percent by volume or mole">
      <ghg:MeasureValue>99</ghg:MeasureValue>
      <ghg:NumberOfTimesSubstituted>0</ghg:NumberOfTimesSubstituted>
    </ghg:AnnualAverageConcentration>
    <ghg:AnnualAverageConcentrationMethods>
      <ghg:AnnualAverageConcentrationMethod>UOP539-97</ghg:AnnualAverageConcentrationMethod>
    </ghg:AnnualAverageConcentrationMethods>
  </ghg:CompoundIdentifierDetails>
</ghg:Y1bEquationDetails>

```

Note: The XML example above is presented here to demonstrate the concept of reporting the details for Equation Y-1b.

2.3 Equation Y-2 Details, Heat Content Monitored

Conditionally Required: This topic provides a step-by-step description of how to report details about Equation Y-2. This method is used for calculating CO₂ emissions if you monitor heat content but do not monitor gas composition.

Figure 15
Equation Y-2 Details Schema Diagram

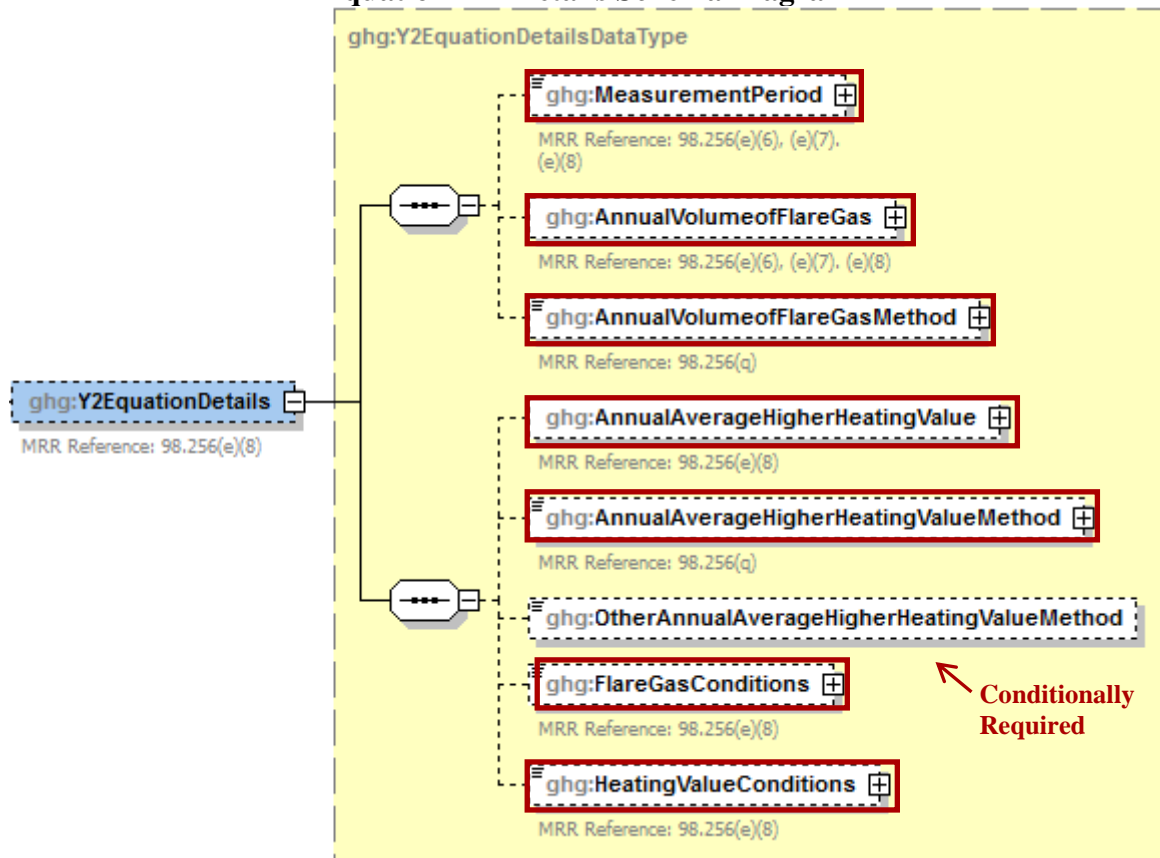

Note: Data elements boxed in red are required. Please see page 4 of this document for more information on conditionally required elements.

To calculate the annual CO₂ emissions from flare units, you can download the Y-1b spreadsheet from the e-GGRT help site or use the following information:

$$CO_2 = 0.98 \times 0.001 \times \sum_{p=1}^n \left[\text{Flare}_p \times \text{HHV}_p \times \text{EmF} \right]$$

Where:

- CO₂ = Annual CO₂ emissions for a specific fuel type (metric tons/year).
- 0.98 = Assumed combustion efficiency of a flare.
- 0.001 = Unit conversion factor (metric tons per kilogram, mt/kg).
- n = Number of measurement periods. The minimum value for n is 52 (for weekly measurements); the maximum value for n is 366 (for daily measurements during a leap year).
- p = Measurement period index.
- (Flare)_p = Volume of flare gas combusted during measurement period (million (MM) scf/period). If a mass flow meter is used, you must also measure molecular weight and convert the mass flow to a volumetric flow as follows:
Flare[MMscf] = 0.000001 × Flare[kg] × MVC/(MW)_p, where MVC is the

	molar volume conversion factor [849.5 scf/kg-mole at 68 °F and 14.7 psia or 836.6 scf/kg-mole at 60 °F and 14.7 psia depending on the standard conditions used when determining (HHV) _p] and (MW) _p is the average molecular weight of the flare gas combusted during measurement period (kg/kg-mole).
(HHV) _p =	Higher heating value for the flare gas combusted during measurement period (British thermal units per scf, Btu/scf = MMBtu/MMscf). If measurements are taken more frequently than daily, use the arithmetic average of measurement values within the day to calculate a daily average.
EmF =	Default CO ₂ emission factor of 60 kilograms CO ₂ /MMBtu (HHV basis).

You must report the following data if you used Equation Y-2 to calculate CO₂ emissions:

- An indication of whether daily or weekly measurement periods are used [98.256(e)(8)]
- The annual volume of flare gas combusted (MMscf) [98.256(e)(8)]
- The number of days missing data procedures were used to determine the annual volume of flare gas combusted
- The specific consensus-based standard method number or describe the procedure specified by the flow meter manufacturer [98.256(q)]
- The annual average higher heating value of the flare gas (MMBtu/MMscf) [98.256(e)(8)]
- The number of days missing data procedures were used to determine the annual average higher heating value of the flare gas
- The method used to measure annual average higher heating value of the flare gas [98.256(q)]
- An indication of whether the annual volume of flare gas combusted was determined using standard conditions of 68 °F and 14.7 psia or 60 °F and 14.7 psia [98.256(e)(8)]
- An indication of whether the annual average higher heating value of the flare gas was determined using standard conditions of 68 °F and 14.7 psia or 60 °F and 14.7 psia [98.256(e)(8)]

Table 13
Y2EquationDetails Data Element Definitions

Data Element Name	Description
Y2EquationDetails	Parent Element (Conditionally Required)
MeasurementPeriod	An indication of whether daily or weekly measurement periods are used. [98.256(e)(8)] Below is a list of the allowable values. Daily Weekly
AnnualVolumeofFlareGas	The annual volume of flare gas combusted. [98.256(e)(8)] Report the value in the child data element MeasureValue . Set the units of measure to “MMscf” in the attribute volUOM . Also report the number of days that missing data procedures were used in measuring the annual volume of flare gas combusted in the child data element NumberOfTimesSubstituted . [98.3(c)(8)]
AnnualVolumeofFlareGasMethod	The specific consensus-based standard method or description of the procedure specified by the flow meter manufacturer. [98.256(q)]

Data Element Name	Description
AnnualAverageHigherHeatingValue	The annual average higher heating value of the flare gas combusted. [98.256(e)(8)] Report the value in the child data element MeasureValue . Set the units of measure to “MMBtu/MMscf” in the attribute heatUOM . Also report the number of days that missing data procedures were used in the child data element NumberOfTimesSubstituted . [98.3(c)(8)]
AnnualAverageHigherHeatingValueMethod	The method used to determine the annual average higher heating value of the flare gas. Below is a list of allowable values. [98.256(q)] ASTM D4809-06 ASTM D240-02 (Reapproved 2007) ASTM D1826-94 (Reapproved 2003) ASTM D3588-98 (Reapproved 2003) ASTM D4891-89 (Reapproved 2006) Chromatographic analysis: manufacturer’s instructions Other (specify)
OtherAnnualAverageHigherHeatingValueMethod	Conditionally Required: Specify the method used to determine the annual average higher heating value of the flare gas if not listed above.
FlareGasConditions	The conditions on which the annual volume of flare gas combusted was determined. [98.256(e)(8)] Below is the list of allowable values. 60 degrees F and 14.7 psia 68 degrees F and 14.7 psia
HeatingValueConditions	The conditions on which the annual average higher heating value of the flare gas stream was determined. [98.256(e)(8)] Below is the list of allowable values. 60 degrees F and 14.7 psia 68 degrees F and 14.7 psia

**XML Excerpt 9
Example for Equation Y-2**

```

<ghg:Y2EquationDetails>
  <ghg:MeasurementPeriod>Daily</ghg:MeasurementPeriod>
  <ghg:AnnualVolumeofFlareGas volUOM="MMscf">
    <ghg:MeasureValue>2332.2314</ghg:MeasureValue>
    <ghg:NumberOfTimesSubstituted>2</ghg:NumberOfTimesSubstituted>
  </ghg:AnnualVolumeofFlareGas>
  <ghg:AnnualVolumeofFlareGasMethod>specific consensus-based method 123</ghg:AnnualVolumeofFlareGasMethod>
  <ghg:AnnualAverageHigherHeatingValue heatUOM="MMBtu/MMscf">
    <ghg:MeasureValue>25</ghg:MeasureValue>
    <ghg:NumberOfTimesSubstituted>24</ghg:NumberOfTimesSubstituted>
  </ghg:AnnualAverageHigherHeatingValue>
  <ghg:AnnualAverageHigherHeatingValueMethod>ASTM D4809-06</ghg:AnnualAverageHigherHeatingValueMethod>
  <ghg:FlareGasConditions >68 degrees F and 14.7 psia</ghg:FlareGasConditions >
  <ghg:HeatingValueConditions >60 degrees F and 14.7 psia</ghg:HeatingValueConditions >
</ghg:Y2EquationDetails>
    
```

Note: The XML example above is presented here to demonstrate the concept of reporting the details for Equation Y-2.

2.4 Equation Y-3 Details, Start-up, Shutdown, Malfunction

Conditionally Required: This topic provides a step-by-step description of how to report details about Equation Y-3. This method is used for calculating CO₂ emissions if you do not monitor gas composition nor measure the higher heating value or carbon content of the flare gas at least weekly.

Figure 16
Equation Y-3 Summary and Result Schema Diagram

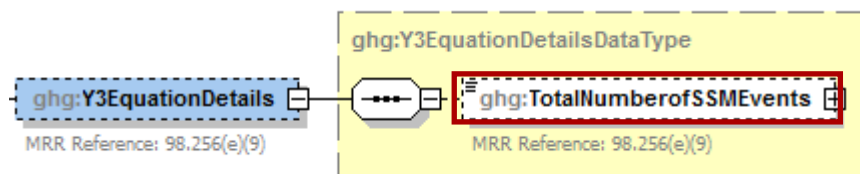

Note: Data elements boxed in red are required.

$$CO_2 = 0.98 \times 0.001 \times \left(Flare_{Norm} \times HHV \times EmF + \sum_{p=1}^n \left[\frac{44}{12} \times \left(Flare_{SSM} \right)_p \times \frac{(MW)_p}{MVC} \times (CC)_p \right] \right)$$

Where:

CO ₂	=	Annual CO ₂ emissions for a specific fuel type (metric tons/year).
0.98	=	Assumed combustion efficiency of a flare.
0.001	=	Unit conversion factor (metric tons per kilogram, mt/kg).
FlareNorm	=	Annual volume of flare gas combusted during normal operations from company records, (million (MM) standard cubic feet per year, MMscf/year).
HHV	=	Higher heating value for fuel gas or flare gas from company records (British thermal units per scf, Btu/scf = MMBtu/MMscf).
EmF	=	Default CO ₂ emission factor for flare gas of 60 kilograms CO ₂ /MMBtu (HHV basis).
n	=	Number of start-up, shutdown and malfunction events during the reporting year exceeding 500,000 scf/day.
P	=	Start-up, shutdown and malfunction event index.
44	=	Molecular weight of CO ₂ (kg/kg-mole).
12	=	Atomic weight of C (kg/kg-mole).
(FlareSSM) _p	=	Volume of flare gas combusted during indexed start-up, shutdown, or malfunction event from engineering calculations, (scf/event).
(MW) _p	=	Average molecular weight of the flare gas, from the analysis results or engineering calculations for the event (kg/kg-mole).
MVC	=	Molar volume conversion factor (849.5 scf/kg-mole at 68 °F and 14.7 psia or 836.6 scf/kg-mole at 60 °F and 14.7 psia).
(CC) _p	=	Average carbon content of the flare gas, from analysis results or engineering calculations for the event (kg C per kg flare gas).

For each flare using the Equation Y-3 calculation method, identify the total number of start-up, shutdown, or malfunction (SSM) events exceeding 500,000 scf/day.

Table 14
Y3EquationDetails Data Element Definitions

Data Element Name	Description
Y3EquationDetails	Parent Element (Conditionally Required)
TotalNumberofSSMEvents	The total number of start-up, shutdown, or malfunction (SSM) events exceeding 500,000 scf/day (integer). [98.256(e)(9)]

XML Excerpt 10
Example for Equation Y-3

```

<ghg:Y3EquationDetails>
  <ghg:TotalNumberofSSMEvents>15</ghg:TotalNumberofSSMEvents>
</ghg:Y3EquationDetails>
    
```

Note: The XML example above is presented here to demonstrate the concept of reporting the details for Equation Y-3.

 ***Does the facility have any catalytic cracking, fluid coking or catalytic reforming unit information to report?***

 If the facility has any catalytic cracking, fluid coking and/or catalytic reforming units, see [Section 3.0](#) for instructions on how to report for the parent element “CrackingCokingReformingDetails.”

 If the facility has no catalytic cracking, fluid coking and/or catalytic reforming units, see [Section 4.1](#) for required subpart-level reporting for the parent element “SulfurRecoveryDetails.”

3.0 Catalytic Cracking, Fluid Coking and Catalytic Reforming Unit Information

Conditionally Required Unit-Level Data

This topic provides a step-by-step description of how to report Catalytic Cracking, Fluid Coking or Catalytic Reforming unit information.

3.1 Cracking Coking Unit Details

You must report CO₂, CH₄ and N₂O coke burn-off emissions from each catalytic cracking unit, fluid coking unit and catalytic reforming unit which is not monitored by a CEMS under this Subpart. For units monitored by a CEMS, CH₄ and N₂O emissions must be reported, however CO₂ emissions must be reported for the corresponding CEMS monitoring location (CML).

Figure 17
Cracking Coking Reforming Unit Details Schema Diagram

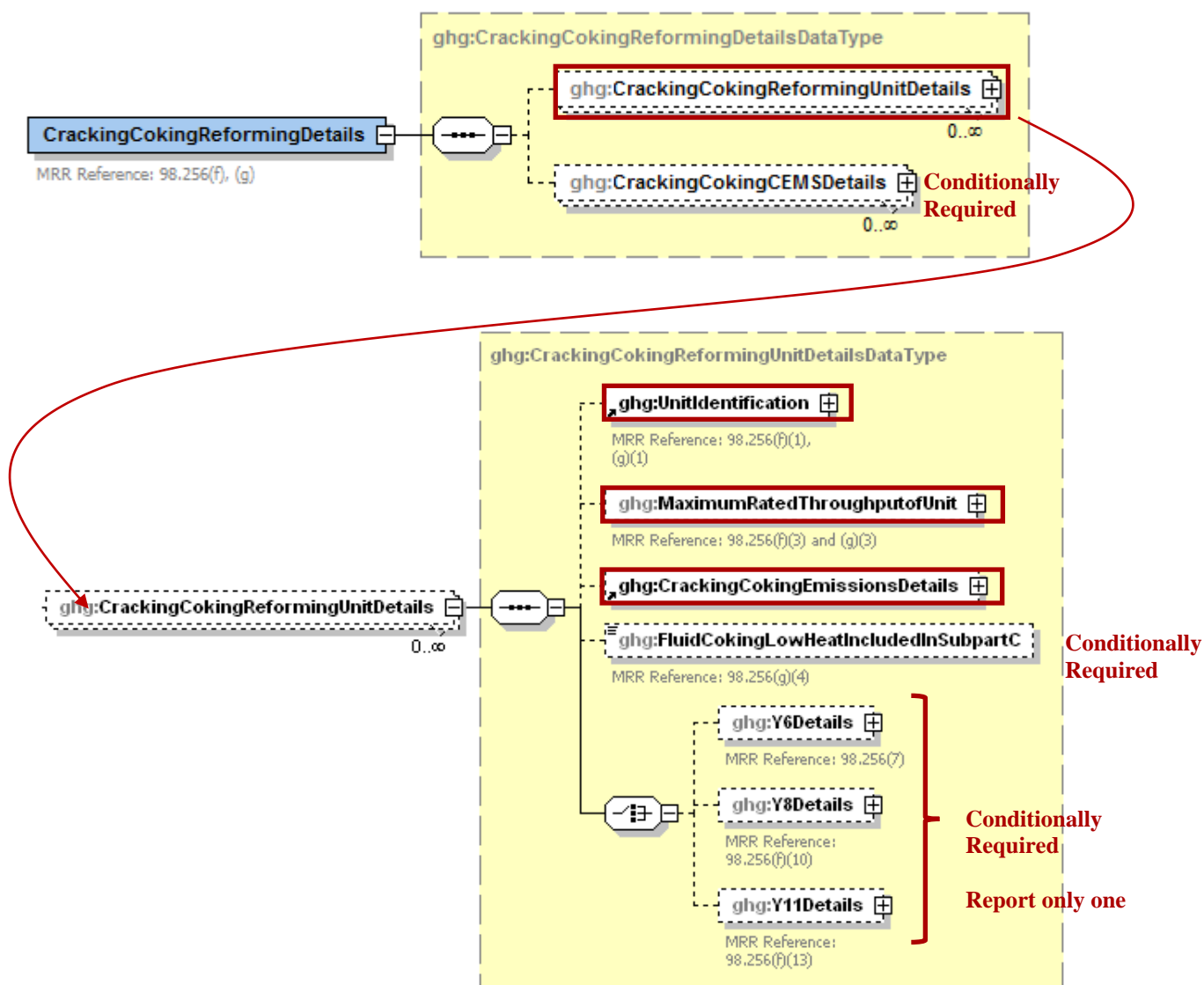

Note: Data elements boxed in red are required. Please see page 4 of this document for more information on conditionally required elements.

You are required to report the following data about your Catalytic Cracking, Fluid Coking, or Catalytic Reforming unit:

- A unique name or identifier, plus an optional description for this unit (see also [About Unique Unit Names](#)).
- The type of unit.
 - Fluid Catalytic Cracking Unit
 - Thermal Catalytic Cracking Unit
 - Traditional Fluid Coking Unit
 - Catalytic Reforming Unit
 - Fluid Coking Unit with Flexicoking Design
- The maximum rated throughput of the fluid catalytic cracking unit (bbl per stream day).

Table 15
Cracking Coking Reforming Unit Data Element Definitions

Data Element Name	Description
CrackingCokingReformingDetails	Parent Element (Conditionally Required)
CrackingCokingReformingUnitDetails	Parent Element: A collection of data elements containing details about emissions from each catalytic cracking unit, traditional fluid coking unit, and catalytic reforming unit.
UnitIdentification	A collection of data elements containing the identity of each cracking, coking or reforming unit. Report a unique unit name (ID) in the child data element UnitName , an optional brief description in the child data element UnitDescription and the type of unit in the child data element UnitType . [98.256(f)(1) & (2), (g)(1) & (2)] Report one of the following unit types: Fluid Catalytic Cracking Unit Thermal Catalytic Cracking Unit Traditional Fluid Coking Unit Catalytic Reforming Unit Fluid Coking Unit with Flexicoking Design
MaximumRatedThroughputofUnit	The maximum rated throughput of the unit. Report the value in the child data element MeasureValue . Set the units of measure to "bbls/streamday" in the attribute rateUOM . [98.256(f)(3) & (g)(3)]

XML Excerpt 11 Example for Cracking Coking Reforming Unit Details

```

<ghg:CrackingCokingReformingDetails>
  <ghg:CrackingCokingReformingUnitDetails>
    <ghg:UnitIdentification>
      <ghg:UnitName>008</ghg:UnitName>
      <ghg:UnitType>Fluid Catalytic Cracking Unit</ghg:UnitType>
    </ghg:UnitIdentification>
    <ghg:MaximumRatedThroughputofUnit rateUOM="bbls/streamday">
      <ghg:MeasureValue>1000</ghg:MeasureValue>
    </ghg:MaximumRatedThroughputofUnit>
  </ghg:CrackingCokingReformingUnitDetails>
</ghg:CrackingCokingReformingDetails>
    
```

Note: The XML example above is presented here to demonstrate the concept of reporting details for catalytic cracking, fluid coking or catalytic reforming units.

Figure 18 Cracking Coking Emissions Details Schema Diagram

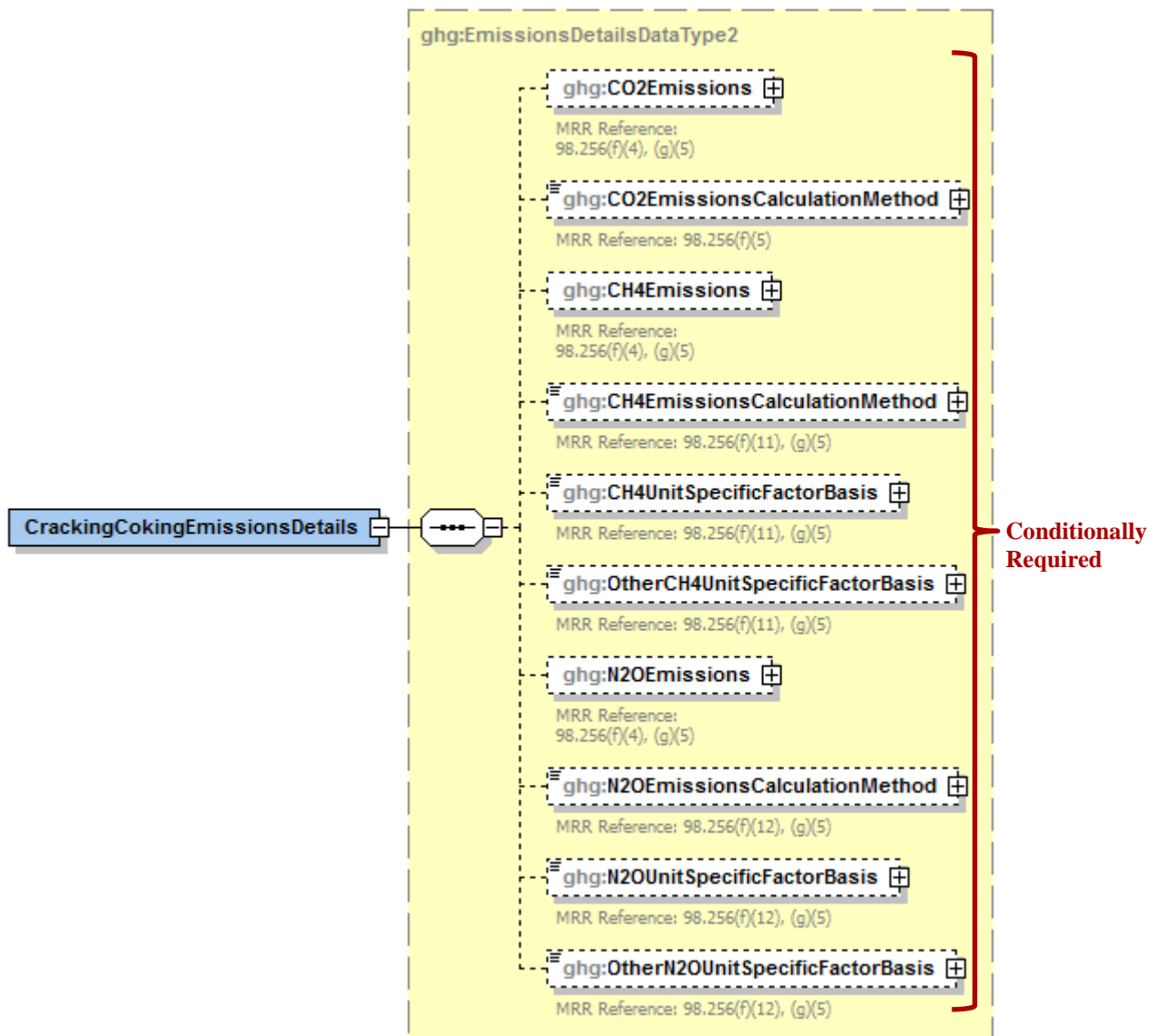

Note: Data elements boxed in red are required. Please see page 4 of this document for more information on conditionally required elements.

Subpart Y collects the following data about your catalytic cracking, or fluid coking and catalytic reforming unit emissions:

- **Conditionally Required:** The calculated CO₂ annual emissions for each non-CEMS unit, expressed in metric tons. To report annual CO₂ emissions, follow the instructions that correspond to the calculation method reported. (See the applicable section in this document: Equation Y-1a Details, Equation Y-1b Details, Equation Y-2 Details, or Equation Y-3 Details). **Note:** This does not apply to Fluid Coking Units with flexicoking design having GHG emissions accounted for in Subpart C.
- **Conditionally Required:** Method used to calculate the CO₂ emissions for each unit. **Note:** This does not apply to Fluid Coking Units with flexicoking design having GHG emissions accounted for in Subpart C.
 - 98.253(c)(1) - CEMS
 - 98.253(c)(2) - Equation Y-6 and continuous monitor for flow (but not meeting the CEMS monitoring requirements of 98.253(c)(1); e.g., not meeting the full CEMS quality assurance requirements)
 - 98.253(c)(2) - Equation Y-6 and Y-7a
 - 98.253(c)(2) - Equation Y-6 and Y-7b
 - 98.253(c)(3) - Equation Y-8 **Note:** This option applies only to Catalytic Cracking or Coking units; applicable only for catalytic cracking units and fluid coking units with rated capacities of 10,000 barrels per stream day (bbls/streamday) or less that do not use a continuous CO₂ CEMS for the final exhaust stack).
 - 98.253(e)(3) - Equation Y-11 **Note:** This option applies only to Catalytic Reforming units.
- **Conditionally Required:** The calculated CH₄ and N₂O annual emissions for each unit, expressed in metric tons of each GHG emitted. **Note:** This does not apply to Fluid Coking Units with flexicoking design having GHG emissions accounted for in Subpart C.
- **Conditionally Required:** Method used to calculate CH₄ emissions. **Note:** This does not apply to Fluid Coking Units with flexicoking design having GHG emissions accounted for in Subpart C.
 - Unit-specific measurement data
 - Unit-specific emissions factor based on a source test of the unit
 - Equation Y-9 with a default emission factor
- **Conditionally Required:** Method used to calculate N₂O emissions. **Note:** This does not apply to Fluid Coking Units with flexicoking design having GHG emissions accounted for in Subpart C.
 - Unit-specific measurement data
 - Unit-specific emissions factor based on a source test of the unit
 - Equation Y-10 with a default emission factor
- **Conditionally Required:** The basis for each unit-specific emissions factor based on a source test of the unit that is used to calculate CH₄ and N₂O emissions, if reported.
 - Weekly or more frequent measurements
 - Periodic (less frequent than weekly) measurements
 - Average of multiple source tests
 - One-time source test
 - Other (specify)

Conditionally Required: For each unit of the type “Fluid Coking Unit with Flexicoking Design”, indicate whether the GHG emissions from the low heat value gas are accounted for in Subpart C instead of 98.253(c).

Table 16
Cracking Coking Reforming Emissions Data Element Definitions

Data Element Name	Description
CrackingCokingEmissionsDetails	Parent Element
CO2Emissions	Conditionally Required: Calculated CO ₂ annual emissions for each non-CEMS unit. [98.256(f)(4)] Report the value in the child data element CalculatedValue . Set the units of measure to “Metric Tons” in the attribute massUOM . Note: This does not apply to Fluid Coking Units with flexicoking design having GHG emissions accounted for in Subpart C.
CO2EmissionsCalculationMethod	Conditionally Required: The method used to calculate the CO ₂ emissions for each unit (e.g., reference section and equation number). [98.256(f)(5)] Note: This does not apply to Fluid Coking Units with flexicoking design having GHG emissions accounted for in Subpart C. Also, Equation Y-11 below only applies to catalytic reforming units. Below is the list of allowable values. CEMS - 98.253(c)(1) Equation Y-6 and Y-7a - 98.253(c)(2) Equation Y-6 and Y-7b - 98.253(c)(2) Equation Y-6 and continuous monitor for flow - 98.253(c)(2) Equation Y-8 - 98.253(c)(3) Equation Y-11 - 98.253(e)(3)
CH4Emissions	Conditionally Required: Calculated CH ₄ annual emissions for each unit. Report the value in the child data element CalculatedValue . Set the units of measure to “Metric Tons” in the attribute massUOM . Note: This does not apply to Fluid Coking Units with flexicoking design having GHG emissions accounted for in Subpart C.
CH4EmissionsCalculationMethod	Conditionally Required: The method used to calculate the CH ₄ emissions for each unit (e.g., reference section and equation number). [98.256(f)(11) and 98.256(g)(5)] Note: This does not apply to Fluid Coking Units with flexicoking design having GHG emissions accounted for in Subpart C. Below is the list of allowable values. Unit-specific measurement data Unit-specific emissions factor based on a source test of the unit Equation Y-9 with a default emission factor
CH4UnitSpecificFactorBasis	Conditionally Required: The basis for the unit-specific emission factor used to determine CH ₄ annual emissions if the emission factor was based on a source test of the unit. [98.256(f)(11) and 98.256(g)(5)] Below is the list of allowable values. Weekly or more frequent measurements Periodic (less frequent than weekly) measurements Average of multiple source tests One-time source test Other (specify)

Data Element Name	Description
OtherCH4UnitSpecificFactorBasis	Conditionally Required: The basis for the unit-specific emission factor used to determine CH ₄ emissions if not referenced in the list of allowable basis values.
N2OEmissions	Conditionally Required: Annual N ₂ O emissions for each unit. [98.256(f)(4) and 98.256(g)(5)] Report the value in the child data element CalculatedValue . Set the units of measure to “Metric Tons” in the attribute massUOM . Note: This does not apply to Fluid Coking Units with flexicoking design having GHG emissions accounted for in Subpart C.
N2OEmissionsCalculationMethod	Conditionally Required: The method used to calculate the N ₂ O emissions for each unit (e.g., reference section and equation number). [98.256(f)(12) and 98.256(g)(5)] Note: This does not apply to Fluid Coking Units with flexicoking design having GHG emissions accounted for in Subpart C. Below is the list of allowable values. Unit-specific measurement data Unit-specific emissions factor based on a source test of the unit Equation Y-10 with a default emission factor
N2OUnitSpecificFactorBasis	Conditionally Required: The basis for the unit-specific emission factor used to determine N ₂ O annual emissions if the emission factor was based on a source test of the unit. [98.256(f)(12) and 98.256(g)(5)] Below is the list of allowable values. Weekly or more frequent measurements Periodic (less frequent than weekly) measurements Average of multiple source tests One-time source test Other (specify)
OtherN2OUnitSpecificFactorBasis	Conditionally Required: The basis for the unit-specific emission factor used to determine N ₂ O emissions if not referenced in the list of allowable basis values.
FluidCokingLowHeatIncludedInSubpartC	Conditionally Required: For each unit of the type “Fluid Coking Unit with Flexicoking Design”, indicate (Y/N) whether the GHG emissions from the low heat value gas are accounted for in Subpart C instead of 98.253(c). [98.256(g)(4)]

XML Excerpt 12 Example for Cracking Coking Emissions

```

<ghg:CrackingCokingEmissionsDetails>
  <ghg:CO2Emissions massUOM="Metric Tons">
    <ghg:CalculatedValue>4322.6</ghg:CalculatedValue>
  </ghg:CO2Emissions>
  <ghg:CO2EmissionsCalculationMethod> Equation Y-6 and Y-7a - 98.253(c)(2)</ghg:CO2EmissionsCalculationMethod>
  <ghg:CH4Emissions massUOM="Metric Tons">
    <ghg:CalculatedValue>2342.88</ghg:CalculatedValue>
  </ghg:CH4Emissions>
  <ghg:CH4EmissionsCalculationMethod>Equation Y-9 with a default emission factor</ghg:CH4EmissionsCalculationMethod>
  <ghg:N2OEmissions massUOM="Metric Tons">
    <ghg:CalculatedValue>2221.234</ghg:CalculatedValue>
  </ghg:N2OEmissions>
  <ghg:N2OEmissionsCalculationMethod>Unit-specific emission factor based on a source test of the
unit</ghg:N2OEmissionsCalculationMethod>
  <ghg:N2OUnitSpecificFactorBasis>Other (specify)</ghg:N2OUnitSpecificFactorBasis>
  <ghg:OtherN2OUnitSpecificFactorBasis>Bi-weekly</ghg:OtherN2OUnitSpecificFactorBasis>
</ghg:CrackingCokingEmissionsDetails>

```

Note: The XML example above is presented here to demonstrate the concept of reporting CO₂, CH₄ and N₂O emissions for a fluid coking unit with flexicoking design.



Which equation did you use to calculate CO₂ emissions for the unit?



If you used Equation Y-6, see [Section 3.1.1](#) for instructions on how to report for the parent element “Y6Details.”



If you used Equation Y-8, see [Section 3.1.2](#) for instructions on how to report for the parent element “Y8Details.”



If you used Equation Y-11, see [Section 3.1.3](#) for instructions on how to report for the parent element “Y11Details.”

3.1.1 Equation Y-6 Details

This topic provides a step-by-step description of how to report details about the method used to calculate CO₂ emissions from catalytic cracking units and fluid coking units with rated capacities greater than 10,000 barrels per stream day that do not use a continuous CO₂ CEMS for the final exhaust stack. This topic also applies to reporting CO₂ emissions from catalytic cracking units and fluid coking units with rated capacities of 10,000 barrels per stream day or less that do not use a continuous CO₂ CEMS for the final exhaust stack, but that monitor at least daily the O₂, CO₂ and (if necessary) CO concentrations in the exhaust stack from the catalytic cracking unit regenerator or fluid coking unit burner prior to the combustion of other fossil fuels.

Figure 19
Equation Y-6 Details Schema Diagram

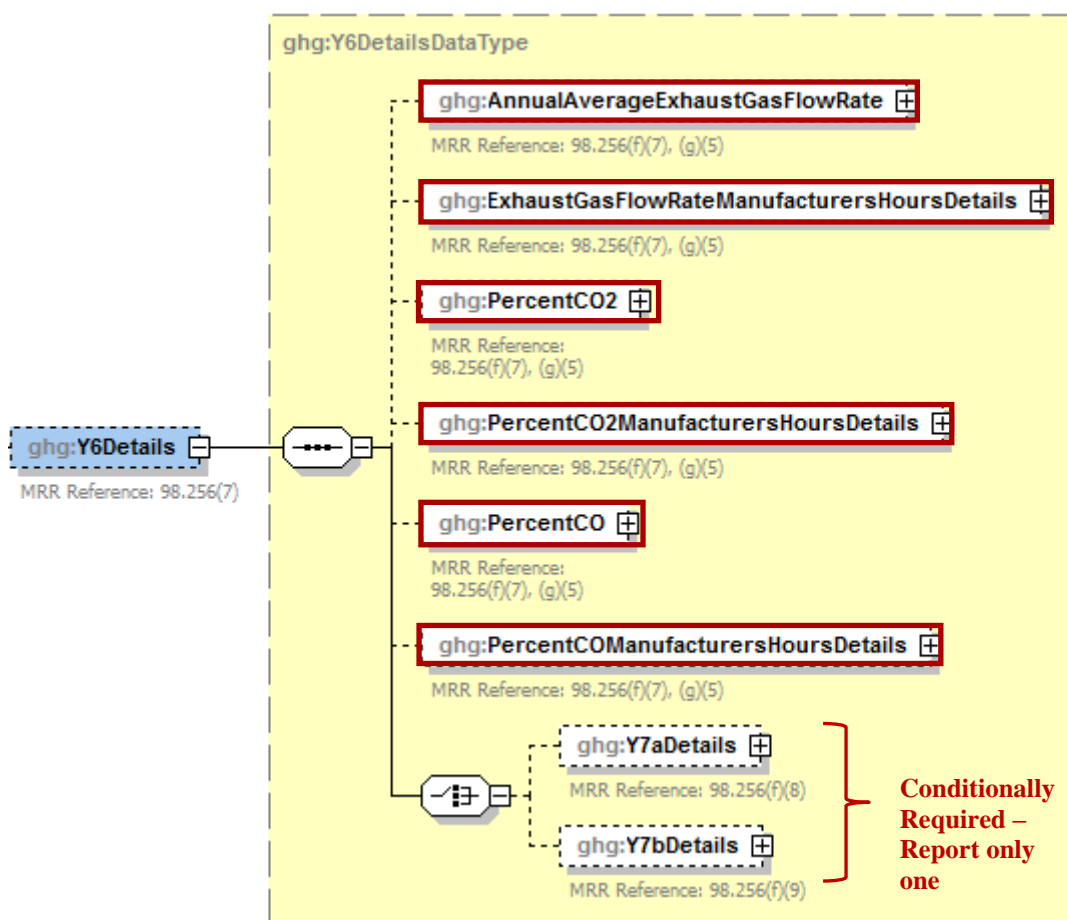

Note: Data elements boxed in red are required. Please see page 4 of this document for more information on conditionally required elements.

Method 1: 98.253(c)(2) - Equation Y-6 and continuous monitor for flow

If you continuously monitored the volumetric flow rate of exhaust gas from the fluid catalytic cracking unit regenerator or fluid coking unit burner prior to the combustion of other fossil fuels, you are required to report the following:

- Annual average volumetric flow rate of exhaust gas from the unit prior to the combustion of other fossil fuels (dscf/hour) and the number of hours that missing data procedures were used. (If using Equation Y-7a or Y-7b, replace this value with the result of the equation.)
- A description of the manufacturer's recommended methods used to determine the following:
 - Annual average volumetric flow rate of exhaust gas
 - Hourly average percentage of CO₂ concentration in the exhaust gas stream
 - Hourly average percentage of CO concentration in the exhaust gas stream, if applicable.
- Hourly average percentage of CO₂ concentration (and CO, if applicable) in the exhaust gas stream from the unit (percent by volume – dry basis). Also report the number of hours that missing data procedures were used.

Note: The information above is required if Equation Y-6 was used.

Table 17
Equation Y-6 Details Data Element Definitions

Data Element Name	Description
Y6Details	Parent Element (Conditionally Required)
AnnualAverageExhaustGasFlowRate	The annual average volumetric flow rate of exhaust gas from the fluid catalytic cracking unit prior to the combustion of other fossil fuels. [98.256(f)(7), (g)(5)] Report the value in the child data element MeasureValue . Set the units of measure to “dscf/hour” in the attribute rateUOM . Also report the number of hours that missing data procedures were used for the annual average volumetric flow rate of exhaust gas in the child data element NumberOfTimesSubstituted . [98.3(c)(8)]
ExhaustGasFlowRateManufacturersHoursDetails	Parent Element
ManufacturersMethod	Specify the manufacturer’s recommended method that was used to determine the annual average volumetric flow rate of exhaust gas. [98.256(q)]
PercentCO2	The annual average percent of CO ₂ in the exhaust gas stream. [98.256(f)(7), (g)(5)] Report the value in the child data element MeasureValue . Set the units of measure to “Number (between 0 and 100)” in the attribute percentUOM . Also report the number of hours that missing data procedures were used to determine the annual average percent of CO ₂ in the exhaust gas stream in the child data element NumberOfTimesSubstituted . [98.3(c)(8)]
PercentCO2ManufacturersHoursDetails	Parent Element
ManufacturersMethod	Specify the manufacturer’s recommended method that was used to determine the annual average percent of CO ₂ in the exhaust gas stream. [98.256(q)]

Data Element Name	Description
PercentCO	The annual average percent of CO in the exhaust gas stream. [98.256(f)(7), (g)(5)] Report the value in the child data element MeasureValue . Set the units of measure to “Number (between 0 and 100)” in the attribute percentUOM . Also report the number of hours that missing data procedures were used to determine the annual average percent of CO in the exhaust gas stream in the child data element NumberofTimesSubstituted . [98.3(c)(8)]
PercentCOManufacturersHoursDetails	Parent Element
ManufacturersMethod	Specify the manufacturer’s recommended method that was used to determine the annual average percent of CO in the exhaust gas stream. [98.256(q)]

**XML Excerpt 13
Example for Equation Y-6**

```

<ghg:Y6Details>
  <ghg:AnnualAverageExhaustGasFlowRate rateUOM="dscf/hour">
    <ghg:MeasureValue>232,2345</ghg:MeasureValue>
    <ghg:NumberofTimesSubstituted>65</ghg:NumberofTimesSubstituted>
  </ghg:AnnualAverageExhaustGasFlowRate>
  <ghg:ExhaustGasFlowRateManufacturersHoursDetails>
    <ghg:ManufacturersMethod>Manufacturer's test method 1</ghg:ManufacturersMethod>
  </ghg:ExhaustGasFlowRateManufacturersHoursDetails>
  <ghg:PercentCO2 percentUOM="Number (between 0 and 100)">
    <ghg:MeasureValue>67</ghg:MeasureValue>
    <ghg:NumberofTimesSubstituted>67</ghg:NumberofTimesSubstituted>
  </ghg:PercentCO2>
  <ghg:PercentCO2ManufacturersHoursDetails>
    <ghg:ManufacturersMethod> Manufacturer's test method 2</ghg:ManufacturersMethod>
  </ghg:PercentCO2ManufacturersHoursDetails>
  <ghg:PercentCO percentUOM="Number (between 0 and 100)">
    <ghg:MeasureValue>2</ghg:MeasureValue>
    <ghg:NumberofTimesSubstituted>2</ghg:NumberofTimesSubstituted>
  </ghg:PercentCO>
  <ghg:PercentCOManufacturersHoursDetails>
    <ghg:ManufacturersMethod>Manufacturer's test method 3</ghg:ManufacturersMethod>
  </ghg:PercentCOManufacturersHoursDetails>
</ghg:Y6Details>

```

Note: The XML example above is presented here to demonstrate the concept of reporting details for Equation Y-6.



In addition to Equation Y-6, did you use Equation Y-7a or Equation Y-7b to calculate the volumetric flow rate of exhaust gas from the fluid catalytic cracking unit regenerator or fluid coking unit burner?



If you calculated the volumetric flow rate of exhaust gas from the fluid catalytic cracking unit regenerator or fluid coking unit burner using Equation Y-7a, see [Equation Y-7a Details Schema Diagram](#) and the instructions following it on how to report for the parent element “Y7aDetails.”



If you calculated the volumetric flow rate of exhaust gas from the fluid catalytic cracking unit regenerator or fluid coking unit burner using Equation Y-7b, see [Equation Y-7b Details Schema Diagram](#) and the instructions following it on how to report for the parent element “Y7bDetails.”



If you used Equation Y-6 and did not use Equation Y-7a or Equation Y-7b, proceed to [Section 3.2](#) for instructions on how to report for a unit monitored by CEMS or [Section 4.1](#) for required subpart-level summary data for sour gas sent off-site.

Figure 20
Equation Y-7a Details Schema Diagram

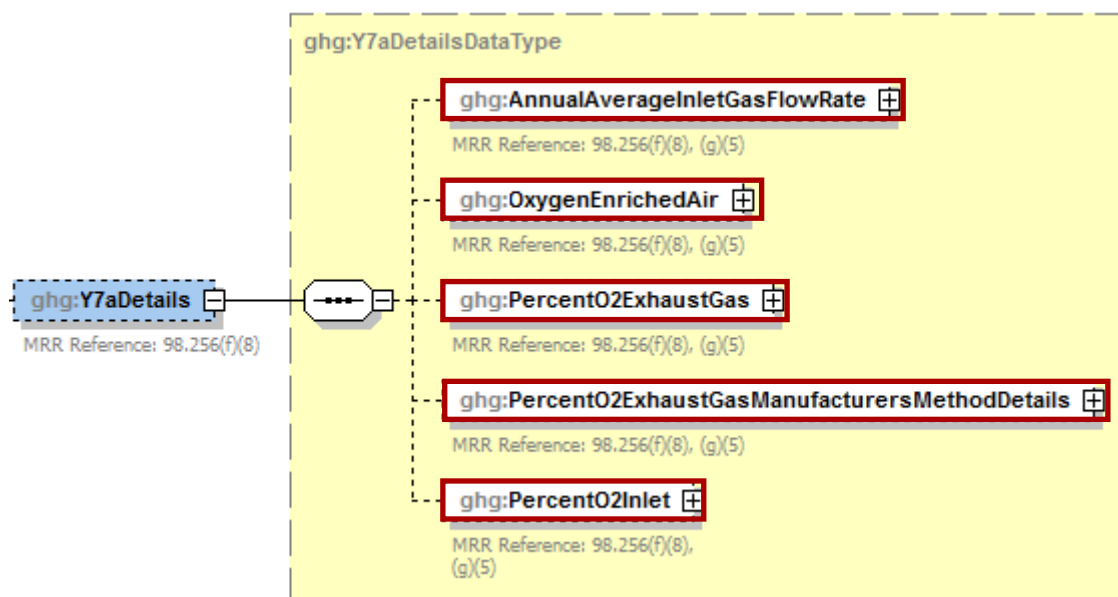

Note: Data elements boxed in red are required.

Method 2: 98.253(c)(2) - Equation Y-6 and Equation Y-7a

Conditionally Required: If you calculated the volumetric flow rate of exhaust gas from the fluid catalytic cracking unit regenerator or fluid coking unit burner using Equation Y-7a, then report the following information, in addition to the items referenced under Method 1:

- Annual average volumetric flow rate of inlet air to the unit, as determined from control room instrumentation (dscf/hour).
- Annual average volumetric flow rate of oxygen-enriched air inlet to the unit, as determined from control room instrumentation (dscf/hour).
- The annual average percent of O₂ in the exhaust gas stream. Also report the number of hours missing data procedures were used to determine the annual average percent of O₂ in the exhaust gas stream.
- Description of the manufacturer's recommended method used to determine the annual average percentage of O₂ concentration in the exhaust gas stream.
- The annual average percentage of O₂ concentration in the oxygen-enriched gas stream inlet to the unit based on oxygen purity specifications of the oxygen supply used for enrichment (percent by volume – dry basis).

Table 18
Equation Y-7a Details Data Element Definitions

Data Element Name	Description
Y7aDetails	Parent Element (Conditionally Required)
AnnualAverageInletGasFlowRate	The annual average flow rate of inlet air. Report the value in the child data element MeasureValue . Set the units of measure to “dscf/hour” in the attribute rateUOM . [98.256(f)(8), (g)(5)]
OxygenEnrichedAir	The annual average flow rate of oxygen-enriched air. Report the value in the child data element MeasureValue . Set the units of measure to “dscf/hour” in the attribute rateUOM . [98.256(f)(8), (g)(5)]
PercentO2ExhaustGas	The annual average percent of O ₂ in the exhaust gas stream. [98.256(f)(8), (g)(5)] Report the value in the child data element MeasureValue . Set the units of measure to “Number (between 0 and 100)” in the attribute percentUOM . Also report the number of hours missing data procedures were used to determine the annual average percent of O ₂ in the exhaust gas stream in the child data element NumberofTimesSubstituted . [98.3(c)(8)]
PercentO2ExhaustGasManufacturersMethodDetails	Parent Element
ManufacturersMethod	Specify the manufacturer’s recommended method that was used to determine the annual average percent of O ₂ in the exhaust gas stream. [98.256(q)]
PercentO2Inlet	The annual average percent of O ₂ in the oxygen-enriched gas stream inlet. Report the value in the child data element MeasureValue . Set the units of measure to “Number (between 0 and 100)” in the attribute percentUOM . [98.256(f)(8), (g)(5)]

XML Excerpt 14 Example for Equation Y-7a

```

<ghg:Y7aDetails>
  <ghg:AnnualAverageInletGasFlowRate rateUOM="dscf/hour">
    <ghg:MeasureValue>45.5675</ghg:MeasureValue>
  </ghg:AnnualAverageInletGasFlowRate>
  <ghg:OxygenEnrichedAir rateUOM="dscf/hour">
    <ghg:MeasureValue>35.456</ghg:MeasureValue>
  </ghg:OxygenEnrichedAir>
  <ghg:PercentO2ExhaustGas percentUOM="Number (between 0 and 100)">
    <ghg:MeasureValue>75</ghg:MeasureValue>
    <ghg:NumberofTimesSubstituted>0</ghg:NumberofTimesSubstituted>
  </ghg:PercentO2ExhaustGas>
  <ghg:PercentO2ExhaustGasManufacturersMethodDetails>
    <ghg:ManufacturersMethod>Test Method 3</ghg:ManufacturersMethod>
  </ghg:PercentO2ExhaustGasManufacturersMethodDetails>
  <ghg:PercentO2Inlet percentUOM="Number (between 0 and 100)">
    <ghg:MeasureValue>66</ghg:MeasureValue>
  </ghg:PercentO2Inlet>
</ghg:Y7aDetails>

```

Note: The XML example above is presented here to demonstrate the concept of reporting details for Equation Y-7a.

➡ Proceed to [Section 3.2](#) for instructions on how to report for a unit monitored by CEMS or [Section 4.1](#) for required subpart-level summary data for sour gas sent off-site.

Figure 21
Equation Y-7b Details Schema Diagram

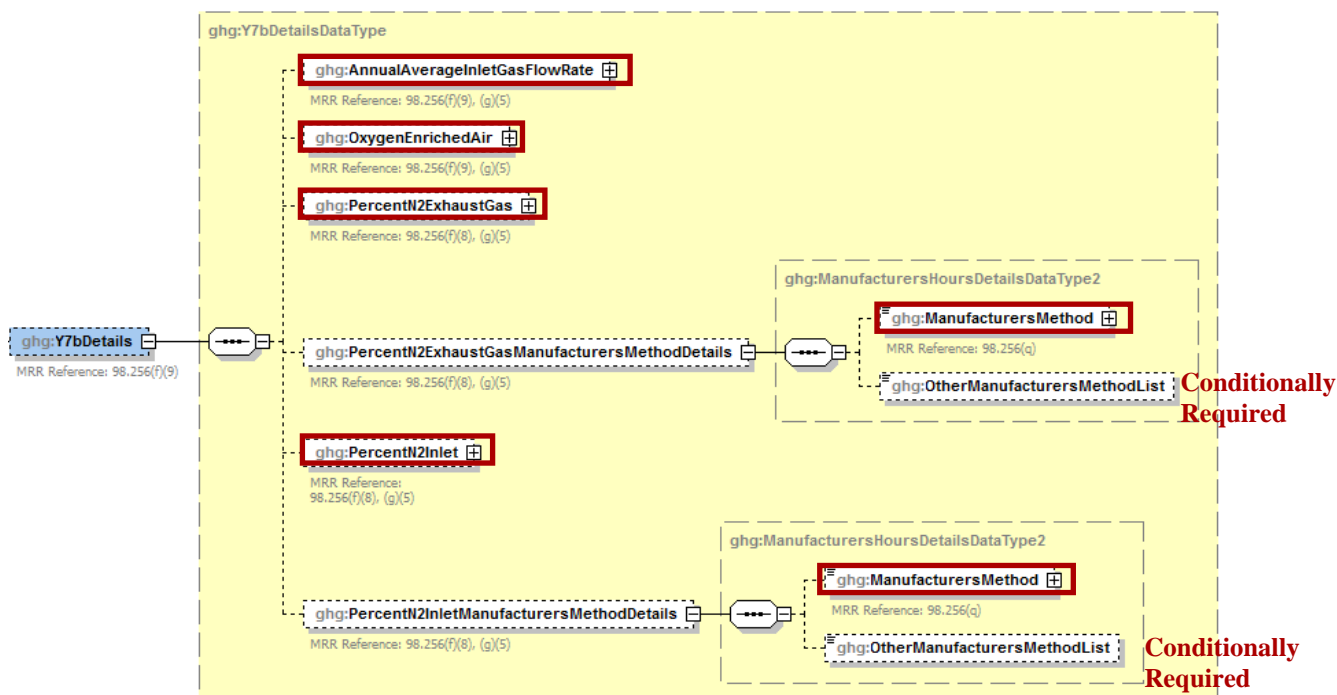

Note: Data elements boxed in red are required. Please see page 4 of this document for more information on conditionally required elements.

Method 3: 98.253(c)(2) - Equation Y-6 and Equation Y-7b

Conditionally Required: If you calculated the volumetric flow rate of exhaust gas from the fluid catalytic cracking unit regenerator or fluid coking unit burner using Equation Y-7b, then report the following information, in addition to the items referenced under Method 1:

- Annual average volumetric flow rate of inlet air to the unit, as determined from control room instrumentation (dscf/hour).
- Annual average volumetric flow rate of oxygen-enriched air to the unit, as determined from control room instrumentation (dscf/hour).
- Hourly average percentage of N₂ concentration in the exhaust gas stream from the fluid catalytic cracking unit regenerator or fluid coking unit burner (percent by volume – dry basis) including the number of hours that missing data procedures were used.
- Description of the manufacturer's recommended method used to determine the hourly average percentage of N₂ concentration in the exhaust gas stream.
 - Method 18 at 40 CFR part 60, appendix A-6
 - ASTM D1945-03
 - ASTM D1946-90-Reapproved 2006
 - GPA 2261-00
 - UOP539-97
 - ASTM D2503-92-Reapproved 2007
 - Chromatographic analysis: manufacturer's instructions

- Maximum N₂ impurity specification
- Other (specify)
- N₂ concentration in the oxygen-enriched gas stream inlet to the unit based on oxygen purity specifications of the oxygen supply used for enrichment (percent by volume – dry basis) including the number of hours that missing data procedures were used.
- Description of the manufacturer's recommended method used to determine the N₂ concentration in the oxygen-enriched gas stream inlet to the unit, if applicable.
 - Method 18 at 40 CFR part 60, appendix A-6
 - ASTM D1945-03
 - ASTM D1946-90-Reapproved 2006
 - GPA 2261-00
 - UOP539-97
 - ASTM D2503-92-Reapproved 2007
 - Chromatographic analysis: manufacturer's instructions
 - Maximum N₂ impurity specification
 - Other (specify)

Table 19
Equation Y-7b Details Data Element Definitions

Data Element Name	Description
Y7bDetails	Parent Element (Conditionally Required)
AnnualAverageInletGasFlowRate	The annual average flow rate of inlet air. Report the value in the child data element MeasureValue . Set the units of measure to “dscf/hour” in the attribute rateUOM . [98.256(f)(9), (g)(5)]
OxygenEnrichedAir	The annual average flow rate of oxygen-enriched air. Report the value in the child data element MeasureValue . Set the units of measure to “dscf/hour” in the attribute rateUOM . [98.256(f)(9), (g)(5)]
PercentN2ExhaustGas	The annual average percent of N ₂ in the exhaust gas stream. [98.256(f)(9), (g)(5)] Report the value in the child data element MeasureValue . Set the units of measure to “Number (between 0 and 100)” in the attribute percentUOM . Also report the number of hours missing data procedures were used to determine the annual average percent of N ₂ in the exhaust gas stream in the child data element NumberofTimesSubstituted . [98.3(c)(8)]
PercentN2ExhaustGasManufacturersMethodDetails	Parent Element

Data Element Name	Description
ManufacturersMethod	<p>Specify the method that was used to determine the annual average percent of N₂ in the exhaust gas stream. Below is the list of allowable values. [98.256(q)]</p> <p>Method 18 at 40 CFR part 60, appendix A-6 ASTM D1945-03 ASTM D1946-90 (Reapproved 2006) GPA 2261-00 UOP539-97 ASTM D2503-92 (Reapproved 2007) Chromatographic analysis: manufacturer's instructions Maximum N2 impurity specification Other (specify)</p>
OtherManufacturersMethodList	<p>Conditionally Required: The method that was used to determine the annual average percent of N₂ in the exhaust gas stream if not referenced in the list of allowable values.</p>
PercentN2Inlet	<p>The annual average percent of N₂ in the oxygen-enriched gas stream inlet. [98.256(f)(9), (g)(5)] Report the value in the child data element MeasureValue. Set the units of measure to "Number (between 0 and 100)" in the attribute percentUOM. Also report the number of hours missing data procedures were used to determine the annual average percent of N₂ in the oxygen-enriched gas stream inlet in the child data element NumberofTimesSubstituted. [98.3(c)(8)]</p>
PercentN2InletManufacturersMethodDetails	Parent Element
ManufacturersMethod	<p>Specify the method that was used to determine the annual average percent of N₂ in the oxygen-enriched gas stream inlet. Below is the list of allowable values. [98.256(q)]</p> <p>Method 18 at 40 CFR part 60, appendix A-6 ASTM D1945-03 ASTM D1946-90 (Reapproved 2006) GPA 2261-00 UOP539-97 ASTM D2503-92 (Reapproved 2007) Chromatographic analysis: manufacturer's instructions Maximum N2 impurity specification Other (specify)</p>
OtherManufacturersMethodList	<p>Conditionally Required: The method that was used to determine the annual average percent of N₂ in the oxygen-enriched gas stream inlet if not referenced in the list of allowable values.</p>

XML Excerpt 15 Example for Equation Y-7b

```

<ghg:Y7bDetails>
  <ghg:AnnualAverageInletGasFlowRate rateUOM="dscf/hour">
    <ghg:MeasureValue>564.456</ghg:MeasureValue>
  </ghg:AnnualAverageInletGasFlowRate>
  <ghg:OxygenEnrichedAir rateUOM="dscf/hour">
    <ghg:MeasureValue>345</ghg:MeasureValue>
  </ghg:OxygenEnrichedAir>
  <ghg:PercentN2ExhaustGas percentUOM="Number (between 0 and 100)">
    <ghg:MeasureValue>45</ghg:MeasureValue>
    <ghg:NumberOfTimesSubstituted>3</ghg:NumberOfTimesSubstituted>
  </ghg:PercentN2ExhaustGas>
  <ghg:PercentN2ExhaustGasManufacturersMethodDetails>
    <ghg:ManufacturersMethod>Method 18 at 40 CFR part 60, appendix A-6</ghg:ManufacturersMethod>
  </ghg:PercentN2ExhaustGasManufacturersMethodDetails>
  <ghg:PercentN2Inlet percentUOM="Number (between 0 and 100)">
    <ghg:MeasureValue>3</ghg:MeasureValue>
    <ghg:NumberOfTimesSubstituted>70</ghg:NumberOfTimesSubstituted>
  </ghg:PercentN2Inlet>
  <ghg:PercentN2InletManufacturersMethodDetails>
    <ghg:ManufacturersMethod>UOP539-97</ghg:ManufacturersMethod>
  </ghg:PercentN2InletManufacturersMethodDetails>
</ghg:Y7bDetails>
    
```

Note: The XML example above is presented here to demonstrate the concept of reporting details for Equation Y-7b.

➔ Proceed to [Section 3.2](#) for instructions on how to report for a unit monitored by CEMS or [Section 4.1](#) for required subpart-level summary data for sour gas sent off-site.

3.1.2 Equation Y-8 Details

This topic provides a step-by-step description of how to report details about the method used to calculate CO₂ emissions from catalytic cracking units and fluid coking units with rated capacities of 10,000 barrels per stream day or less that do not use a continuous CO₂ CEMS for the final exhaust stack.

**Figure 22
Equation Y-8 Details Schema Diagram**

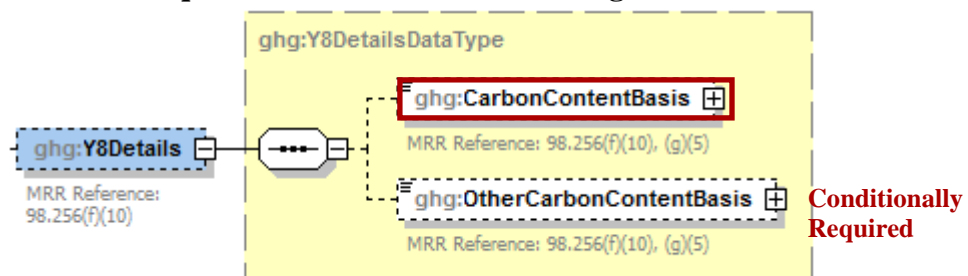

Note: Data elements boxed in red are required. Please see page 4 of this document for more information on conditionally required elements.

Conditionally Required: If you do not monitor at least daily the O₂, CO₂ and (if necessary) CO concentrations in the exhaust stack from the catalytic cracking unit regenerator or fluid coking unit burner prior to the combustion of other fossil fuels, calculate the CO₂ emissions from each catalytic cracking unit and fluid coking unit using Equation Y-8.

For each unit using the Equation Y-8 calculation method, identify the basis for the carbon content value:

- Weekly or more frequent measurements
- Periodic (less frequent than weekly but at least quarterly) measurements
- Semi-annual or annual measurements
- Historical measurement value
- Engineering estimate
- Default value
- Other

Table 20
Equation Y-8 Details Data Element Definitions

Data Element Name	Description
Y8Details	Parent Element (Conditionally Required)
CarbonContentBasis	<p>The basis for the carbon content value. [98.256(f)(10), (g)(5)] Below is the list of allowable values.</p> <p>Weekly or more frequent measurements Periodic (less frequent than weekly but at least quarterly) measurements Semi-annual or annual measurements Historical measurement value Engineering estimate Default value Other (specify)</p>
OtherCarbonContentBasis	Specify the basis for the carbon content value if not referenced above. [98.256(f)(10), (g)(5)]

XML Excerpt 16
Example for Equation Y-8

```
<ghg:Y8Details>
  <ghg:CarbonContentBasis>Other (specify)</ghg:CarbonContentBasis>
  <ghg:OtherCarbonContentBasis>Bi-weekly</ghg:OtherCarbonContentBasis>
</ghg:Y8Details>
```

Note: The XML example above is presented here to demonstrate the concept of reporting details for Equation Y-8.



Proceed to [Section 3.2](#) for instructions on how to report for a unit monitored by CEMS or [Section 4.1](#) for required subpart-level summary data for sour gas sent off-site.

3.1.3 Equation Y-11 Details

This topic provides a step-by-step description of how to report details about the method used to calculate CO₂ emissions from catalytic reforming catalyst regenerator units.

Figure 23
Equation Y-11 Details Schema Diagram

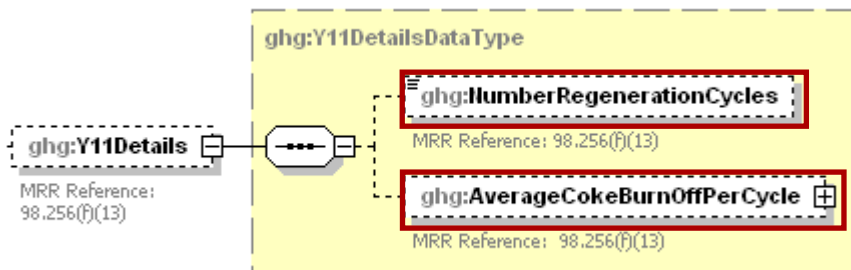

Note: Data elements boxed in red are required.

Conditionally Required: For each catalytic reforming unit using the Equation Y-11 calculation method, you are required to report the following:

- The total number of regeneration cycles or measurement periods. [98.256(f)(13)]
- The average coke burn-off quantity per cycle or measurement period. [98.256(f)(13)]

Table 21
Equation Y-11 Data Element Definitions

Data Element Name	Description
Y11Details	Parent Element (Conditionally Required)
NumberRegenerationCycles	The total number of regeneration cycles or measurement periods in the calendar year (integer). [98.256(f)(13)]
AverageCokeBurnOffPerCycle	The average coke burn-off quantity per cycle or measurement period. Report the value in the child data element MeasureValue . Set the units of measure to “kg/cycle or kg/measurement period” in the attribute rateUOM . [98.256(f)(13)]

XML Excerpt 17
Example for Equation Y-11

```

<ghg:Y11Details>
  <ghg:NumberRegenerationCycles>3</ghg:NumberRegenerationCycles>
  <ghg:AverageCokeBurnOffPerCycle rateUOM="kg/cycle or kg/measurement period">
    <ghg:MeasureValue>345</ghg:MeasureValue>
  </ghg:AverageCokeBurnOffPerCycle>
</ghg:Y11Details>
</ghg:CrackingCokingReformingUnitDetails>
    
```

Note: The XML example above is presented here to demonstrate the concept of reporting details for Equation Y-11 (Catalytic Reforming unit).

➔ Proceed to [Section 3.2](#) for instructions on how to report for a unit monitored by CEMS or [Section 4.1](#) for required subpart-level summary data for sour gas sent off-site.

3.2 Cracking Coking CEMS Unit Details

For each catalytic cracking, fluid coking and catalytic reforming unit that is monitored with a CEMS to measure CO₂ emissions, according to the guidelines specified in Subpart C, report the unit’s identification information.

Figure 24
Cracking Coking CEMS Details Schema Diagram

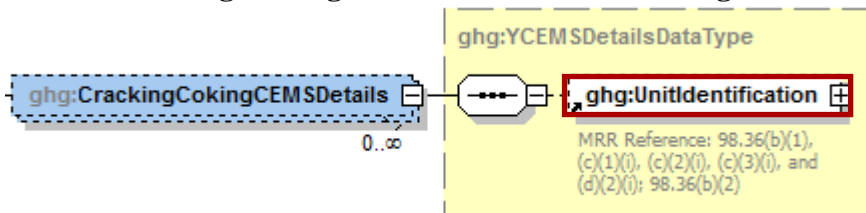

Note: Data elements boxed in red are required.

In addition to reporting the identification of each catalytic reforming unit that is monitored with a CEMS, you must report the relevant information required under 98.36 for the Tier 4 Calculation Methodology. See instructions for reporting parent element “[YTier4CEMSDetails](#)” in this document.

Note: Use the same identification for the unit as was used for the parent element “CrackingCokingReformingUnitDetails”.

Table 22
Cracking Coking CEMS Details Data Element Definitions

Data Element Name	Description
CrackingCokingCEMSDetails	Parent Element (Conditionally Required)
UnitIdentification	<p>A collection of data elements containing the identity of each CEMS cracking coking or reforming unit. Report a unique unit name (ID) in the child data element UnitName, an optional brief description in the child data element UnitDescription and the type of unit in the child data element UnitType. Report one of the following unit types:</p> <ul style="list-style-type: none"> Fluid Catalytic Cracking Unit Thermal Catalytic Cracking Unit Traditional Fluid Coking Unit Catalytic Reforming Unit Fluid Coking Unit with Flexicoking Design <p>Note: Use the same identification for the unit as was used for the parent element “CrackingCokingReformingUnitDetails”.</p>

XML Excerpt 18
Example for Cracking Coking CEMS Details

```

<CrackingCokingCEMSDetails>
  <UnitIdentification>
    <UnitName>CC-CEMS-001</UnitName>
    <UnitType>Fluid Catalytic Cracking Unit</UnitType>
  </UnitIdentification>
</CrackingCokingCEMSDetails>
    
```

Note: The XML example above is presented here to demonstrate the concept of reporting the identification of each catalytic reforming unit that is monitored with a CEMS.

4.0 Sulfur Recovery Details

4.1 Sour Gas Sent Off-site

Required Subpart-Level Summary Data

For petroleum refinery sources required to report under Subpart Y, you are required to report the annual CO₂ emissions from sour gas sent off-site for sulfur recovery. You must also report information about the annual volume of sour gas fed to the sulfur recovery plant and the annual average mole fraction of carbon in the sour gas.

Figure 25
Sour Gas Sent Off-site Schema Diagram

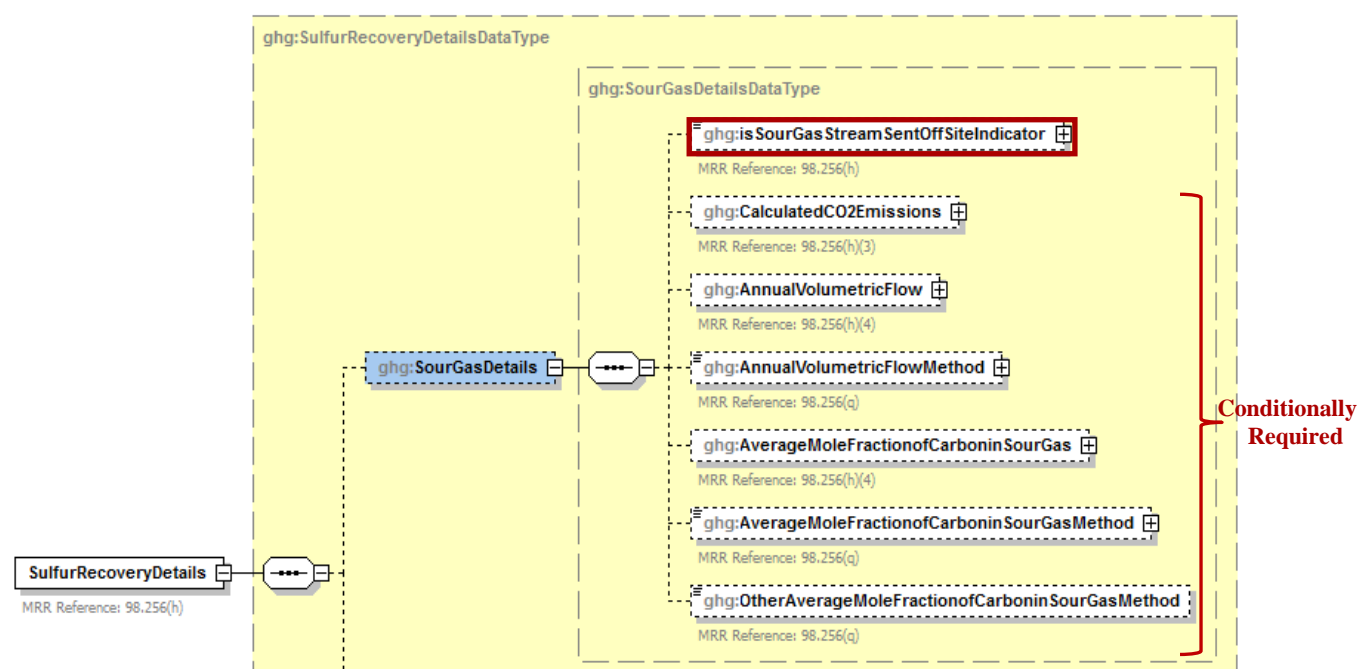

Note: Data elements boxed in red are required. Please see page 4 of this document for more information on conditionally required elements.

Equation Y-12

If you use Equation Y-12 to calculate the cumulative CH₄ emissions from sour gas sent off-site, you can download the Y-12 spreadsheet from the e-GGRT help site or use the following information:

$$CO_2 = F_{SG} * \frac{44}{MVC} * MF_C * 0.001$$

Where:

- CO₂ = Annual CO₂ emissions (metric tons/year).
- F_{SG} = Volumetric flow rate of sour gas feed (including sour water stripper gas) to the sulfur recovery plant (scf/year).
- 44 = Molecular weight of CO₂ (kg/kg-mole).
- MVC = Molar volume conversion factor (849.5 scf/kg-mole at 68 °F and 14.7 psia or 836.6 scf/kg-mole at 60 °F and 14.7 psia).
- MF_C = Mole fraction of carbon in the sour gas to the sulfur recovery plant (kg-mole C/kg-mole gas); default = 0.20.
- 0.001 = Conversion factor, kg to metric tons

Table 23
Sour Gas Sent Off-site Data Element Definitions

Data Element Name	Description
SulfurRecoveryDetails	Parent Element: A collection of data elements containing details about the calculated annual CO ₂ emissions from sour gas sent off-site for sulfur recovery and the calculated CO ₂ annual emissions for each sulfur recovery plant.
SourGasDetails	Parent Element
isSourGasStreamSentOffSiteIndicator	An indication (Y/N) of whether the facility sends a sour gas stream off-site for sulfur recovery. [98.256(h)]
CalculatedCO2Emissions	Conditionally Required: If sour gas is sent off-site, then report the calculated annual CO ₂ emissions from sour gas sent off-site for sulfur recovery, expressed in metric tons. Report the value in the child data element CalculatedValue . Set the units of measure to “Metric Tons” in the attribute massUOM . [98.256(h)(3)]
AnnualVolumetricFlow	Conditionally Required: If measured, the number of hours that missing data procedures were used to determine the annual volume of sour gas fed. Report the number of hours in the child data element NumberOfTimesSubstituted . [98.3(c)(8)]
AnnualVolumetricFlowMethod	Conditionally Required: If measured, indicate the specific consensus-based standard method or description of the procedure specified by the flow meter manufacturer to measure annual volume of sour gas fed. [98.256(q)]
AverageMoleFractionofCarboninSourGas	Conditionally Required: If measured, the number of hours that missing data procedures were used to determine the annual average mole fraction of carbon in the sour gas. Report the number of hours in the child data element NumberOfTimesSubstituted . [98.3(c)(8)]
AverageMoleFractionofCarboninSourGasMethod	Conditionally Required: If measured, describe the method used to measure the annual average mole fraction of carbon in the sour gas. [98.256(q)] Below is the list of allowable values. Method 18 at 40 CFR part 60, appendix A-6 ASTM D1945-03 ASTM D1946-90 (Reapproved 2006) GPA 2261-00 UOP539-97 ASTM D2503-92 (Reapproved 2007) Chromatographic analysis: manufacturer’s instructions Other (specify)

Data Element Name	Description
OtherAverageMoleFractionofCarboninSourGasMethod	Conditionally Required: Method used to measure the annual average mole fraction of carbon in the sour gas if not listed above.

XML Excerpt 19 Example for Sour Gas Sent Off-site

```

<ghg:SulfurRecoveryDetails>
  <ghg:SourGasDetails>
    <ghg:isSourGasStreamSentOffSiteIndicator>Y</ghg:isSourGasStreamSentOffSiteIndicator>
    <ghg:CalculatedCO2Emissions massUOM ="Metric Tons">
      <ghg:CalculatedValue>250.8</ghg:CalculatedValue>
    </ghg:CalculatedCO2Emissions>
    <ghg:AnnualVolumetricFlow>
      <ghg:NumberOfTimesSubstituted>1</ghg:NumberOfTimesSubstituted>
    </ghg:AnnualVolumetricFlow>
    <ghg:AnnualVolumetricFlowMethod>Standard sour gas fed to plant</ghg:AnnualVolumetricFlowMethod>
    <ghg:AverageMoleFractionofCarboninSourGas>
      <ghg:NumberOfTimesSubstituted>2</ghg:NumberOfTimesSubstituted>
    </ghg:AverageMoleFractionofCarboninSourGas>
    <ghg:AverageMoleFractionofCarboninSourGasMethod> ASTM D1946-90 (Reapproved
      2006)</ghg:AverageMoleFractionofCarboninSourGasMethod>
  </ghg:SourGasDetails>

```

Note: The XML example above is presented here to demonstrate the concept of reporting sour gas information.

Does the facility have any sulfur recovery plants to report?

 If the facility has any sulfur recovery plants, see [Section 4.2](#) for instructions on how to report for the parent element “SulfurRecoveryUnitDetails.”

Does the facility have any coke calcining unit information to report?

 If the facility has any coke calcining units, see [Section 5.0](#) for instructions on how to report for the parent element “CokeCalciningDetails.”

Does the facility have any asphalt blowing units to report?

 If the facility has any asphalt blowing units, see [Section 6.0](#) for instructions on how to report for the parent element “AsphaltBlowingDetails.”

 If the facility has neither sulfur recovery plants, coke calcining units, nor asphalt blowing units, see [Section 7.1](#) for required subpart-level reporting for the parent element “DelayedCokingDetails.”

4.2 Sulfur Recovery Plant Information

Conditionally Required Unit-Level Data

This topic provides a step-by-step description of how to report Sulfur Recovery Plant information for your facility. You are required to report CO₂ process emissions from each on-site sulfur recovery plant subject to this Subpart.

Figure 26
Sulfur Recovery Details Schema Diagram

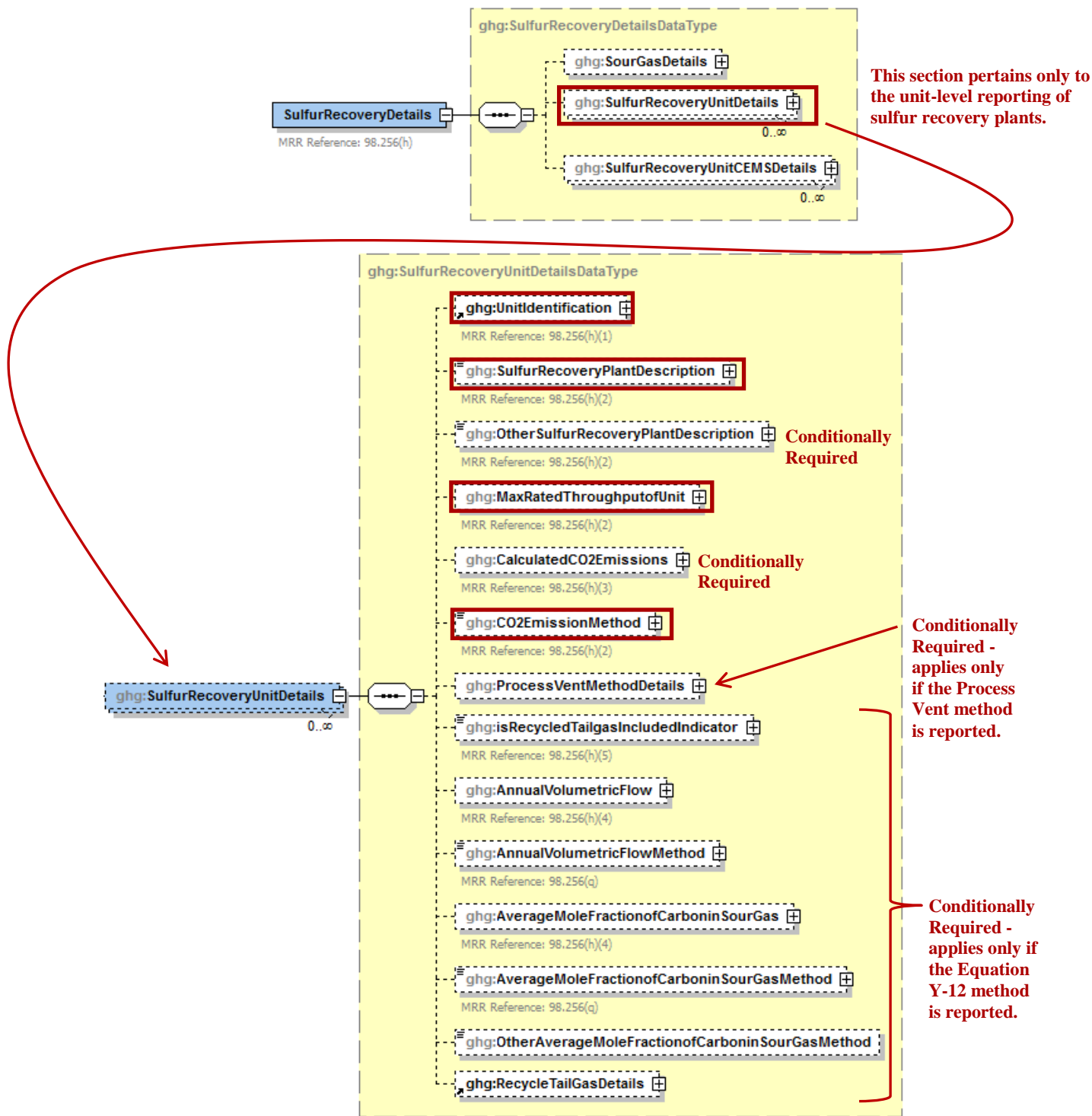

Note: Data elements boxed in red are required. Please see page 4 of this document for more information on conditionally required elements.

Subpart Y collects the following data about each sulfur recovery plant:

- A unique name or identifier, plus optional description
 - Type (description) of sulfur recovery plant:
 - Caustic scrubber
 - Claus
 - Lo-cat
 - Sulfuric acid plant
 - Other (specify)
 - Maximum rated throughput of the sulfur recovery plant (metric tons sulfur per stream day)
 - **Conditionally Required:** If the unit is not monitored by a CEMS, report the calculated CO₂ annual emissions of the sulfur recovery plant expressed in metric tons.
 - Method used to calculate the CO₂ emissions.
 - CO₂ CEMS
 - Equation Y-12
 - Process Vent Method
- Note:** The Process Vent Method does not apply to Claus plants.

Table 24
Sulfur Recovery Unit Details Data Element Definitions

Data Element Name	Description
SulfurRecoveryUnitDetails	Parent Element (Conditionally Required)
UnitIdentification	A collection of data elements containing the identity of each sulfur recovery plant unit. Report a unique unit name (ID) in the child data element UnitName , an optional brief description in the child data element UnitDescription and the type of unit in the child data element UnitType . [98.256(h)(1)] Report the following unit type: Sulfur Recovery Plant
SulfurRecoveryPlantDescription	The type of sulfur recovery plant. Below is the list of allowable values. [98.256(h)(2)] Caustic scrubber Claus Lo-cat Sulfuric acid plant Other (specify)
OtherSulfurRecoveryPlantDescription	Conditionally Required: Specify the type of sulfur recovery plant you are reporting if your type is not listed above.
MaxRatedThroughputofUnit	Maximum rated throughput of the specified sulfur recovery plant. Report the value in the child data element MeasureValue . Set the units of measure to “metric tons/streamday” in the attribute rateUOM . [98.256(h)(2)]

Data Element Name	Description
CalculatedCO2Emissions	Conditionally Required: The calculated CO ₂ annual emissions for the sulfur recovery plant if not monitored by a CEMS, expressed in metric tons. Report the value in the child data element CalculatedValue . Set the units of measure to “Metric Tons” in the attribute massUOM . [98.256(h)(3)]
CO2EmissionMethod	The method used to calculate CO ₂ annual emissions for the sulfur recovery plant. [98.256(h)(2)] Below is the list of allowable values. CO2 CEMS Equation Y-12 Process Vent Method Note: The Process Vent Method does not apply to Claus plants.

XML Excerpt 20 Example for Sulfur Recovery Units

```

<ghg:SulfurRecoveryUnitDetails>
  <ghg:UnitIdentification>
    <ghg:UnitName>SR-NC-001</ghg:UnitName>
    <ghg:UnitDescription>Eastman Factory</ghg:UnitDescription>
    <ghg:UnitType>Sulfur Recovery Plant</ghg:UnitType>
  </ghg:UnitIdentification>
  <ghg:SulfurRecoveryPlantDescription>Caustic scrubber</ghg:SulfurRecoveryPlantDescription>
  <ghg:MaxRatedThroughputofUnit rateUOM="metric tons/streamday">
    <ghg:MeasureValue>23444</ghg:MeasureValue>
  </ghg:MaxRatedThroughputofUnit>
  <ghg:CalculatedCO2Emissions massUOM="Metric Tons">
    <ghg:CalculatedValue>45343.2</ghg:CalculatedValue>
  </ghg:CalculatedCO2Emissions>
  <ghg:CO2EmissionMethod>Equation Y-12</ghg:CO2EmissionMethod>

```

Note: The XML example above is presented here to demonstrate the concept of reporting details for sulfur recovery plant units.



Which method was used to calculate CO₂ emissions?



If CEMS was used, see “[Sulfur Recovery CEMS Details](#)” for instructions on how to report for the parent element “SulfurRecoveryUnitCEMSDetails.”



If Equation Y-12 was used, see “[Equation Y-12 Details](#)” for instructions on how to report additional information.



If the Process Vent method was used, see “[Process Vent Method Details](#)” for instructions on how to report for the parent element “ProcessVentMethodDetails.”

Figure 27
Process Vent Method Details Schema Diagram

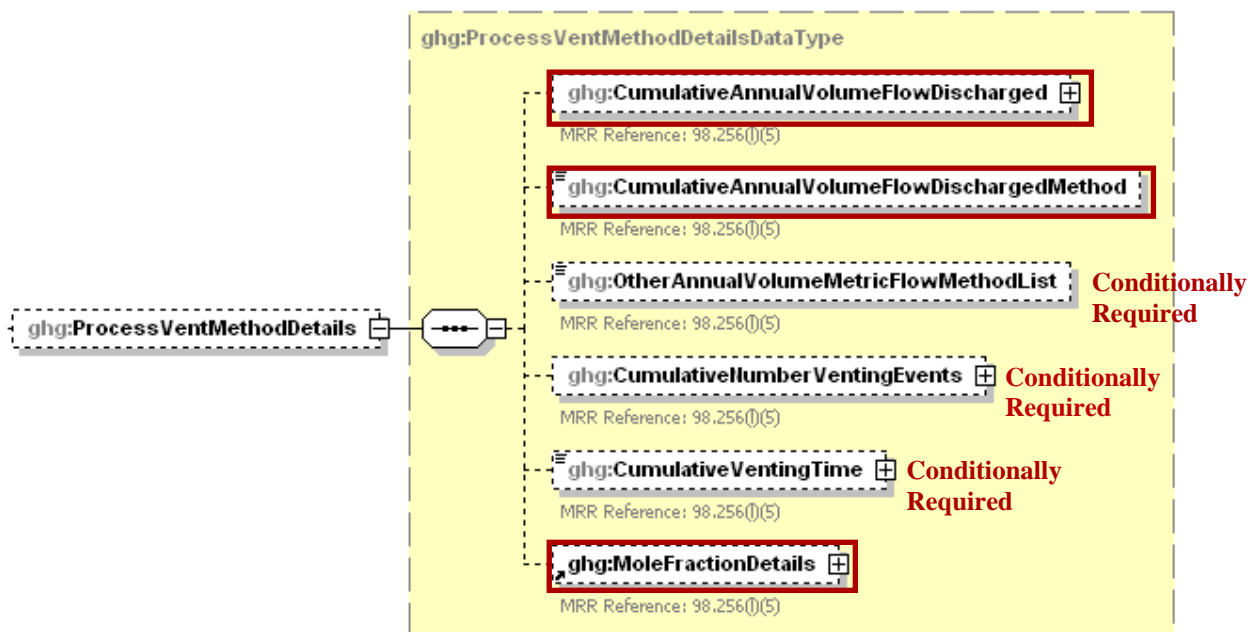

Note: Data elements boxed in red are required. Please see page 4 of this document for more information on conditionally required elements.

Conditionally Required: If the Process Vent method was used to calculate CO₂ emissions, then report the following:

- Annual volumetric flow discharged to the atmosphere (scf).
- Method used to measure or estimate the annual volumetric flow rate.
 - Continuous or at least hourly measurements
 - Routine (less frequent than hourly but at least weekly) measurements
 - Periodic (less frequent than weekly) measurements
 - Process knowledge
 - Engineering calculation
 - Other (specify)
- **Conditionally Required:** Number of venting events, if vent is intermittent.
- **Conditionally Required:** Cumulative venting time, if vent is intermittent (hours).
- CO₂ mole fraction details. (See [Mole Fraction Details Schema Diagram](#).)

Table 25
Process Vent Method Details Data Element Definitions

Data Element Name	Description
ProcessVentMethodDetails	Parent Element (Conditionally Required)
CumulativeAnnualVolumeFlowDischarged	The cumulative annual volumetric flow discharged to the atmosphere. Report the value in the child data element MeasureValue . Set the units of measure to “scf” in the attribute volUOM . [98.256(1)(5)]

Data Element Name	Description
CumulativeAnnualVolumeFlowDischargedMethod	<p>The method used to measure or estimate the annual volumetric flow discharged to the atmosphere. Below is the list of allowable values. [98.256(l)(5)]</p> <ul style="list-style-type: none"> Continuous or at least hourly measurements Routine (less frequent than hourly but at least weekly) measurements Periodic (less frequent than weekly) measurements Process knowledge Engineering calculation Other (specify)
OtherAnnualVolumeMetricFlowMethodList	<p>Conditionally Required: Specify the method used to measure or estimate the annual volumetric flow discharged to the atmosphere if not listed above. [98.256(l)(5)]</p>
CumulativeNumberVentingEvents	<p>Conditionally Required: The number of cumulative venting events for all relevant vents, if vents are intermittent (not applicable for continuous venting). Report the integer value in the child data element MeasureValue. [98.256(l)(5)]</p>
CumulativeVentingTime	<p>Conditionally Required: The cumulative venting time in hours for all intermittent vents. Set the units of measure to “Hours” in the attribute timeUOM. [98.256(l)(5)]</p>

XML Excerpt 21 Example for Process Vent Method Details

```

<ghg:ProcessVentMethodDetails>
  <ghg:CumulativeAnnualVolumeFlowDischarged volUOM="scf">
    <ghg:MeasureValue>123.23145</ghg:MeasureValue>
  </ghg:CumulativeAnnualVolumeFlowDischarged>
  <ghg:CumulativeAnnualVolumeFlowDischargedMethod>Process
knowledge</ghg:CumulativeAnnualVolumeFlowDischargedMethod>
  <ghg:CumulativeNumberVentingEvents>
    <ghg:MeasureValue>25</ghg:MeasureValue>
  </ghg:CumulativeNumberVentingEvents>
  <ghg:CumulativeVentingTime timeUOM="Hours">187</ghg:CumulativeVentingTime>

```

Note: The XML example above is presented here to demonstrate the concept of reporting details for the process vent method if used to calculate CO₂ emissions for the sulfur recovery plant.

**Figure 28
Mole Fraction Details Schema Diagram**



Note: Data elements boxed in red are required. Please see page 4 of this document for more information on conditionally required elements.

If the Process Vent method was used to calculate CO₂ emissions, then report the following:

- Annual average mole fraction of CO₂.
- Method used to measure or estimate the annual average mole fraction of CO₂.
 - Engineering estimates/process knowledge
 - Direct measurement
 - Other (specify)

Table 26
Mole Fraction Details Data Element Definitions

Data Element Name	Description
MoleFractionDetails	Parent Element
CO2AnnualAverageMoleFraction	Report the annual average mole fraction of CO ₂ . Report the value in the child data element MeasureValue . Set the units of measure to “fraction (number between 0 and 1)” in the attribute fractionUOM . [98.256(1)(5)]
CO2AnnualAverageMoleFractionMethod	Report the method used to measure or estimate the mole fraction of CO ₂ . [98.256(1)(5)] Below is the list of allowable values. Engineering estimates/process knowledge Direct measurement Other (specify)
OtherCO2AnnualAverageMoleFractionMethod	Conditionally Required: Specify the method used to measure or estimate the mole fraction of CO ₂ if not referenced above. [98.256(1)(5)]

XML Excerpt 22
Example for Mole Fraction Details

```

<ghg:MoleFractionDetails>
  <ghg:CO2AnnualAverageMoleFraction fractionUOM="fraction (number between 0 and 1)">
    <ghg:MeasureValue>0.5</ghg:MeasureValue>
  </ghg:CO2AnnualAverageMoleFraction>
  <ghg:CO2AnnualAverageMoleFractionMethod>Direct measurement</ghg:CO2AnnualAverageMoleFractionMethod>
</ghg:MoleFractionDetails>
</ghg:ProcessVentMethodDetails>

```

Note: The XML example above is presented here to demonstrate the concept of reporting the CO₂ mole fraction details.

Figure 29
Equation Y-12 Details Schema Diagram

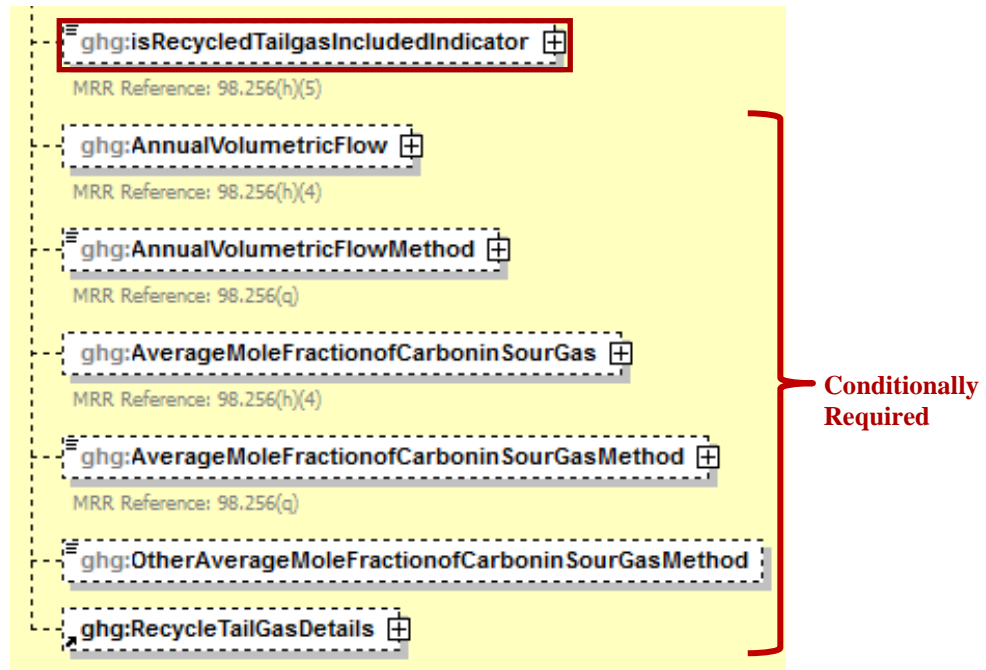

Note: Data elements boxed in red are required. Please see page 4 of this document for more information on conditionally required elements.

Conditionally Required: If Equation Y-12 is used to calculate CO₂ emissions, then the following information is required:

- An indication that if you recycle tail gas to the front of the plant, the recycled flow rate and carbon content of recycled tail gas are included in the measured volumetric flow and carbon mole fraction data. (If you do not recycle tail gas, please report “N”).
- **Conditionally Required:** If measured, report the following:
 - The number of hours that missing data procedures were used to determine the annual volume of sour gas fed to the sulfur recovery plant.
 - One or more methods used to estimate the annual volume of sour gas fed to the sulfur recovery plant.
 - The number of hours that missing data procedures were used to determine the annual average mole fraction of carbon in the sour gas.
 - The method used to estimate the annual average mole fraction of carbon in the sour gas.

Note: The above data collection elements are not required if you use a non-measurement option provided in the rule to report this data (i.e. engineering estimates).

Table 27
Equation Y-12 Details Data Element Definitions

Data Element Name	Description
isRecycledTailgasIncludedIndicator	For each plant using the Equation Y-12 calculation method, an indication that if you recycle tail gas to the front of the plant, the recycled flow rate and carbon content of recycled tail gas are included in the measured volumetric flow and carbon mole fraction data. (If you do not recycle tail gas, please report "N"). [98.256(h)(5)]
AnnualVolumetricFlow	Conditionally Required: For each plant using the Equation Y-12 calculation method, if measured, report the number of hours that missing data procedures were used to determine the annual volume of sour gas fed to the sulfur recovery plant in the child data element NumberOfTimesSubstituted . [98.3(c)(8), 98.256(h)(4)]
AnnualVolumetricFlowMethod	Conditionally Required: For each plant using the Equation Y-12 calculation method, if measured, report one or more methods used to estimate the annual volume of sour gas fed to the sulfur recovery plant. [98.256(q)]
AverageMoleFractionofCarboninSourGas	Conditionally Required: For each plant using the Equation Y-12 calculation method, if measured, report the number of hours that missing data procedures were used to determine the annual average mole fraction of carbon in the sour gas in the child data element NumberOfTimesSubstituted . [98.3(c)(8), 98.256(q)]
AverageMoleFractionofCarboninSourGasMethod	Conditionally Required: For each plant using the Equation Y-12 calculation method, if measured, report the method used to estimate the annual average mole fraction of carbon in the sour gas. Below is the list of allowable values. [98.256(q)] Method 18 at 40 CFR part 60, appendix A-6 ASTM D1945-03 ASTM D1946-90 (Reapproved 2006) GPA 2261-00 UOP539-97 ASTM D2503-92 (Reapproved 2007) Chromatographic analysis: manufacturer's instructions Other (specify)
OtherAverageMoleFractionofCarboninSourGasMethod	Conditionally Required: Method used to measure the annual average mole fraction of carbon in the sour gas if not listed above.

XML Excerpt 23 Example for Equation Y-12 Details

```

<ghg:isRecycledTailgasIncludedIndicator>Y</ghg:isRecycledTailgasIncludedIndicator>
<ghg:AnnualVolumetricFlow">
  <ghg:NumberOfTimesSubstituted>51</ghg:NumberOfTimesSubstituted>
</ghg:AnnualVolumetricFlow>
<ghg:AnnualVolumetricFlowMethod>Method A</ghg:AnnualVolumetricFlowMethod>
<ghg:AverageMoleFractionofCarboninSourGas>
  <ghg:NumberOfTimesSubstituted>15</ghg:NumberOfTimesSubstituted>
</ghg:AverageMoleFractionofCarboninSourGas>
<ghg:AverageMoleFractionofCarboninSourGasMethod>ASTM D1946-90 (Reapproved
2006</ghg:AverageMoleFractionofCarboninSourGasMethod>
    
```

Note: The XML example above is presented here to demonstrate the concept of reporting details for sulfur recovery plant units using Equation Y-12.

Figure 30 Recycle Tail Gas (Equation Y-12 Method) Details Schema Diagram

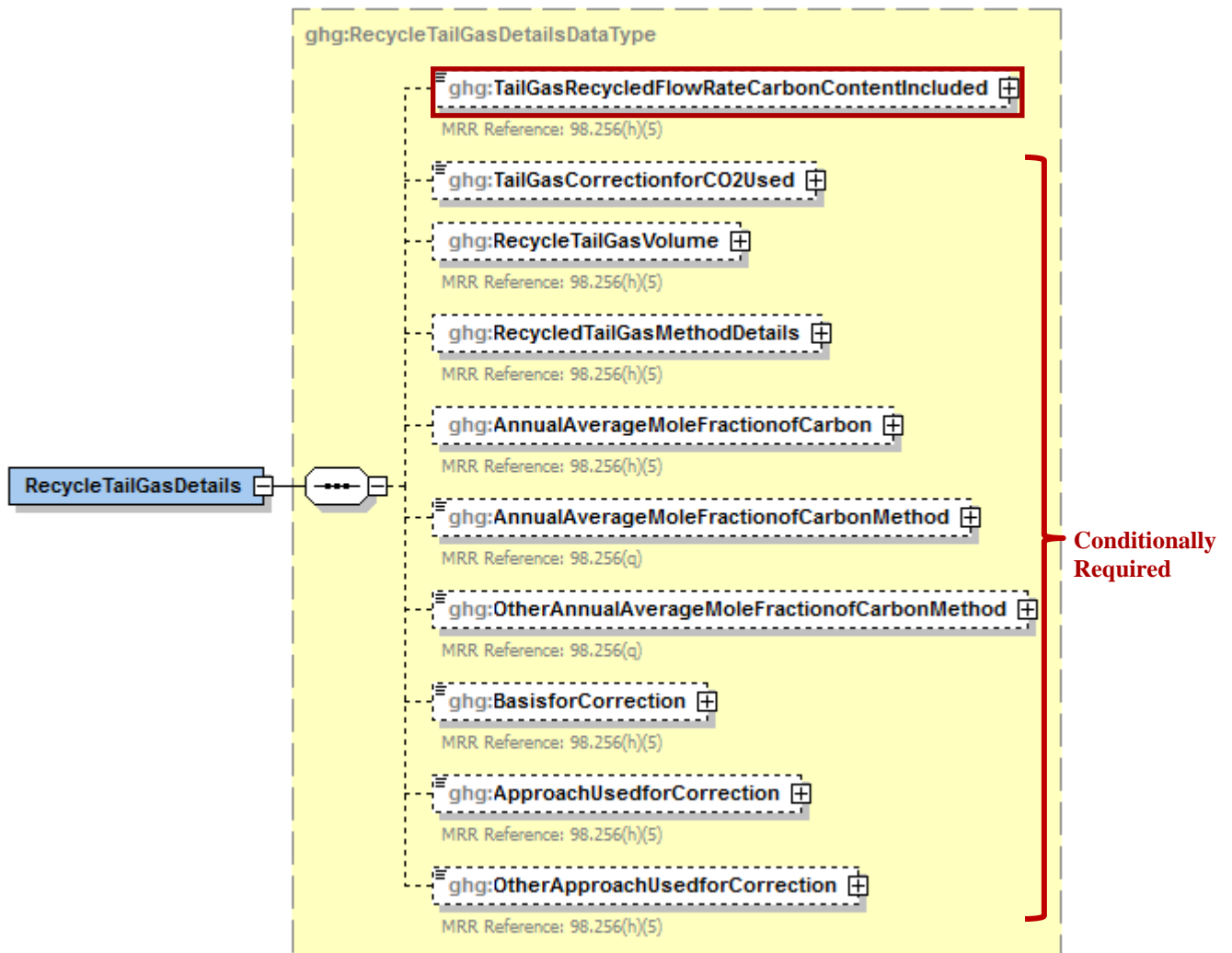

Note: Data elements boxed in red are required. Please see page 4 of this document for more information on conditionally required elements.

Conditionally Required: If Equation Y-12 is used to calculate CO₂ emissions, report the following information:

- An indication that if you recycle tail gas to the front of the plant, the recycled flow rate and carbon content of recycled tail gas are included in the measured volumetric flow and carbon mole fraction data. (If you do not recycle tail gas, please report “N”). **Note:** This is the same indicator as used for the data element “isRecycledTailgasIncludedIndicator”.
- **Conditionally Required:** If you indicated that you recycle tail gas to the front of the plant and the recycled flow rate and carbon content of recycled tail gas are included in the measured volumetric flow and carbon mole fraction data, indicate whether a correction for CO₂ emissions in the tail gas is used for Equation Y-12. **Note:** Per Section 98.253(f)(5), if tail gas is recycled to the front of the sulfur recovery plant and the recycled flow rate and carbon content are included in the measured data, then the annual CO₂ emissions must be corrected to avoid double counting these emissions.

Conditionally Required: If a correction for CO₂ emissions in the tail gas is used for Equation Y-12, report the following information:

- **Conditionally Required:** Annual volume of recycled tail gas (report only if the default correction factor was used and this value was not used to calculate the correction factor, in scf).
- **Conditionally Required:** If measured, the number of hours missing data procedures were used for annual volume of recycled tail gas.
- **Conditionally Required:** If measured, the method used to estimate the annual volume of recycled tail gas.
- **Conditionally Required:** Annual average mole fraction of carbon in the tail gas (report only if the default correction factor was used and this value was not used to calculate the correction factor, in kg-mole C/kg-mole gas).
- **Conditionally Required:** If measured, the number of hours missing data procedures were used for annual average mole fraction of carbon in the tail gas.
- **Conditionally Required:** If measured, the method used to estimate the annual average mole fraction of carbon in the tail gas.

Note: Data collection elements that contains the phrase "If measured" above are not required if you use a non-measurement option provided in the rule to report this data (i.e. engineering estimates).

- An indication of whether the default correction factor or a unit-specific correction factor was used.
- **Conditionally Required:** If a unit-specific correction factor was used, the method used to determine the correction factor used to calculate the CO₂ emissions:
 - Used measurement data for the annual volume of recycled tail gas and annual average mole fraction of carbon in the tail gas
 - Used measurement data for the annual volume of recycled tail gas and engineering calculations for mole fraction of carbon in the tail gas

- Used measurement data for the mole fraction of carbon in the tail gas and engineering calculations for the annual volume of recycled tail gas
- Used engineering calculations for both the annual volume of recycled tail gas and annual average mole fraction of carbon in the tail gas
- Other (specify)

**Table 28
Recycle Tail Gas Details Data Element Definitions**

Data Element Name	Description
RecycleTailGasDetails	Parent Element (Conditionally Required)
TailGasRecycledFlowRateCarbonContentIncluded	For each plant using the Equation Y-12 calculation method, an indication that if you recycle tail gas to the front of the plant, the recycled flow rate and carbon content of recycled tail gas are included in the measured volumetric flow and carbon mole fraction data. (If you do not recycle tail gas, please report “N”). [98.256(h)(5)]
TailGasCorrectionforCO2Used	Conditionally Required: If you indicated that you recycle tail gas to the front of the plant and the recycled flow rate and carbon content of recycled tail gas are included in the measured volumetric flow and carbon mole fraction data, indicate (Y/N) whether a correction for CO ₂ emissions in the tail gas is used for Equation Y-12. [98.256(h)(5)]
RecycleTailGasVolume	<p>Conditionally Required: For each plant using the Equation Y-12 calculation method that also recycles tail gas to the front of the plant and that also includes a tail gas correction, report the annual volume of recycled tail gas (report only if the default correction factor was used and this value was not used to calculate the correction factor). Report the value in the child data element MeasureValue. Set the units of measure to “scf” in the attribute volUOM. [98.256(h)(5)]</p> <p>Conditionally Required: For each plant using the Equation Y-12 calculation method that also recycles tail gas to the front of the plant and that also includes a tail gas correction, if measured, report the number of hours that missing data procedures were used in determining the annual volume of recycled tail gas in the child data element NumberOfTimesSubstituted. [98.3(c)(8), 98.256(h)(5)]</p>
RecycledTailGasMethodDetails	Parent Element (Conditionally Required)

Data Element Name	Description
RecycledTailGasMethod	<p>For each plant using the Equation Y-12 calculation method that also recycles tail gas to the front of the plant and that also includes a tail gas correction, if measured, the method used to estimate the annual volume of recycled tail gas. Below is the list of allowable values. [98.256(q)]</p> <ul style="list-style-type: none"> Consensus based standard method Procedures specified by manufacturer Engineering estimates Company records Other (specify)
OtherRecycledTailGasMethod	<p>Conditionally Required: Specify the method used to measure the annual volume of recycled tail gas if “Consensus based standard method”, “Procedures specified by manufacturer” or “Other (specify)” was reported above.</p>
AnnualAverageMoleFractionofCarbon	<p>Conditionally Required: For each plant using the Equation Y-12 calculation method that also recycles tail gas to the front of the plant and that also includes a tail gas correction, report the annual average mole fraction of carbon in the tail gas (report only if the default correction factor was used and this value was not used to calculate the correction factor). Report the value in the child data element MeasureValue. Set the units of measure to “kg-mole C/kg-molegas” in the attribute fractionUOM. [98.256(h)(5)]</p> <p>Conditionally Required: For each plant using the Equation Y-12 calculation method that also recycles tail gas to the front of the plant and that also includes a tail gas correction, if measured, report the number of hours that missing data procedures were used in determining the annual average mole fraction of carbon in the tail gas, if measured in the child data element NumberofTimesSubstituted. Set the units of measure to “kg-mole C/kg-molegas” in the attribute fractionUOM. Note: Although the measured value of the annual average mole fraction of carbon in the tail gas may not be required, the attribute fractionUOM is required by the schema and must be reported if AnnualAverageMoleFractionofCarbon is reported. [98.3(c)(8), [98.256(h)(5)]</p>
AnnualAverageMoleFractionofCarbonMethod	<p>Conditionally Required: For each plant using the Equation Y-12 calculation method that also recycles tail gas to the front of the plant and that also includes a tail gas correction, if measured, report the method used to measure the annual average mole fraction of carbon in the tail gas. Below is the list of allowable values. [98.256(q)]</p> <ul style="list-style-type: none"> Continuous composition monitor Routine (daily, weekly, or monthly) measurements Limited measurement data Engineering calculations Default value Other (specify)

Data Element Name	Description
OtherAnnualAverageMoleFractionofCarbonMethod	<p>Conditionally Required: Specify the method used to measure the annual average mole fraction of carbon in the tail gas if not listed above.</p>
BasisforCorrection	<p>Conditionally Required: For each plant using the Equation Y-12 calculation method that also recycles tail gas to the front of the plant and that also includes a tail gas correction, indicate whether you used the default (95%) or a unit specific correction factor. [98.256(h)(5)] Below is the list of allowable values.</p> <ul style="list-style-type: none"> Default correction factor (95%) Unit-specific correction factor
ApproachUsedforCorrection	<p>Conditionally Required: For each plant using the Equation Y-12 calculation method that also specifies use of a unit-specific correction for tail gas, the approach used to determine the correction factor used to calculate the CO₂ emissions. Below is the list of allowable values. [98.256(q)]</p> <ul style="list-style-type: none"> Used measurement data for the annual volume of recycled tail gas and annual average mole fraction of carbon in the tail gas Used measurement data for the annual volume of recycled tail gas and engineering calculations for mole fraction of carbon in the tail gas Used measurement data for the mole fraction of carbon in the tail gas and engineering calculations for the annual volume of recycled tail gas Used engineering calculations for both the annual volume of recycled tail gas and annual average mole fraction of carbon in the tail gas Other (specify)
OtherApproachUsedforCorrection	<p>Conditionally Required: Specify the approach used to determine correction factor used to calculate the CO₂ emissions if not listed above.</p>

XML Excerpt 24 Example for Recycled Tail Gas Details (Default Correction Factor)

```
<ghg:RecycleTailGasDetails>
  <ghg:TailGasRecycledFlowRateCarbonContentIncluded>Y</ghg:TailGasRecycledFlowRateCarbonContentIncluded>
  <ghg:TailGasCorrectionforCO2Used>Y</ghg:TailGasCorrectionforCO2Used>
  <ghg:RecycleTailGasVolume volUOM="scf">
    <ghg:MeasureValue>342.2364</ghg:MeasureValue>
    <ghg:NumberofTimesSubstituted>147</ghg:NumberofTimesSubstituted>
  </ghg:RecycleTailGasVolume>
  <ghg:RecycledTailGasMethodDetails>
    <ghg:RecycledTailGasMethod>Engineering estimates</ghg:RecycledTailGasMethod>
  </ghg:RecycledTailGasMethodDetails>
  <ghg:AnnualAverageMoleFractionofCarbon fractionUOM="kg-mole C/kg-molegas">
    <ghg:MeasureValue>0.454</ghg:MeasureValue>
    <ghg:NumberofTimesSubstituted>123</ghg:NumberofTimesSubstituted>
  </ghg:AnnualAverageMoleFractionofCarbon>
  <ghg:AnnualAverageMoleFractionofCarbonMethod>Engineering
  calculations</ghg:AnnualAverageMoleFractionofCarbonMethod>
  <ghg:BasisforCorrection>Default correction factor (95%)</ghg:BasisforCorrection>
</ghg:RecycleTailGasDetails>
```

Note: The XML example above is presented here to demonstrate the concept of reporting details for the recycled tail gas if Equation Y-12 and the default correction factor were used to calculate CO₂ emissions for the sulfur recovery plant.

XML Excerpt 25 Example for Recycled Tail Gas Details (Unit-Specific Correction Factor)

```
<ghg:RecycleTailGasDetails>
  <ghg:TailGasRecycledFlowRateCarbonContentIncluded>Y</ghg:TailGasRecycledFlowRateCarbonContentIncluded>
  <ghg:TailGasCorrectionforCO2Used>Y</ghg:TailGasCorrectionforCO2Used>
  <ghg:RecycleTailGasVolume>
    <ghg:NumberofTimesSubstituted>147</ghg:NumberofTimesSubstituted>
  </ghg:RecycleTailGasVolume>
  <ghg:RecycledTailGasMethodDetails>
    <ghg:RecycledTailGasMethod>Engineering estimates</ghg:RecycledTailGasMethod>
  </ghg:RecycledTailGasMethodDetails>
  <ghg:AnnualAverageMoleFractionofCarbon fractionUOM="kg-mole C/kg-molegas">
    <ghg:NumberofTimesSubstituted>123</ghg:NumberofTimesSubstituted>
  </ghg:AnnualAverageMoleFractionofCarbon>
  <ghg:AnnualAverageMoleFractionofCarbonMethod>Engineering
  calculations</ghg:AnnualAverageMoleFractionofCarbonMethod>
  <ghg:BasisforCorrection>Unit-specific correction factor</ghg:BasisforCorrection>
  <ghg:ApproachUsedforCorrection>Used measurement data for the annual volume of recycled tail gas and annual average
  mole fraction of carbon in the tail gas</ghg:ApproachUsedforCorrection>
</ghg:RecycleTailGasDetails>
```

Note: The XML example above is presented here to demonstrate the concept of reporting details for the recycled tail gas if Equation Y-12 and a unit-specific correction factor were used to calculate CO₂ emissions for the sulfur recovery plant.

4.3 Sulfur Recovery CEMS Details

Conditionally Required Unit-Level Data

For each sulfur recovery unit that is monitored with a CEMS to measure CO₂ emissions, according to the guidelines specified in Subpart C, report the unit’s identification information and the relevant information required under 98.36 for the Tier 4 Calculation Methodology. See instructions for reporting parent element “[YTier4CEMSDetails](#).” **Note:** Use the same identification for the unit as was used for the parent element “SulfurRecoveryUnitDetails”.

Figure 31
Sulfur Recovery Unit CEMS Details Schema Diagram

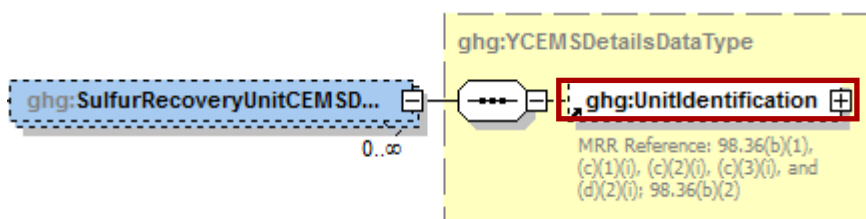

Note: Data elements boxed in red are required.

Table 29
Sulfur Recovery Unit CEMS Details Data Element Definitions

Data Element Name	Description
SulfurRecoveryUnitCEMSDetails	Parent Element
UnitIdentification	<p>A collection of data elements containing the identity of each CEMS sulfur recovery plant unit. Report a unique unit name (ID) in the child data element UnitName, an optional brief description in the child data element UnitDescription and the type of unit in the child data element UnitType. Report the following unit type:</p> <p>Sulfur Recovery Plant</p> <p>Note: Use the same identification for the unit as was used for the parent element “SulfurRecoveryUnitDetails”.</p>

XML Excerpt 26
Example for Sulfur Recovery Unit CEMS Details

```
<ghg:SulfurRecoveryUnitCEMSDetails>
  <ghg:UnitIdentification>
    <ghg:UnitName>SRP-001</ghg:UnitName>
    <ghg:UnitType>Sulfur Recovery Plant</ghg:UnitType>
  </ghg:UnitIdentification>
</ghg:SulfurRecoveryUnitCEMSDetails>
```

Note: The XML example above is presented here to demonstrate the concept of reporting unit identification for a sulfur recovery plant monitored by CEMS.

5.0 Coke Calcining Unit Information

Conditionally Required Unit-Level Data

This topic provides a step-by-step description of how to report Subpart Y Coke Calcining unit information for your facility.

5.1 Coke Calcining Unit Details

You are required to report CO₂, CH₄ and N₂O emissions from each coke calcining unit under this Subpart.

Figure 32
Coke Calcining Unit Details Schema Diagram

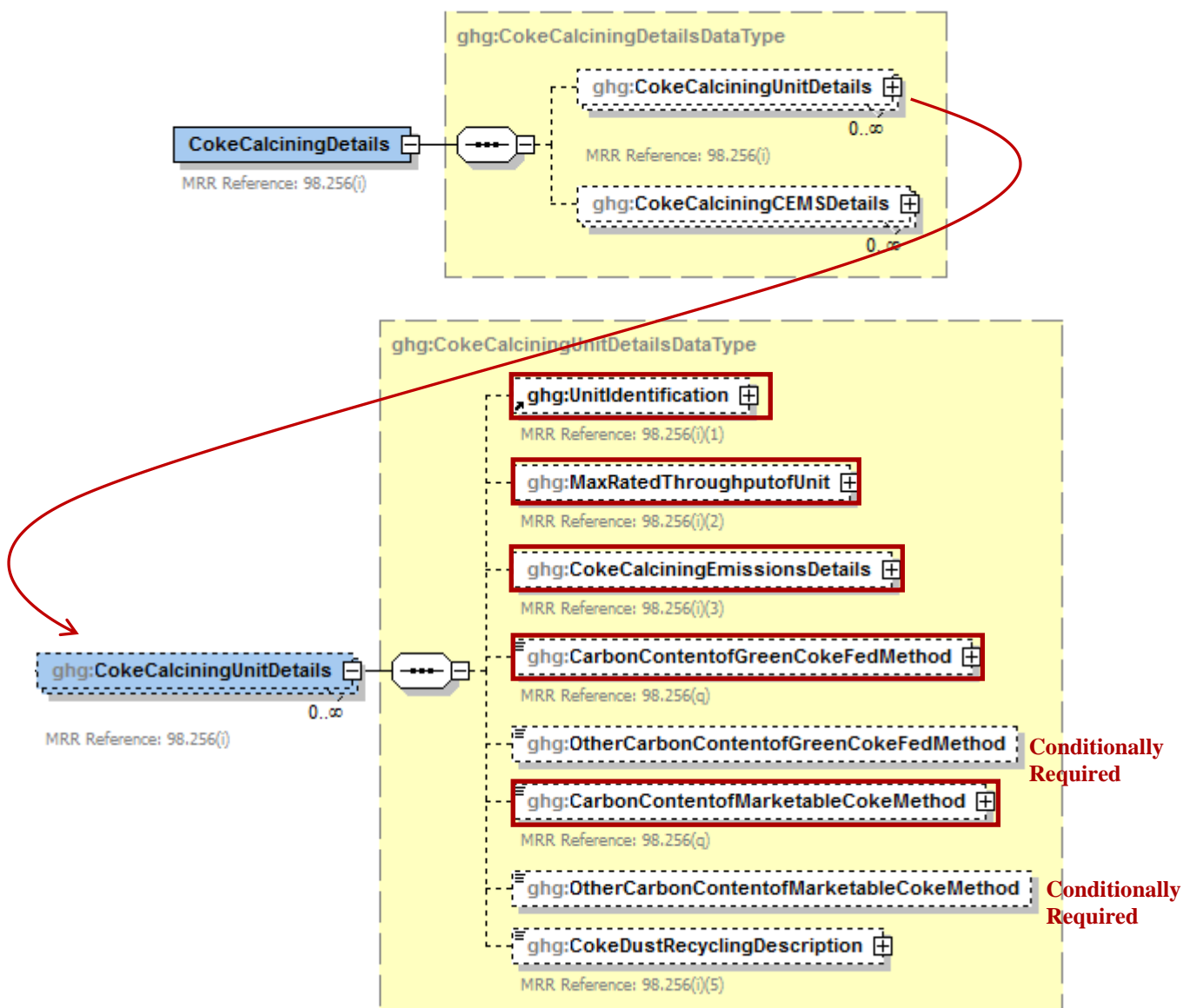

Note: Data elements boxed in red are required. Please see page 4 of this document for more information on conditionally required elements.

You are required to report the following data about each coke calcining unit:

- A unique name or identifier, plus optional description for each coke calcining unit. See also [About Unique Unit Names](#).
- Maximum rated throughput of the coke calcining unit (metric tons coke calcined per stream day)

**Table 30
Coke Calcining Unit Details Data Element Definitions**

Data Element Name	Description
CokeCalciningDetails	Parent Element (Conditionally Required)
CokeCalciningUnitDetails	Parent Element
UnitIdentification	<p>A collection of data elements containing the identity of each coke calcining unit. Report a unique unit name (ID) in the child data element UnitName, an optional brief description in the child data element UnitDescription and the type of unit in the child data element UnitType. [98.256(i)(1)] Report the following unit type:</p> <p>Coke Calcining Unit</p>
MaxRatedThroughputofUnit	<p>Maximum rated throughput of the specified coke calcining unit (metric tons coke calcined per stream day). Report the value in the child data element MeasureValue. Set the units of measure to “metric tons/streamday” in the attribute rateUOM. [98.256(i)(2)]</p>

**XML Excerpt 27
Example for Coke Calcining Unit Details**

```

<ghg:CokeCalciningUnitDetails>
  <ghg:UnitIdentification>
    <ghg:UnitName>CC-001</ghg:UnitName>
    <ghg:UnitType>Coke Calcining Unit</ghg:UnitType>
  </ghg:UnitIdentification>
  <ghg:MaxRatedThroughputofUnit rateUOM="metric tons/streamday">
    <ghg:MeasureValue>232</ghg:MeasureValue>
  </ghg:MaxRatedThroughputofUnit>

```

Note: The XML example above is presented here to demonstrate the concept of reporting details for coke calcining units.

Figure 33
Coke Calcining Emissions Details Schema Diagram

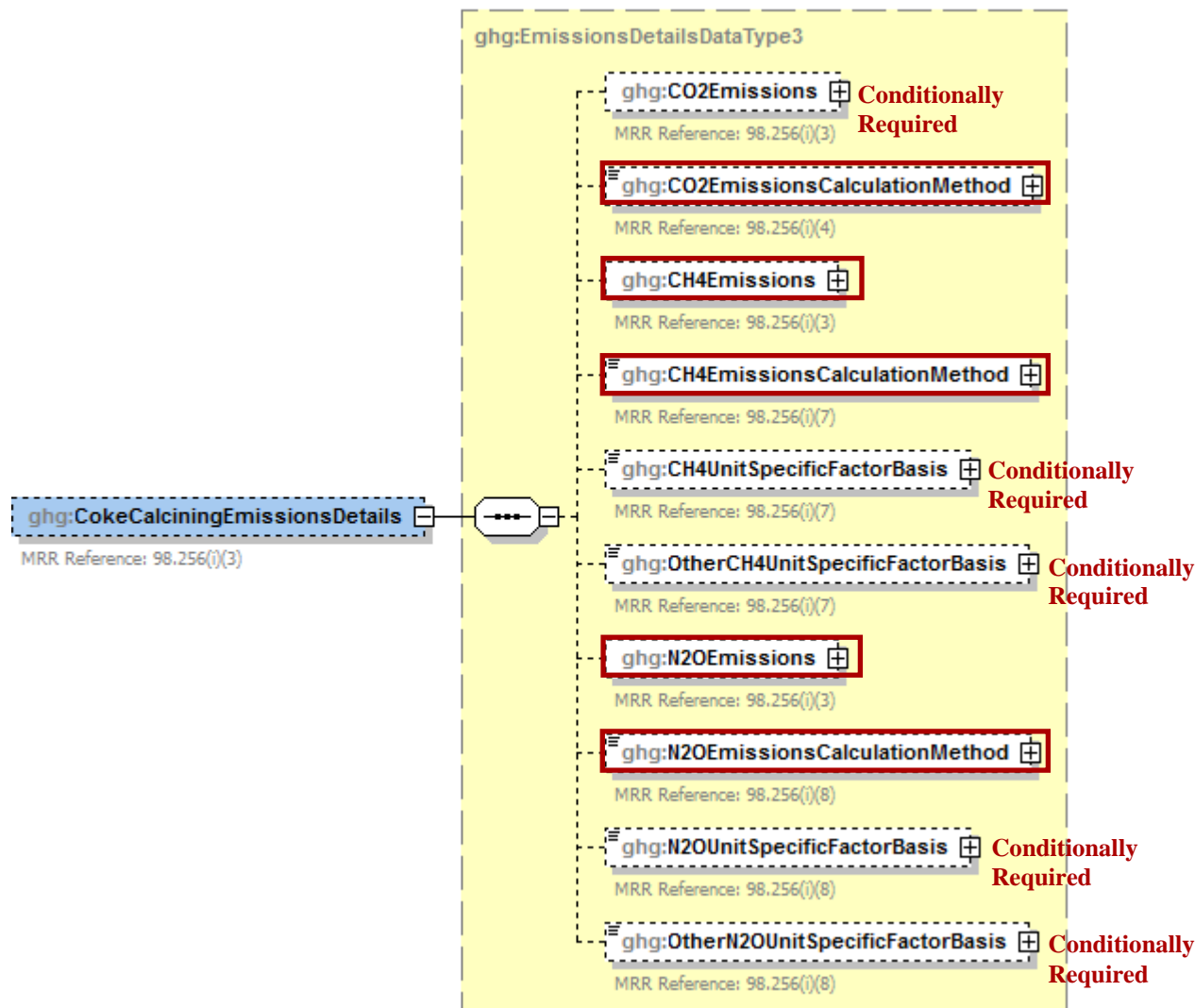

Note: Data elements boxed in red are required. Please see page 4 of this document for more information on conditionally required elements.

Subpart Y collects the following data about your coke calcining unit emissions:

- **Conditionally Required:** The calculated CO₂ annual emissions for each unit not monitored by a CEMS, expressed in metric tons. To calculate the annual CO₂ emissions rate, use Equation Y-13.
- An indication of the method used to calculate CO₂ annual emissions for each coke calcining unit.
- The calculated CH₄ and N₂O annual emissions for each unit, expressed in metric tons of each GHG emitted.
- The calculation method used to calculate CH₄ and N₂O annual emissions for each unit.

- **Conditionally Required:** Basis for the unit-specific emission factors used to calculate CH₄ and N₂O emissions. (Report this value only if you used a unit-specific emission factor based on a source test result.)
 - Weekly or more frequent measurements
 - Periodic (less frequent than weekly) measurements
 - Average of multiple source tests
 - One-time source test
 - Other

**Table 31
Coke Calcining Emissions Details Data Element Definitions**

Data Element Name	Description
CokeCalciningEmissionsDetails	Parent Element
CO2Emissions	Conditionally Required: The calculated CO ₂ annual emissions for the specified coke calcining unit if not monitored by a CEMS. Report the value in the child data element CalculatedValue . Set the units of measure to “Metric Tons” in the attribute massUOM . [98.256(i)(3)]
CO2EmissionsCalculationMethod	The method used to calculate the CO ₂ emissions for the specified coke calcining unit. [98.256(i)(4)] Below is the list of allowable values. CO2 CEMS Equation Y-13
CH4Emissions	The calculated CH ₄ annual emissions for the specified coke calcining unit. Report the value in the child data element CalculatedValue . Set the units of measure to “Metric Tons” in the attribute massUOM . [98.256(i)(3)]
CH4EmissionsCalculationMethod	The method used to calculate the CH ₄ emissions for the specified coke calcining unit. [98.256(i)(7)] Below is the list of allowable values. Unit-specific measurement data Unit-specific emissions factor based on a source test of the unit Equation Y-9 with a default emission factor
CH4UnitSpecificFactorBasis	Conditionally Required: The basis for the unit-specific emission factor used to determine CH ₄ annual emissions if the emission factor was based on a source test of the unit. [98.256(i)(7)] Below is the list of allowable values. Weekly or more frequent measurements Periodic (less frequent than weekly) measurements Average of multiple source tests One-time source test Other (specify)

Data Element Name	Description
OtherCH4UnitSpecificFactorBasis	Conditionally Required: Specify the basis for the unit-specific emission factor used to determine CH ₄ emissions if not referenced in the list of allowable basis values. [98.256(i)(7)]
N2OEmissions	The calculated N ₂ O annual emissions for the specified coke calcining unit. Report the value in the child data element CalculatedValue . Set the units of measure to “Metric Tons” in the attribute massUOM . [98.256(i)(3)]
N2OEmissionsCalculationMethod	The method used to calculate the N ₂ O emissions for the specified coke calcining unit. [98.256(i)(8)] Below is the list of allowable values. Unit-specific measurement data Unit-specific emissions factor based on a source test of the unit Equation Y-10 with a default emission factor
N2OUnitSpecificFactorBasis	Conditionally Required: The basis for the unit-specific emission factor used to determine N ₂ O annual emissions if the emission factor was based on a source test of the unit. [98.256(i)(8)] Below is the list of allowable values. Weekly or more frequent measurements Periodic (less frequent than weekly) measurements Average of multiple source tests One-time source test Other (specify)
OtherN2OUnitSpecificFactorBasis	Conditionally Required: Specify the basis for the unit-specific emission factor used to determine N ₂ O emissions if not referenced in the list of allowable basis values. [98.256(i)(8)]

XML Excerpt 28 Example for Coke Calcining Emissions Details

```

<ghg:CokeCalciningEmissionsDetails>
  <ghg:CO2Emissions massUOM="Metric Tons">
    <ghg:CalculatedValue>22230.8</ghg:CalculatedValue>
  </ghg:CO2Emissions>
  <ghg:CO2EmissionsCalculationMethod>Equation Y-13</ghg:CO2EmissionsCalculationMethod>
  <ghg:CH4Emissions massUOM="Metric Tons">
    <ghg:CalculatedValue>4562.12</ghg:CalculatedValue>
  </ghg:CH4Emissions>
  <ghg:CH4EmissionsCalculationMethod>Equation Y-9 with a default emission factor</ghg:CH4EmissionsCalculationMethod>
  <ghg:N2OEmissions massUOM="Metric Tons">
    <ghg:CalculatedValue>8765.123</ghg:CalculatedValue>
  </ghg:N2OEmissions>
  <ghg:N2OEmissionsCalculationMethod> Unit-specific emission factor based on a source test of the
unit</ghg:N2OEmissionsCalculationMethod>
  <ghg:N2OUnitSpecificFactorBasis>One-time source test</ghg:N2OUnitSpecificFactorBasis>
</ghg:CokeCalciningEmissionsDetails>

```

Note: The XML example above is presented here to demonstrate the concept of reporting emissions details for coke calcining units.

Conditionally Required: The following information is required for each coke calcining unit using the Equation Y-13 calculation method (which is not monitored by a CEMS):

- Method used to measure the annual carbon content of green coke fed to the unit.
 - ASTM D3176-89-Reapproved 2002
 - ASTM D5291-02-Reapproved 2007
 - ASTM D5373-08

- Method used to measure the annual carbon content of marketable coke produced.
 - ASTM D3176-89-Reapproved 2002
 - ASTM D5291-02-Reapproved 2007
 - ASTM D5373-08

- Description of coke dust recycling for the unit.
 - All dust is recycled
 - A portion of the dust is recycled
 - None of the dust is recycled

**Table 32
Coke Calcining Unit Method Details Data Element Definitions**

Data Element Name	Description
CarbonContentofGreenCokeFedMethod	<p>Conditionally Required: If the unit used the Equation Y-13 calculation method, the method used to measure the annual carbon content of green coke fed to the unit. [98.256(q)] Below is the list of allowable values.</p> <p>ASTM D3176-89 (Reapproved 2002) ASTM D5291-02 (Reapproved 2007) ASTM D5373-08 Other (specify)</p>
OtherCarbonContentofGreenCokeFedMethod	<p>Conditionally Required: The method used to measure the annual carbon content of green coke fed to the unit if not listed above.</p>
CarbonContentofMarketableCokeMethod	<p>Conditionally Required: If the unit used the Equation Y-13 calculation method, the method used to measure the annual carbon content of marketable coke produced. [98.256(q)] Below is the list of allowable values.</p> <p>ASTM D3176-89 (Reapproved 2002) ASTM D5291-02 (Reapproved 2007) ASTM D5373-08 Other (specify)</p>
OtherCarbonContentofMarketableCokeMethod	<p>Conditionally Required: The method used to measure the annual carbon content of marketable coke produced if not listed above.</p>

Data Element Name	Description
CokeDustRecyclingDescription	<p>Conditionally Required: If the unit used the Equation Y-13 calculation method, a description of coke dust recycling for the unit. [98.256(i)(5)] Below is the list of allowable values.</p> <p>All dust is recycled A portion of the dust is recycled None of the dust is recycled</p>

XML Excerpt 29
Example for Coke Calcining Unit Method Details

```

<ghg:CarbonContentofGreenCokeFedMethod>ASTM D5373-08</ghg:CarbonContentofGreenCokeFedMethod>
<ghg:CarbonContentofMarketableCokeMethod> ASTM D5373-08</ghg:CarbonContentofMarketableCokeMethod>
<ghg:CokeDustRecyclingDescription>All dust is recycled</ghg:CokeDustRecyclingDescription>
</ghg:CokeCalciningUnitDetails>

```

Note: The XML example above is presented here to demonstrate the concept of reporting details for coke calcining units.

5.2 Coke Calcining CEMS Details

For each coke calcining unit that is monitored with a CEMS to measure CO₂ emissions according to the guidelines specified in Subpart C, report the unit’s identification information and the relevant information required under 98.36 for the Tier 4 Calculation Methodology. See instructions for reporting parent element “[YTier4CEMSDetails](#).”

Figure 34
Coke Calcining CEMS Details Schema Diagram

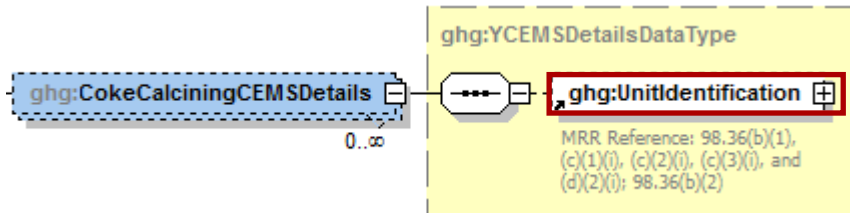

Note: Data elements boxed in red are required.

Table 33
Coke Calcining CEMS Details Data Element Definitions

Data Element Name	Description
CokeCalciningCEMSDetails	Parent Element
UnitIdentification	<p>A collection of data elements containing the identity of each CEMS coke calcining unit. Report a unique unit name (ID) in the child data element UnitName, an optional brief description in the child data element UnitDescription and the type of unit in the child data element UnitType. Report the following unit type:</p> <p>Coke Calcining Unit</p> <p>Note: Use the same identification for the unit as was used for the parent element “CokeCalciningUnitDetails”.</p>

XML Excerpt 30
Example for Coke Calcining CEMS Details

```

<ghg:CokeCalciningCEMSDetails>
  <ghg:UnitIdentification>
    <ghg:UnitName>CC-001</ghg:UnitName>
    <ghg:UnitType>Coke Calcining Unit</ghg:UnitType>
  </ghg:UnitIdentification>
</ghg:CokeCalciningCEMSDetails>
</ghg:CokeCalciningDetails>
    
```

Note: The XML example above is presented here to demonstrate the concept of reporting details for coke calcining units.

6.0 Asphalt Blowing Operations

Conditionally Required Unit-Level Data

This topic provides a step-by-step description of how to report Subpart Y asphalt blowing operations information for your facility. You are required to report CO₂ and CH₄ emissions from each asphalt blowing operations unit that is subject to this Subpart.

Figure 35
Asphalt Blowing Unit Details Schema Diagram

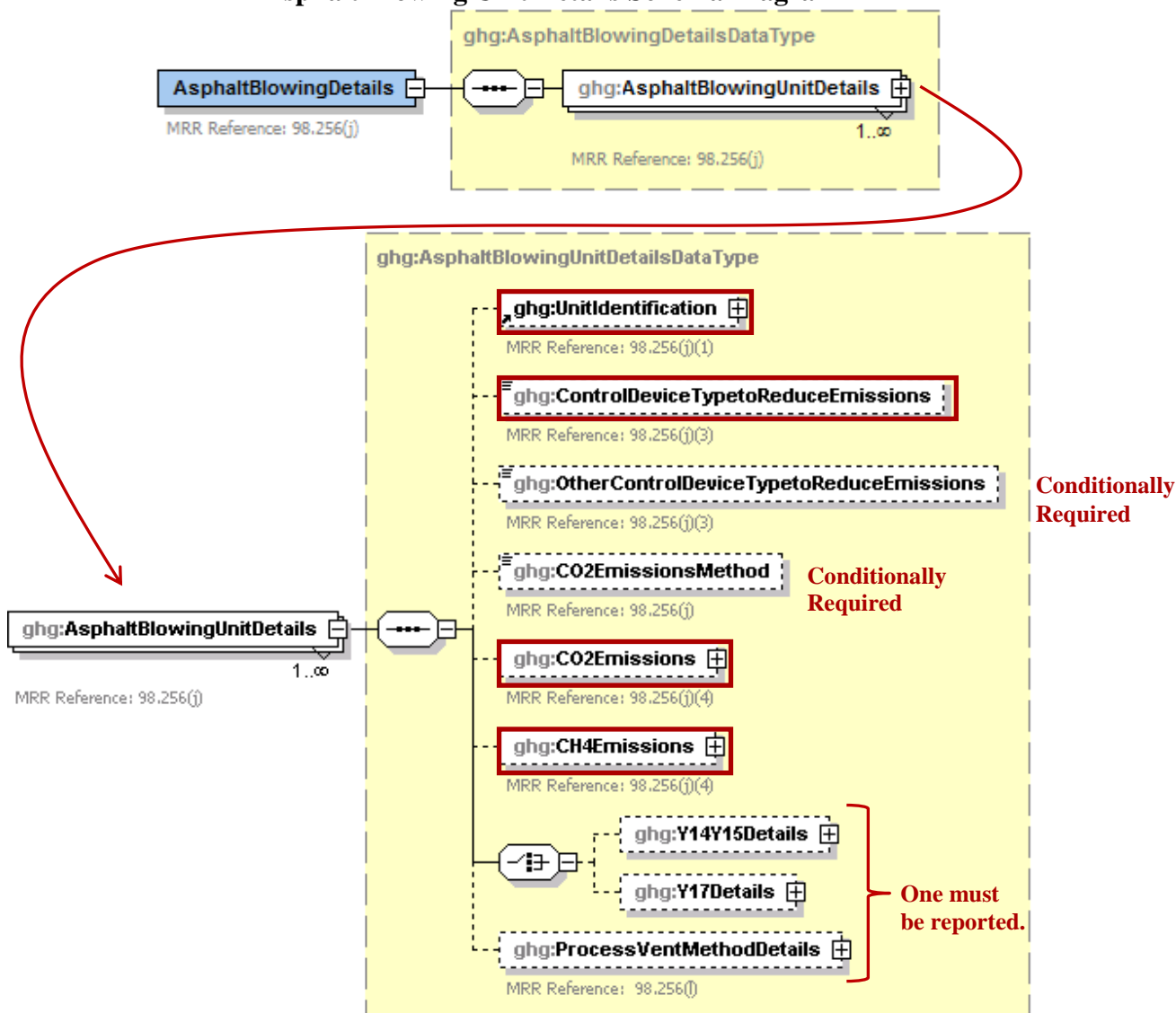

Note: Data elements boxed in red are required. Please see page 4 of this document for more information on conditionally required elements.

Subpart Y requires you to report the following data about your asphalt blowing operations:

- A unique name or identifier, plus optional description for each asphalt blowing unit.
- The control device used to reduce methane (and other organic) emissions from the unit.
 - Vapor scrubber

- Thermal oxidizer
- Flare
- Other (specify)
- None
- The method used to calculate the CO₂ emissions for your asphalt blowing operations.
 - Equations Y-14 and Y-15
 - Equations Y-16a and Y-17
 - Equations Y-16b and Y-17
 - Equation Y-19 (Process Vent)

Note: For uncontrolled asphalt blowing operations or for asphalt blowing operations controlled by vapor scrubbing, calculate CO₂ and CH₄ emissions using Equations Y-14 and Y-15, respectively. For asphalt blowing operations controlled by thermal oxidizer or flare, calculate CH₄ emissions using Equation Y-17 and calculate CO₂ emissions using either Equations Y-16a or Equation Y-16b, provided these emissions are not already included in the flare emissions calculated elsewhere in the XML file.

- The calculated CO₂ and CH₄ annual emissions for each asphalt blower unit, expressed in metric tons.

**Table 34
Asphalt Blowing Unit Details Data Element Definitions**

Data Element Name	Description
AsphaltBlowingDetails	Parent Element (Conditionally Required)
AsphaltBlowingUnitDetails	Parent Element
UnitIdentification	A collection of data elements containing the identity of each asphalt blowing operations unit. Report a unique unit name (ID) in the child data element UnitName , an optional brief description in the child data element UnitDescription and the type of unit in the child data element UnitType . [98.256(j)(1)] Report the following unit type: Asphalt Blowing Unit
ControlDeviceTypetoReduceEmissions	The type of control device used to reduce methane (and other organic) emissions from the unit. Below is the list of allowable values. [98.256(j)(3)] Vapor scrubber Thermal oxidizer Flare Other (specify) None
OtherControlDeviceTypetoReduceEmissions	Conditionally Required: Specify the type of control device used if not listed above. [98.256(j)(3)]

Data Element Name	Description
CO2EmissionsMethod	<p>The method used to calculate the CO₂ emissions for your asphalt blowing operations. [98.256(j)] Below is the list of allowable values.</p> <p>Equation Y-14 and Y-15 Equation Y-16a and Y-17 Equation Y-16b and Y-17 Equation Y-19 (Process Vent)</p>
CO2Emissions	<p>The calculated CO₂ annual emissions for each asphalt blowing unit. Report the value in the child data element CalculatedValue. Set the units of measure to “Metric Tons” in the attribute massUOM. [98.256(j)(4)]</p>
CH4Emissions	<p>The calculated CH₄ annual emissions for each asphalt blowing unit. Report the value in the child data element CalculatedValue. Set the units of measure to “Metric Tons” in the attribute massUOM. [98.256(j)(4)]</p>

XML Excerpt 31 Example for Asphalt Blowing Unit Details

```

<ghg:AsphaltBlowingDetails>
  <ghg:AsphaltBlowingUnitDetails>
    <ghg:UnitIdentification>
      <ghg:UnitName>ABO-001</ghg:UnitName>
      <ghg:UnitDescription>Bitumen blowing unit</ghg:UnitDescription>
      <ghg:UnitType>Asphalt Blowing Unit</ghg:UnitType>
    </ghg:UnitIdentification>
    <ghg:ControlDeviceTypeToReduceEmissions>Vapor scrubber</ghg:ControlDeviceTypeToReduceEmissions>
    <ghg:CO2EmissionsMethod>Equation Y-14 and Y-15</ghg:CO2EmissionsMethod>
    <ghg:CO2Emissions massUOM="Metric Tons">
      <ghg:CalculatedValue>3443.2</ghg:CalculatedValue>
    </ghg:CO2Emissions>
    <ghg:CH4Emissions massUOM="Metric Tons">
      <ghg:CalculatedValue>786.89</ghg:CalculatedValue>
    </ghg:CH4Emissions>
  </ghg:AsphaltBlowingUnitDetails>
</ghg:AsphaltBlowingDetails>

```

Note: The XML example above is presented here to demonstrate the concept of reporting emissions details for asphalt blowing units.

6.1 Equation Y-14 and Y-15 Details

Figure 36
Equations Y-14 and Y-15 Details Schema Diagram

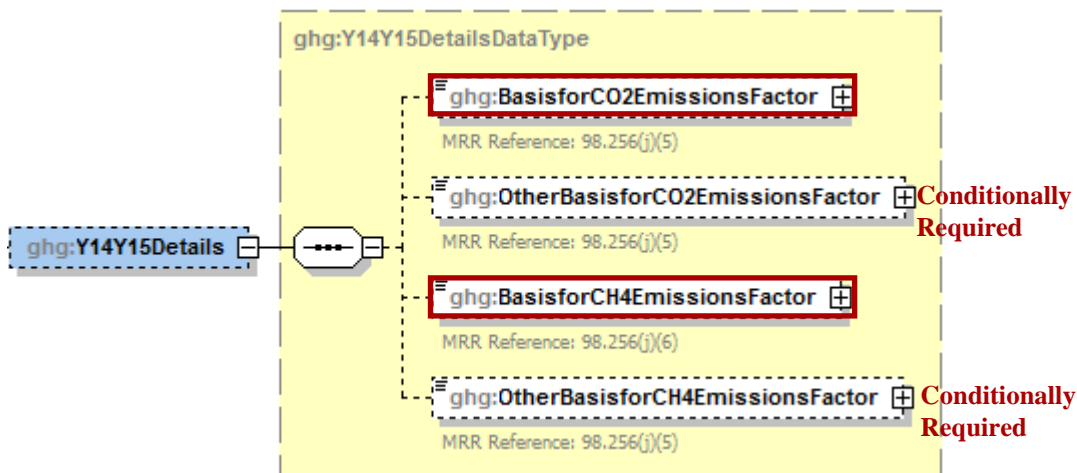

Note: Data elements boxed in red are required. Please see page 4 of this document for more information on conditionally required elements.

Conditionally Required: If you used Equation Y-14 and Y-15 to calculate CO₂ and CH₄ annual emissions for your asphalt blowing operation, then you must also report the basis for CO₂ and CH₄ emissions factors:

- Used default emission factor
- Weekly or more frequent measurements
- Periodic (less frequent than weekly) measurements
- Average of multiple source tests
- One-time source test
- Other (specify)
- Used default emission factor

Table 35
Equations Y-14 and Y-15 Details Data Element Definitions

Data Element Name	Description
Y14Y15Details	Parent Element (Conditionally Required)
BasisforCO2EmissionsFactor	The basis for the CO ₂ emission factor used in Equation Y-14. [98.256(j)(5)] Below is the list of allowable values. Weekly or more frequent measurements Periodic (less frequent than weekly) measurements Average of multiple source tests One-time source test Other (specify) Used default emission factor

Data Element Name	Description
OtherBasisforCO2EmissionsFactor	Conditionally Required: Specify the basis for the CO ₂ emission factor used in Equation Y-14 if not referenced above. [98.256(j)(5)]
BasisforCH4EmissionsFactor	The basis for the CH ₄ emission factor used in Equation Y-15. [98.256(j)(6)] Below is the list of allowable values. Weekly or more frequent measurements Periodic (less frequent than weekly) measurements Average of multiple source tests One-time source test Other (specify) Used default emission factor
OtherBasisforCH4EmissionsFactor	Conditionally Required: Specify the basis for the CH ₄ emission factor used in Equation Y-15 if not referenced above. [98.256(j)(6)]

XML Excerpt 32
Example for Equations Y-14 and Y-15 Details

```

<ghg:Y14Y15Details>
  <ghg:BasisforCO2EmissionsFactor>One-time source test</ghg:BasisforCO2EmissionsFactor>
  <ghg:BasisforCH4EmissionsFactor>Other (specify)</ghg:BasisforCH4EmissionsFactor>
  <ghg:OtherBasisforCH4EmissionsFactor> Daily measurements</ghg:OtherBasisforCH4EmissionsFactor>
</ghg:Y14Y15Details>
</ghg:AsphaltBlowingUnitDetails>
</ghg:AsphaltBlowingDetails>

```

Note: The XML example above is presented here to demonstrate the concept of reporting the basis for CO₂ and CH₄ emission factors used in Equations Y-14 and Y-15.

6.2 Equation Y-17 Details

Figure 37
Equation Y-17 Details Schema Diagram

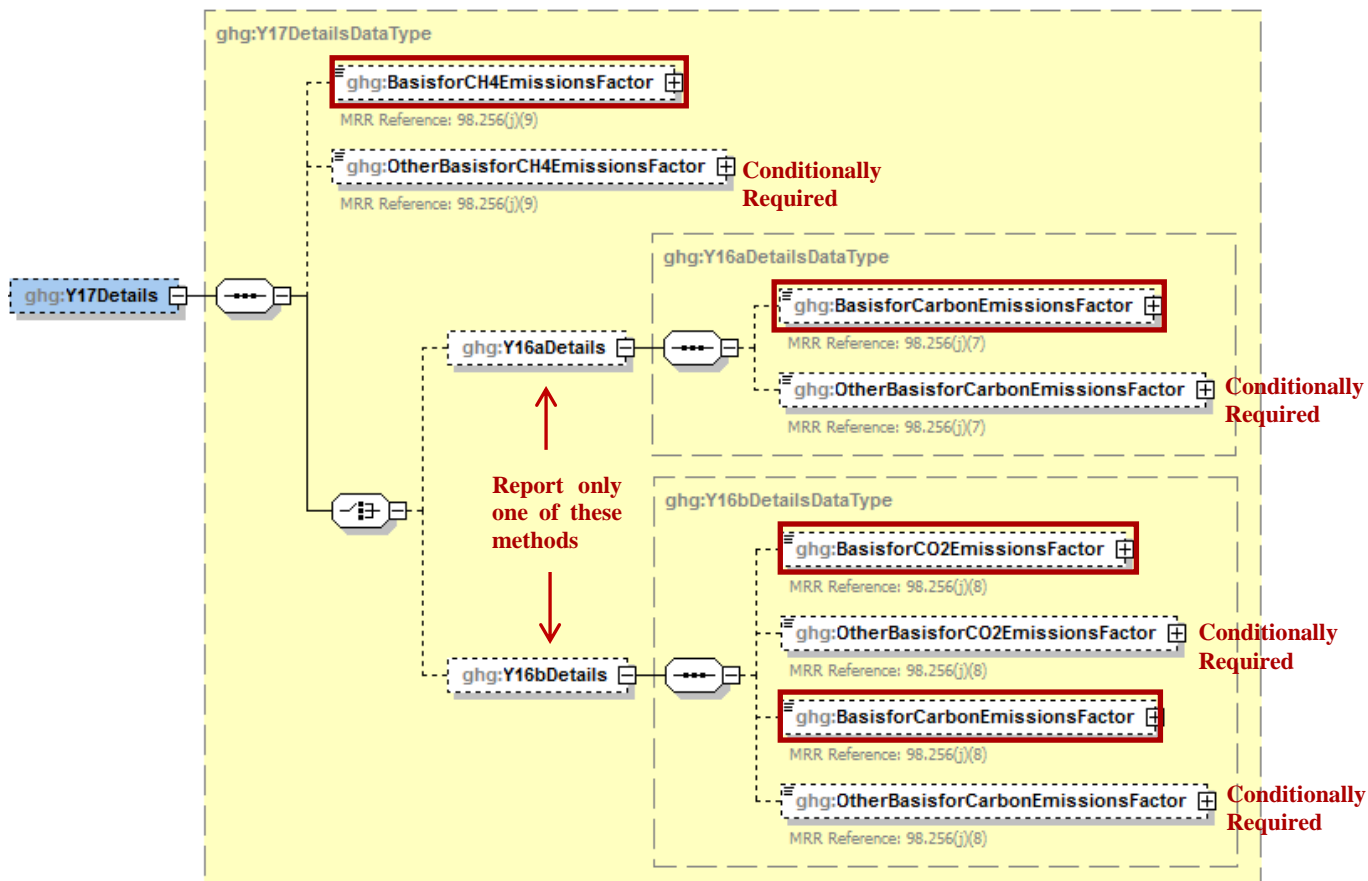

Note: Data elements boxed in red are required. Please see page 4 of this document for more information on conditionally required elements.

Conditionally Required: If you used Equation Y-17 and Equation Y-16a or Y-16b to calculate the CO₂ and CH₄ annual emissions for your asphalt blowing operation, then you must also report the basis for the emissions factors used:

- Weekly or more frequent measurements
- Periodic (less frequent than weekly) measurements
- Average of multiple source tests
- One-time source test
- Other (specify)
- Used default emission factor

Table 36
Equation Y-17 Details Data Element Definitions

Data Element Name	Description
Y17Details	Parent Element (Conditionally Required)
BasisforCH4EmissionsFactor	<p>For each controlled asphalt blowing unit using Equation 17, the basis for the CH₄ emissions factor used in Equation Y-17. [98.256(j)(9)] Below is the list of allowable values.</p> <ul style="list-style-type: none"> Weekly or more frequent measurements Periodic (less frequent than weekly) measurements Average of multiple source tests One-time source test Other (specify) Used default emission factor
OtherBasisforCH4EmissionsFactor	Conditionally Required: Specify the basis for the CH ₄ emissions factor used in Equation Y-17 if not referenced above. [98.256(j)(9)]
Y16aDetails	Parent Element (Conditionally Required)
BasisforCarbonEmissionsFactor	<p>For each controlled asphalt blowing unit using Equation 16a, the basis for the carbon emissions factor used in Equation Y-16a. [98.256(j)(7)] Below is the list of allowable values.</p> <ul style="list-style-type: none"> Weekly or more frequent measurements Periodic (less frequent than weekly) measurements Average of multiple source tests One-time source test Other (specify) Used default emission factor
OtherBasisforCarbonEmissionsFactor	Conditionally Required: Specify the basis for the carbon emissions factor used in Equation Y-16a if not referenced above. [98.256(j)(7)]
Y16bDetails	Parent Element (Conditionally Required)
BasisforCO2EmissionsFactor	<p>For each controlled asphalt blowing unit using Equation 16b, the basis for the CO₂ emissions factor used in Equation Y-16b. [98.256(j)(8)]. Below is the list of allowable values.</p> <ul style="list-style-type: none"> Weekly or more frequent measurements Periodic (less frequent than weekly) measurements Average of multiple source tests One-time source test Other (specify) Used default emission factor

Data Element Name	Description
OtherBasisforCO2EmissionsFactor	Conditionally Required: Specify the basis for the CO ₂ emissions factor used in Equation Y-16b if not referenced above. [98.256(j)(8)]
BasisforCarbonEmissionsFactor	For each controlled asphalt blowing unit using Equation 16b, the basis for the carbon emission factor used in Equation Y-16b. [98.256(j)(8)] Below is the list of allowable values. Weekly or more frequent measurements Periodic (less frequent than weekly) measurements Average of multiple source tests One-time source test Other (specify) Used default emission factor
OtherBasisforCarbonEmissionsFactor	Conditionally Required: Specify the basis for the carbon emissions factor used in Equation Y-16b if not referenced above. [98.256(j)(8)]

**XML Excerpt 33
Example for Equation Y-17 and Y-16a Details**

```

<ghg:Y17Details>
  <ghg:BasisforCH4EmissionsFactor>Periodic (less frequent than weekly) measurements</ghg:BasisforCH4EmissionsFactor>
  <ghg:Y16aDetails>
    <ghg:BasisforCarbonEmissionsFactor>Other (specify)</ghg:BasisforCarbonEmissionsFactor>
    <ghg:OtherBasisforCarbonEmissionsFactor>Bi-weekly measurements</ghg:OtherBasisforCarbonEmissionsFactor>
  </ghg:Y16aDetails>
</ghg:Y17Details>
</ghg:AsphaltBlowingUnitDetails>
</ghg:AsphaltBlowingDetails>
    
```

Note: The XML example above is presented here to demonstrate the concept of reporting the basis for CH₄ and carbon emission factors used in Equations Y-17 and Y-16a.

**XML Excerpt 34
Example for Equation Y-17 and Y-16b Details**

```

<ghg:Y17Details>
  <ghg:BasisforCH4EmissionsFactor>Periodic (less frequent than weekly) measurements</ghg:BasisforCH4EmissionsFactor>
  <ghg:Y16bDetails>
    <ghg:BasisforCO2EmissionsFactor>Average or multiple source tests</ghg:BasisforCO2EmissionsFactor>
    <ghg:BasisforCarbonEmissionsFactor>Weekly or more frequent measurements</ghg:BasisforCarbonEmissionsFactor>
  </ghg:Y16bDetails>
</ghg:Y17Details>
</ghg:AsphaltBlowingUnitDetails>
</ghg:AsphaltBlowingDetails>
    
```

Note: The XML example above is presented here to demonstrate the concept of reporting the basis for CH₄, CO₂, and carbon emission factors used in Equations Y-17 and Y-16b.

6.3 Equation Y-19 Process Vent Method Details

Figure 38
Equation Y-19 Process Vent Method Details Schema Diagram

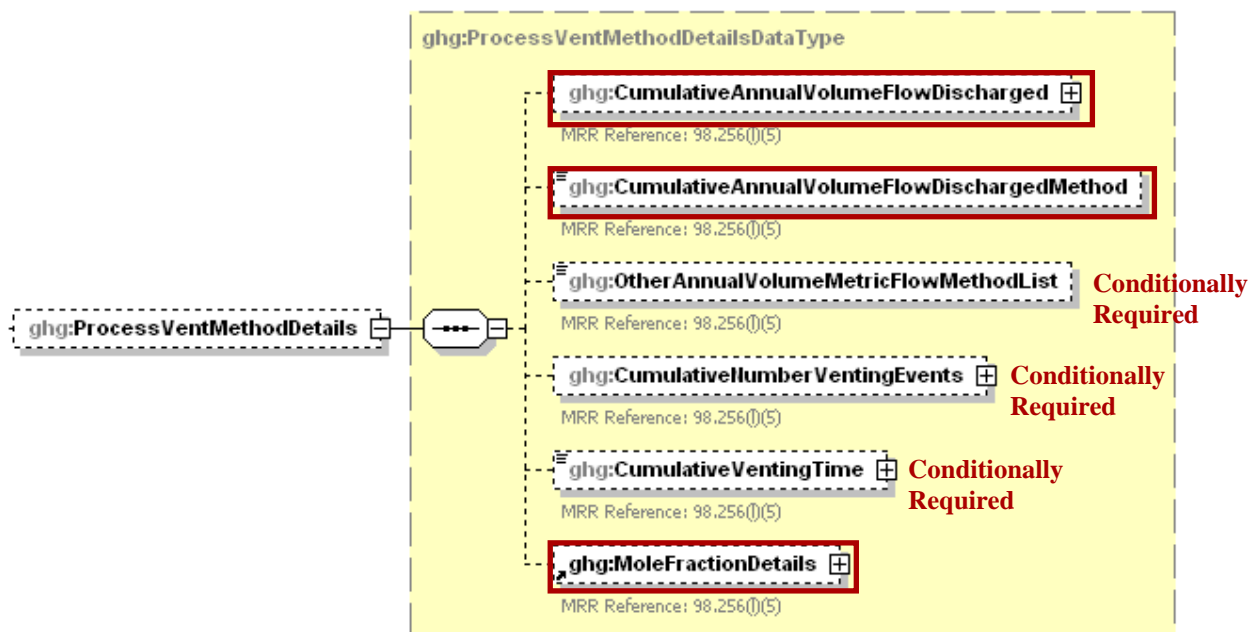

Note: Data elements boxed in red are required. Please see page 4 of this document for more information on conditionally required elements.

Conditionally Required: If Equation Y-19 Process Vent method was used to calculate CO₂ emissions, then report the following:

- Annual volumetric flow discharged to the atmosphere (scf).
- Method used to measure or estimate the annual volumetric flow rate.
 - Continuous or at least hourly measurements
 - Routine (less frequent than hourly but at least weekly) measurements
 - Periodic (less frequent than weekly) measurements
 - Process knowledge
 - Engineering calculation
 - Other (specify)
- **Conditionally Required:** Number of venting events, if vent is intermittent.
- **Conditionally Required:** Cumulative venting time, if vent is intermittent (hours).
- CO₂ and CH₄ mole fraction details. (See [Mole Fraction Details Schema Diagram](#).)

**Table 37
Process Vent Method Details Data Element Definitions**

Data Element Name	Description
ProcessVentMethodDetails	Parent Element (Conditionally Required)
CumulativeAnnualVolumeFlowDischarged	The cumulative annual volumetric flow discharged to the atmosphere. Report the value in the child data element MeasureValue . Set the units of measure to “scf” in the attribute volUOM . [98.256(1)(5)]
CumulativeAnnualVolumeFlowDischargedMethod	The method used to measure or estimate the annual volumetric flow discharged to the atmosphere. Below is the list of allowable values. [98.256(1)(5)] Continuous or at least hourly measurements Routine (less frequent than hourly but at least weekly) measurements Periodic (less frequent than weekly) measurements Process knowledge Engineering calculation Other (specify)
OtherAnnualVolumeMetricFlowMethodList	Conditionally Required: Specify the method used to measure or estimate the annual volumetric flow discharged to the atmosphere if not listed above. [98.256(1)(5)]
CumulativeNumberVentingEvents	Conditionally Required: The number of cumulative venting events for all relevant vents, if vents are intermittent (not applicable for continuous venting). Report the integer value in the child data element MeasureValue . [98.256(1)(5)]
CumulativeVentingTime	Conditionally Required: The cumulative venting time in hours for all intermittent vents. Set the units of measure to “Hours” in the attribute timeUOM . [98.256(1)(5)]

**XML Excerpt 35
Example for Process Vent Method Details**

```

<ghg:ProcessVentMethodDetails>
  <ghg:CumulativeAnnualVolumeFlowDischarged volUOM="scf">
    <ghg:MeasureValue>123</ghg:MeasureValue>
  </ghg:CumulativeAnnualVolumeFlowDischarged>
  <ghg:CumulativeAnnualVolumeFlowDischargedMethod>Process knowledge</ghg:CumulativeAnnualVolumeFlowDischargedMethod>
  <ghg:CumulativeNumberVentingEvents>
    <ghg:MeasureValue>25</ghg:MeasureValue>
  </ghg:CumulativeNumberVentingEvents>
  <ghg:CumulativeVentingTime timeUOM="Hours">187</ghg:CumulativeVentingTime>

```

Note: The XML example above is presented here to demonstrate the concept of reporting details for the process vent method if used to calculate CO₂ emissions for the asphalt blowing unit.

Figure 39
Mole Fraction Details Schema Diagram



Note: Data elements boxed in red are required. Please see page 4 of this document for more information on conditionally required elements.

If Equation Y-19 Process Vent method was used to calculate emissions, then report the following:

- Annual average mole fraction of CO₂.
- Method used to measure or estimate the annual average mole fraction of CO₂.
 - Engineering estimates/process knowledge
 - Direct measurement
 - Other (specify)
- Annual average mole fraction of CH₄.
- Method used to measure or estimate the annual average mole fraction of CH₄.
 - Engineering estimates/process knowledge
 - Direct measurement
 - Other (specify)

Table 38
Mole Fraction Details Data Element Definitions

Data Element Name	Description
MoleFractionDetails	Parent Element
CO2AnnualAverageMoleFraction	Report the annual average mole fraction of CO ₂ . Report the value in the child data element MeasureValue . Set the units of measure to “fraction (number between 0 and 1)” in the attribute fractionUOM . [98.256(1)(5)]
CO2AnnualAverageMoleFractionMethod	Report the method used to measure or estimate the mole fraction of CO ₂ . [98.256(1)(5)] Below is the list of allowable values. Engineering estimates/process knowledge Direct measurement Other (specify)
OtherCO2AnnualAverageMoleFractionMethod	Conditionally Required: Specify the method used to measure or estimate the mole fraction of CO ₂ if not referenced above. [98.256(1)(5)]
CH4AnnualAverageMoleFraction	Report the annual average mole fraction of CH ₄ . Report the value in the child data element MeasureValue . Set the units of measure to “fraction (number between 0 and 1)” in the attribute fractionUOM . [98.256(1)(5)]
CH4AnnualAverageMoleFractionMethod	Report the method used to measure or estimate the mole fraction of CH ₄ . [98.256(1)(5)] Below is the list of allowable values. Engineering estimates/process knowledge Direct measurement Other (specify)
OtherCH4AnnualAverageMoleFractionMethod	Conditionally Required: Specify the method used to measure or estimate the mole fraction of CH ₄ if not referenced above. [98.256(1)(5)]

XML Excerpt 36
Example for Mole Fraction Details

```

<ghg:MoleFractionDetails>
  <ghg:CO2AnnualAverageMoleFraction fractionUOM="fraction (number between 0 and 1)">
    <ghg:MeasureValue>0.5</ghg:MeasureValue>
  </ghg:CO2AnnualAverageMoleFraction>
  <ghg:CO2AnnualAverageMoleFractionMethod>Direct
  measurement</ghg:CO2AnnualAverageMoleFractionMethod>
  <ghg:CH4AnnualAverageMoleFraction fractionUOM="fraction (number between 0 and 1)">
    <ghg:MeasureValue>0.25</ghg:MeasureValue>
  </ghg:CH4AnnualAverageMoleFraction>
  <ghg:CH4AnnualAverageMoleFractionMethod>Engineering estimates/process
  knowledge</ghg:CH4AnnualAverageMoleFractionMethod>
</ghg:MoleFractionDetails>
</ghg:ProcessVentMethodDetails>
</ghg:AsphaltBlowingUnitDetails>
</ghg:AsphaltBlowingDetails>
    
```

Note: The XML example above is presented here to demonstrate the concept of reporting CO₂ and CH₄ mole fraction details.

7.0 Delayed Coking Emissions Summary

7.1 Subpart Level Delayed Coking Details

Required Subpart-Level Summary Data

For petroleum refinery sources required to report under Subpart Y, you are required to report the cumulative methane (CH₄) emissions for all delayed coking units at the facility. You must also report the total number of delayed coking units and the total number of delayed coking drums at the facility and details about each coking drum set at the facility, including the number of coking drums in the set, the basis for the volumetric void fraction of the coke vessel prior to steaming and the basis for the mole fraction of CH₄ in the coking gas.

Figure 40
Delayed Coking Details (Subpart-Level) Schema Diagram

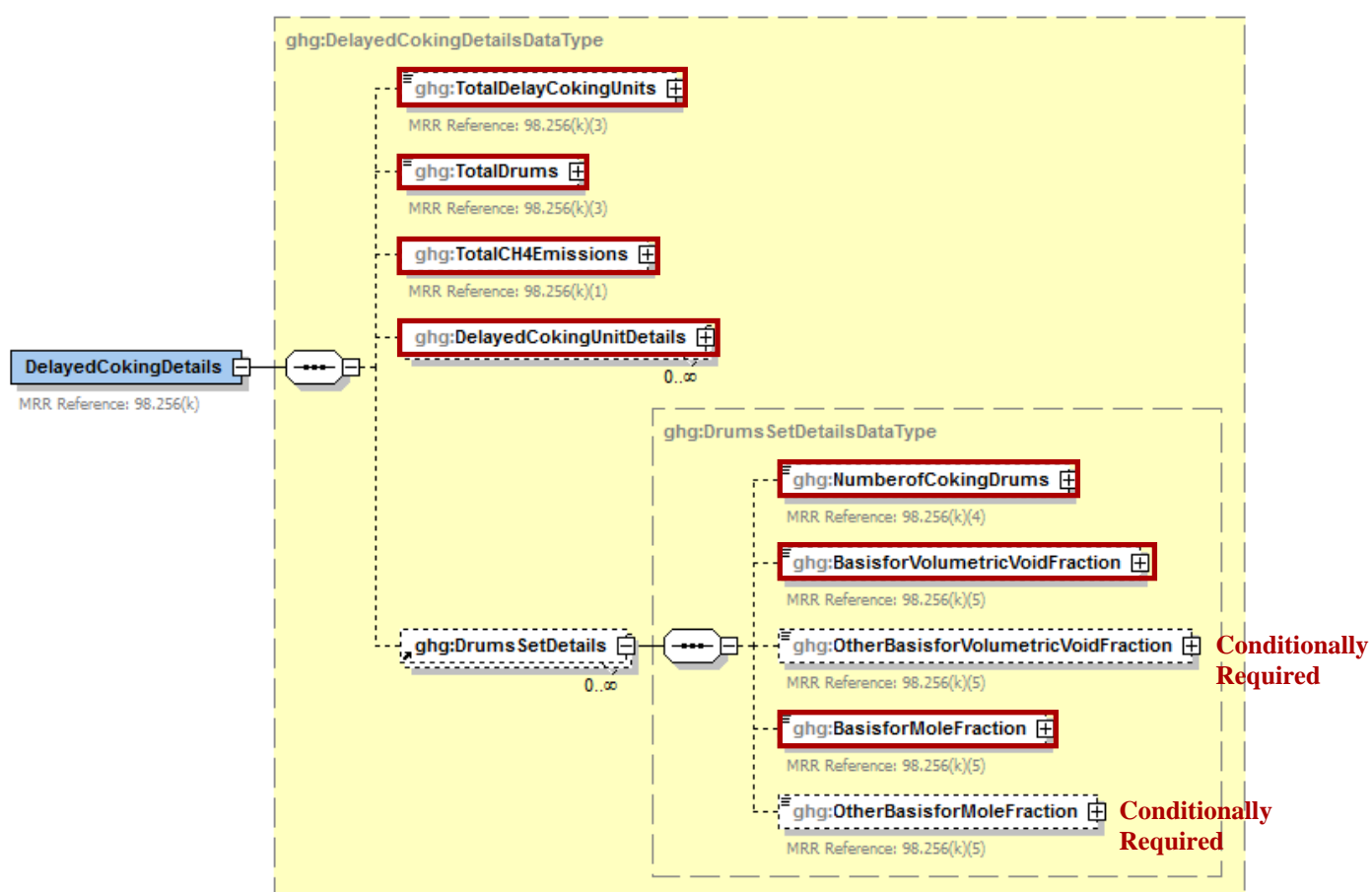

Note: Data elements boxed in red are required. Please see page 4 of this document for more information on conditionally required elements.

Table 39
Delayed Coking Details (Subpart-Level) Data Element Definitions

Data Element Name	Description
DelayedCokingDetails	Parent Element
TotalDelayCokingUnits	The total number of delayed coking units at the facility (integer) [98.256(k)(3)]
TotalDrums	The total number of delayed coking drums at the facility (integer) [98.256(k)(3)]
TotalCH4Emissions	The cumulative annual CH ₄ emissions in metric tons for all delayed coking units at the facility. Report the value in the child data element MeasureValue . Set the units of measure to “Metric Tons” in the attribute massUOM . [98.256(k)(1)]

XML Excerpt 37
Example for Delayed Coking Details (Subpart-Level)

```

<ghg:DelayedCokingDetails>
  <ghg:TotalDelayCokingUnits>10</ghg:TotalDelayCokingUnits>
  <ghg:TotalDrums>28</ghg:TotalDrums>
  <ghg:TotalCH4Emissions massUOM="Metric Tons">
    <ghg:MeasureValue>234.45</ghg:MeasureValue>
  </ghg:TotalCH4Emissions>

```

Note: The XML example above is presented here to demonstrate the concept of reporting the cumulative CH₄ emissions for all delayed coking units at the facility.

7.2 Delayed Coking Unit Details

Conditionally Required Unit-Level Data

The instructions provided below are for unit-level data reporting.

Figure 41
Delayed Coking Details (Unit-Level) Schema Diagram

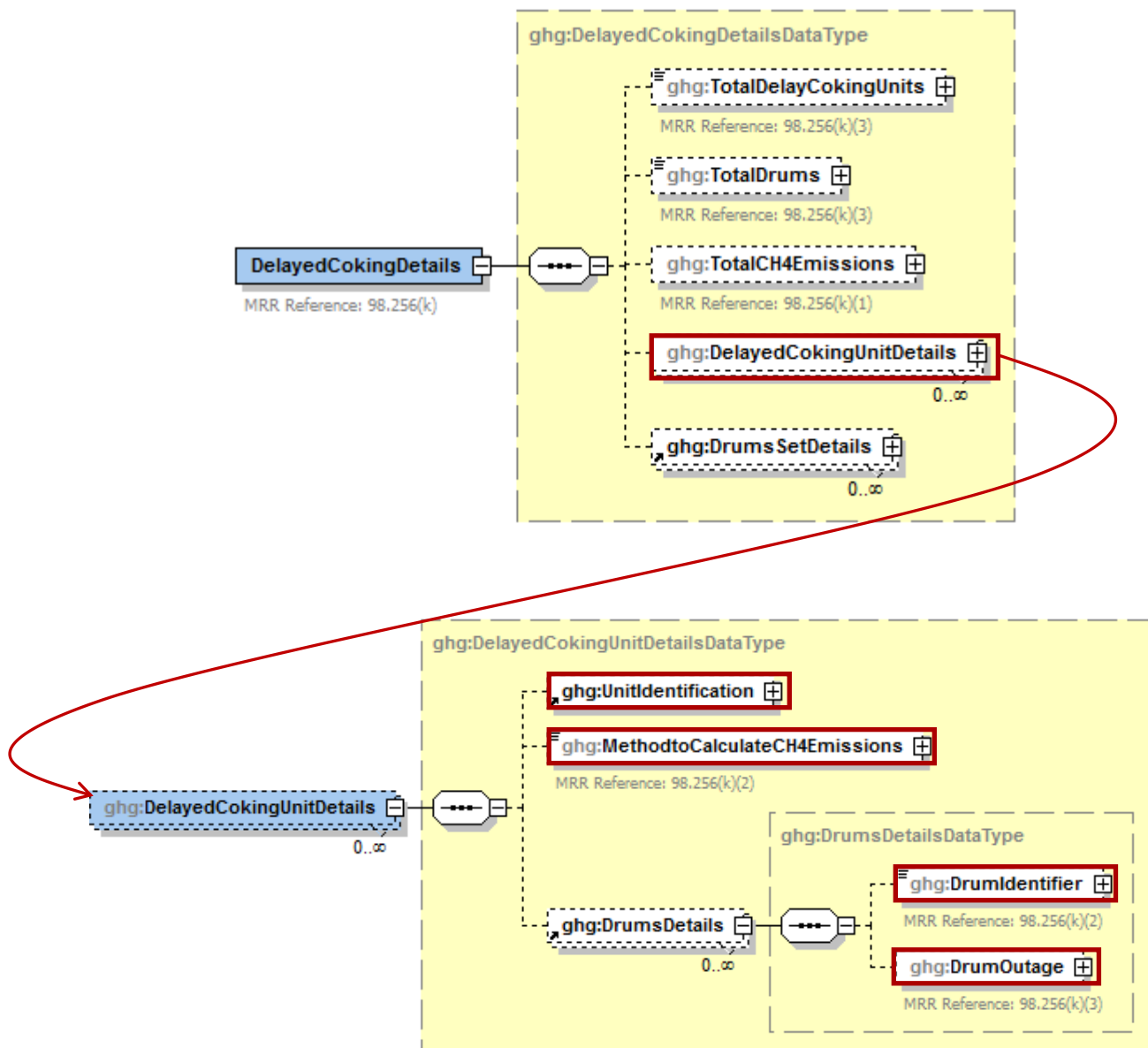

Note: Data elements boxed in red are required. Please see page 4 of this document for more information on conditionally required elements.

Subpart Y requires you to report the following data about each delayed coking unit:

- A unique name or identifier, plus an optional description for your delayed coking unit.
 - The method used to calculate the CH₄ annual emissions for your delayed coking unit.
- Note:** If the method used to calculate CH₄ annual emissions is “Equation Y-18 and Y-19 - 98.253(i)(1)”, you must also add the process vent associated with this delayed coking unit in the

Process Vent section (see [Section 8.0](#)). The emissions that you report for the process vent unit should be zero, because those emissions should be included in the facility-level emissions reported for delayed coking units. Be sure to report "Delayed coking" for the data element "OperationType".

- Details about the drums used for each delayed coking unit.

**Table 40
Delayed Coking Unit Details Data Element Definitions**

Data Element Name	Description
DelayedCokingUnitDetails	Parent Element
UnitIdentification	A collection of data elements containing the identity of each delayed coking unit. Report a unique unit name (ID) in the child data element UnitName , an optional brief description in the child data element UnitDescription and the type of unit in the child data element UnitType . [98.256(k)] Report the following unit type: Delayed Coking Unit
MethodtoCalculateCH4Emissions	Method used to calculate the CH ₄ annual emissions for each delayed coking unit. [98.256(k)(2)] Below is the list of allowable values. Equation Y-18 and Y-19 - 98.253(i)(1) Equation Y-18 - 98.253(i)(2)
DrumsDetails	Parent Element
DrumIdentifier	For each delayed coking unit, a unique identifier/description for each coke drum. [98.256(k)]
DrumOutage	For the specified coke drum, the typical drum outage (i.e. the unfilled distance from the top of the drum). Report the value in the child data element MeasureValue . Set the units of measure to "Feet" in the attribute heightUOM . [98.256(k)(3)]

**XML Excerpt 38
Example for Delayed Coking Unit Details**

```

<ghg:DelayedCokingUnitDetails>
  <ghg:UnitIdentification>
    <ghg:UnitName>DC-001</ghg:UnitName>
    <ghg:UnitDescription>This is a test unit.</ghg:UnitDescription>
    <ghg:UnitType>Delayed Coking Unit</ghg:UnitType>
  </ghg:UnitIdentification>
  <ghg:MethodtoCalculateCH4Emissions> Equation Y-18 and Y-19 - 98.253(i)(1) </ghg:MethodtoCalculateCH4Emissions>
  <ghg:DrumsDetails>
    <ghg:DrumIdentifier>DRUM-001</ghg:DrumIdentifier>
    <ghg:DrumOutage heightUOM="Feet">
      <ghg:MeasureValue>35</ghg:MeasureValue>
    </ghg:DrumOutage>
  </ghg:DrumsDetails>
</ghg:DelayedCokingUnitDetails>

```

Note: The XML example above is presented here to demonstrate the concept of reporting details about the delayed coking unit.

7.3 Coking Drums Set Details

Required Subpart-Level Summary Data

For each set of coking drum dimensions, the facility must report the following:

- The number of coking drums in the set
- The basis for volumetric void fraction of the coke vessel prior to steaming
- The basis for the mole fraction of methane in the coking gas

Table 41
Coking Drums Set Details Data Element Definitions

Data Element Name	Description
DrumsSetDetails	Parent Element (Conditionally Required)
NumberOfCokingDrums	For each set of coking drum dimensions (the combination of height and diameter), report the number of coking drums in the set. [98.256(k)(4)] Note: Although the name/ID of each coking drum set is reported in e-GGRT (web forms), there is no corresponding data element in the schema to report this information.
BasisforVolumetricVoidFraction	For each set of coking drum dimensions, specify the basis for the volumetric void fraction of the coke vessel prior to steaming. [98.256(k)(5)] Below is the list of allowable values. Measurement data Engineering calculation Default value Other (specify)
OtherBasisforVolumetricVoidFraction	Conditionally Required: Specify the basis for the volumetric void fraction of the coke vessel prior to steaming if not listed above.
BasisforMoleFraction	For each set of coking drum dimensions, specify the basis for the mole fraction of methane in the coking gas. [98.256(k)(5)] Below is the list of allowable values. Weekly or more frequent measurements Periodic (less frequent than weekly) measurements Average of multiple source tests One-time source test Engineering calculation Default value Other (specify)
OtherBasisforMoleFraction	Conditionally Required: Specify the basis for the mole fraction of methane in the coking gas if not listed above.

XML Excerpt 39 Example for Coking Drums Set Details

```
<ghg:DrumsSetDetails>  
  <ghg:NumberofCokingDrums>16</ghg:NumberofCokingDrums>  
  <ghg:BasisforVolumetricVoidFraction>Measurement data</ghg:BasisforVolumetricVoidFractio>  
  <ghg:BasisforMoleFraction>Average of multiple source tests</ghg:BasisforMoleFraction>  
</ghg:DrumsSetDetails>  
<ghg:DrumsSetDetails>  
  <ghg:NumberofCokingDrums>12</ghg:NumberofCokingDrums>  
  <ghg:BasisforVolumetricVoidFraction>Other (specify)</ghg:BasisforVolumetricVoidFraction>  
  <ghg:OtherBasisforVolumetricVoidFraction>Bi-monthly</ghg:OtherBasisforVolumetricVoidFraction>  
  <ghg:BasisforMoleFraction>Default value</ghg:BasisforMoleFraction>  
</ghg:DrumsSetDetails>  
</ghg:DelayedCokingDetails>
```

Note: The XML example above is presented here to demonstrate the concept of reporting coking drums set details. There are two drum sets reported.

8.0 Process Vents Unit Information

Conditionally Required Unit-Level Data

This topic provides a step-by-step description of how to enter Subpart Y Process Vents unit information about your facility. You must report CO₂, CH₄ and N₂O emissions from each process vent not specifically included in sections 98.252(a) through 98.252(g).

Figure 42
Process Vents Details (Unit-Level) Schema Diagram

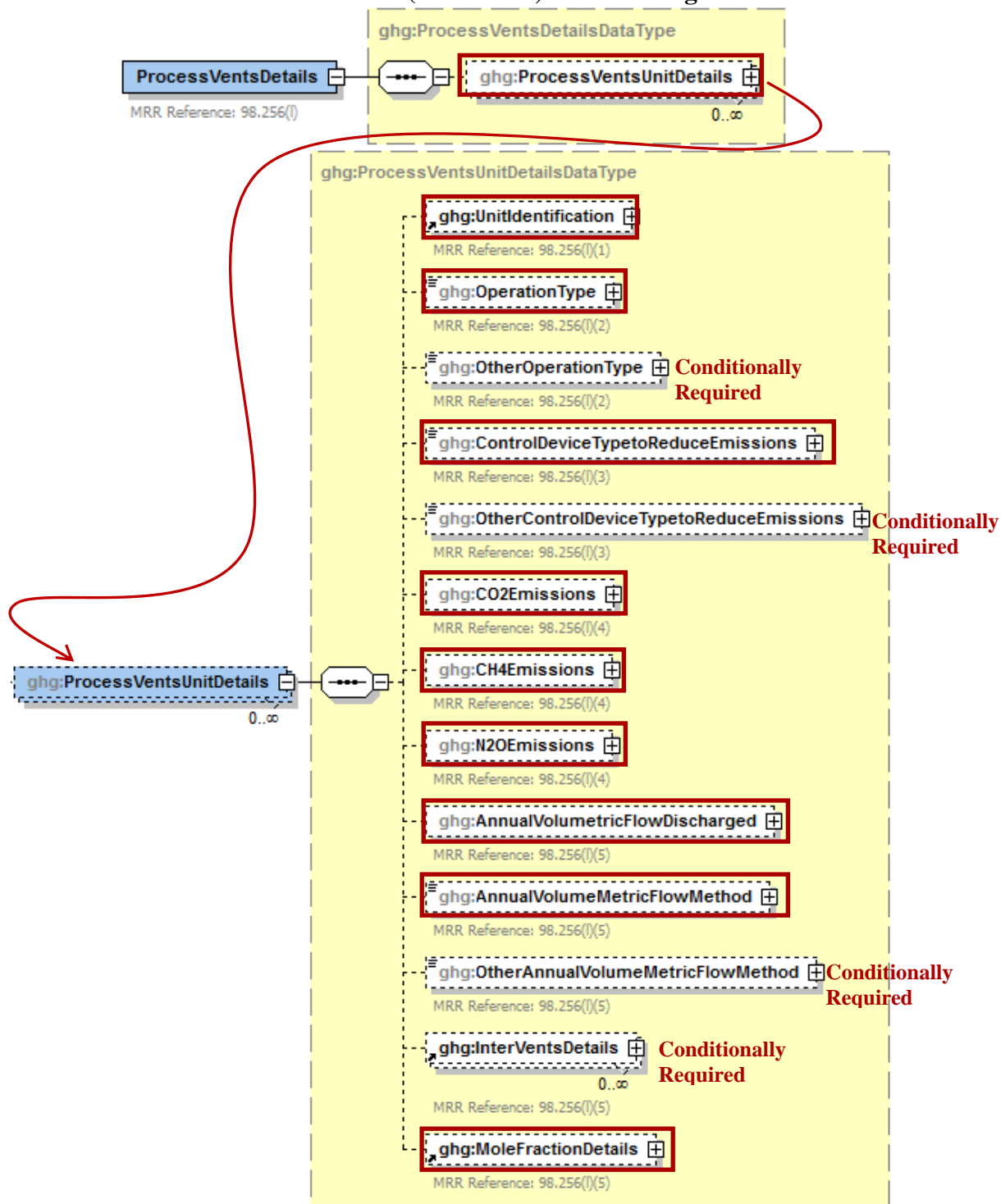

Note: Data elements boxed in red are required. Please see page 4 of this document for more information on conditionally required elements.

Subpart Y collects the following data about each Process Vent meeting the criteria described in 98.253(j):

- A unique name or identifier, plus optional description for the process vent unit. See also [About Unique Unit Names](#).
- Operation type associated with the process vent.
- Control device used to reduce methane (and other organic) emissions from the unit. If not applicable, report “None”.
 - Thermal or catalytic incinerator/oxidizer
 - Carbon adsorber
 - Condenser
 - Oil scrubber
 - None
 - Other (specify)
- **Conditionally Required:** The calculated annual CO₂, CH₄ and N₂O emissions for the process vent, expressed in metric tons of each pollutant emitted. Use Equation Y-19 to calculate values for each of these GHGs. CO₂ emissions must be reported if the process vent contains 2 percent by volume CO₂ or greater. CH₄ emissions must be reported if the process vent contains 0.5 percent by volume of CH₄ or greater. N₂O emissions must be reported if the process vent contains 0.01 percent by volume of N₂O or greater.
- Annual volumetric flow discharged to the atmosphere (scf).
- Method used to measure or estimate the annual volumetric flow rate. Select from:
 - Continuous or at least hourly measurements
 - Routine (less frequent than hourly but at least weekly) measurements
 - Periodic (less frequent than weekly) measurements
 - Process knowledge
 - Engineering calculation
 - Other (specify)

Table 42
Process Vents Unit Details Data Element Definitions

Data Element Name	Description
ProcessVentsDetails	Parent Element (Conditionally Required)
ProcessVentsUnitDetails	Parent Element
UnitIdentification	A collection of data elements containing the identity of each process vent meeting the criteria described in 98.253(j). Report a unique unit name (ID) in the child data element UnitName , an optional brief description in the child data element UnitDescription and the type of unit in the child data element UnitType . [98.256(l)(1)] Report the following unit type: ProcessVent

Data Element Name	Description
OperationType	<p>The type of operation associated with the process vent's emissions. [98.256(1)(2)] Below is the list of allowable values.</p> <ul style="list-style-type: none"> Atmospheric crude distillation Vacuum distillation Delayed coking Fluid coking (traditional) Flexicoking Visbreaking, other thermal cracking Fluid catalytic cracking unit Non-fluid catalytic cracking unit Catalytic hydrocracking Catalytic reforming unit - continuous regeneration Catalytic reforming unit - cyclic regeneration Catalytic reforming unit - semi-regenerative Fuels solvent deasphalting Desulfurization/ hydrotreat - naphtha/reformer feed Desulfurization/ hydrotreat - gasoline Desulfurization/ hydrotreat - kerosene/jet fuel Desulfurization/ hydrotreat - diesel Desulfurization/ hydrotreat - other distillate Desulfurization/ hydrotreat - residual Desulfurization/ hydrotreat - heavy gas oil Desulfurization/ hydrotreat - other HF alkylation H2SO4 alkylation Aromatics production Asphalt production Isomerization - Isobutane Isomerization - Iso C5,C6 Lubricants production Petroleum coke storage Sulfur plant Gas plant (LPG production unit) Oxygenate plant - MTBE Oxygenate plant - ETBE Oxygenate plant - TAME Oxygenate plant - other (specify) Marine vessel loading/unloading Truck/tank truck loading/unloading Rail car loading/unloading Blow down system Knock-out pot Analyzer Vacuum jet exhaust Wastewater treatment unit Wastewater collection system (drain, junction box, etc.) Soil remediation Other
OtherOperationType	<p>Conditionally Required: Specify the type of operation associated with the emissions if not referenced above. [98.256(1)(2)]</p>

Data Element Name	Description
ControlDeviceTypetoReduceEmissions	<p>The type of control device used to reduce methane (and other organic) emissions from the unit. If not applicable, report "None". [98.256(1)(3)] Below is the list of allowable values.</p> <ul style="list-style-type: none"> Thermal or catalytic incinerator/oxidizer Carbon adsorber Condenser Oil scrubber None Other (specify)
OtherControlDeviceTypetoReduceEmissions	<p>Conditionally Required: Specify the type of control device used to reduce methane (and other organic) emissions from the unit if not referenced above. [98.256(1)(3)]</p>
CO2Emissions	<p>Conditionally Required: If the process vent contains 2 percent by volume CO₂ or greater, report the calculated annual CO₂ emissions for the vent. Report the value in the child data element CalculatedValue. Set the units of measure to "Metric Tons" in the attribute massUOM. [98.256(1)(4)]</p>
CH4Emissions	<p>Conditionally Required: If the process vent contains 0.5 percent by volume CH₄ or greater, report the calculated annual CH₄ emissions for the vent. Report the value in the child data element CalculatedValue. Set the units of measure to "Metric Tons" in the attribute massUOM. [98.256(1)(4)]</p>
N2OEmissions	<p>Conditionally Required: If the process vent contains 0.01 percent by volume N₂O or greater, report the calculated annual N₂O emissions for the vent. Report the value in the child data element CalculatedValue. Set the units of measure to "Metric Tons" in the attribute massUOM. [98.256(1)(4)]</p>
AnnualVolumetricFlowDischarged	<p>The annual volumetric flow discharged to the atmosphere. Report the value in the child data element MeasureValue. Set the units of measure to "scf" in the attribute rateUOM. [98.256(1)(5)]</p>
AnnualVolumeMetricFlowMethod	<p>The method used to measure or estimate the annual volumetric flow rate. [98.256(1)(5)] Below is the list of allowable values.</p> <ul style="list-style-type: none"> Continuous or at least hourly measurements Routine (less frequent than hourly but at least weekly) measurements Periodic (less frequent than weekly) measurements Process knowledge Engineering calculation Other (specify)
OtherAnnualVolumeMetricFlowMethod	<p>Conditionally Required: Specify the method used to measure or estimate the annual volumetric flow rate if not referenced above. [98.256(1)(5)]</p>

XML Excerpt 40 Example for Process Vents Unit Details

```

<ghg:ProcessVentsDetails>
  <ghg:ProcessVentsUnitDetails>
    <ghg:UnitIdentification>
      <ghg:UnitName>PV-001</ghg:UnitName>
      <ghg:UnitType>Process Vent</ghg:UnitType>
    </ghg:UnitIdentification>
    <ghg:OperationType>Petroleum coke storage</ghg:OperationType>
    <ghg:ControlDeviceTypeToReduceEmissions>Thermal or catalytic
    incinerator/oxidizer</ghg:ControlDeviceTypeToReduceEmissions>
    <ghg:CO2Emissions massUOM="Metric Tons">
      <ghg:CalculatedValue>3242.2</ghg:CalculatedValue>
    </ghg:CO2Emissions>
    <ghg:CH4Emissions massUOM="Metric Tons">
      <ghg:CalculatedValue>1004.34</ghg:CalculatedValue>
    </ghg:CH4Emissions>
    <ghg:N2OEmissions massUOM="Metric Tons">
      <ghg:CalculatedValue>235.234</ghg:CalculatedValue>
    </ghg:N2OEmissions>
    <ghg:AnnualVolumetricFlowDischarged rateUOM="scf">
      <ghg:MeasureValue>3444.23442</ghg:MeasureValue>
    </ghg:AnnualVolumetricFlowDischarged>
    <ghg:AnnualVolumeMetricFlowMethod>Continuous or at least hourly
    measurements</ghg:AnnualVolumeMetricFlowMethod>
  </ghg:ProcessVentsUnitDetails>
</ghg:ProcessVentsDetails>
    
```

Note: The XML example above is presented here to demonstrate the concept of reporting details about a process vents unit.

Figure 43 Intermittent Vents Details Schema Diagram

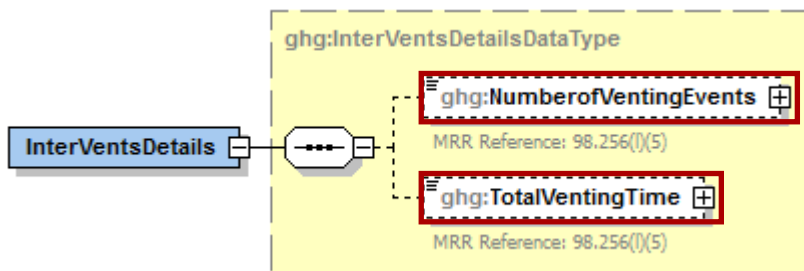

Note: Data elements boxed in red are required.

Conditionally Required: Subpart Y collects the following data for each intermittent Process Vent (not applicable for continuous venting):

- The number of venting events
- Cumulative venting time (hours)

Table 43 Intermittent Vents Details Data Element Definitions

Data Element Name	Description
InterVentsDetails	Parent Element (Conditionally Required)
NumberOfVentingEvents	The number of venting events (integer). [98.256(1)(5)]
TotalVentingTime	The cumulative venting time. Set the units of measure to “Hours” in the attribute timeUOM . [98.256(1)(5)]

XML Excerpt 41 Example for Intermittent Vents Details

```
<ghg:InterVentsDetails>
  <ghg:NumberofVentingEvents>3</ghg:NumberofVentingEvents>
  <ghg:TotalVentingTime timeUOM="Hours">40</ghg:TotalVentingTime>
</ghg:InterVentsDetails>
```

Note: The XML example above is presented here to demonstrate the concept of reporting the details of the intermittent vents.

Figure 44 Mole Fraction Details Schema Diagram

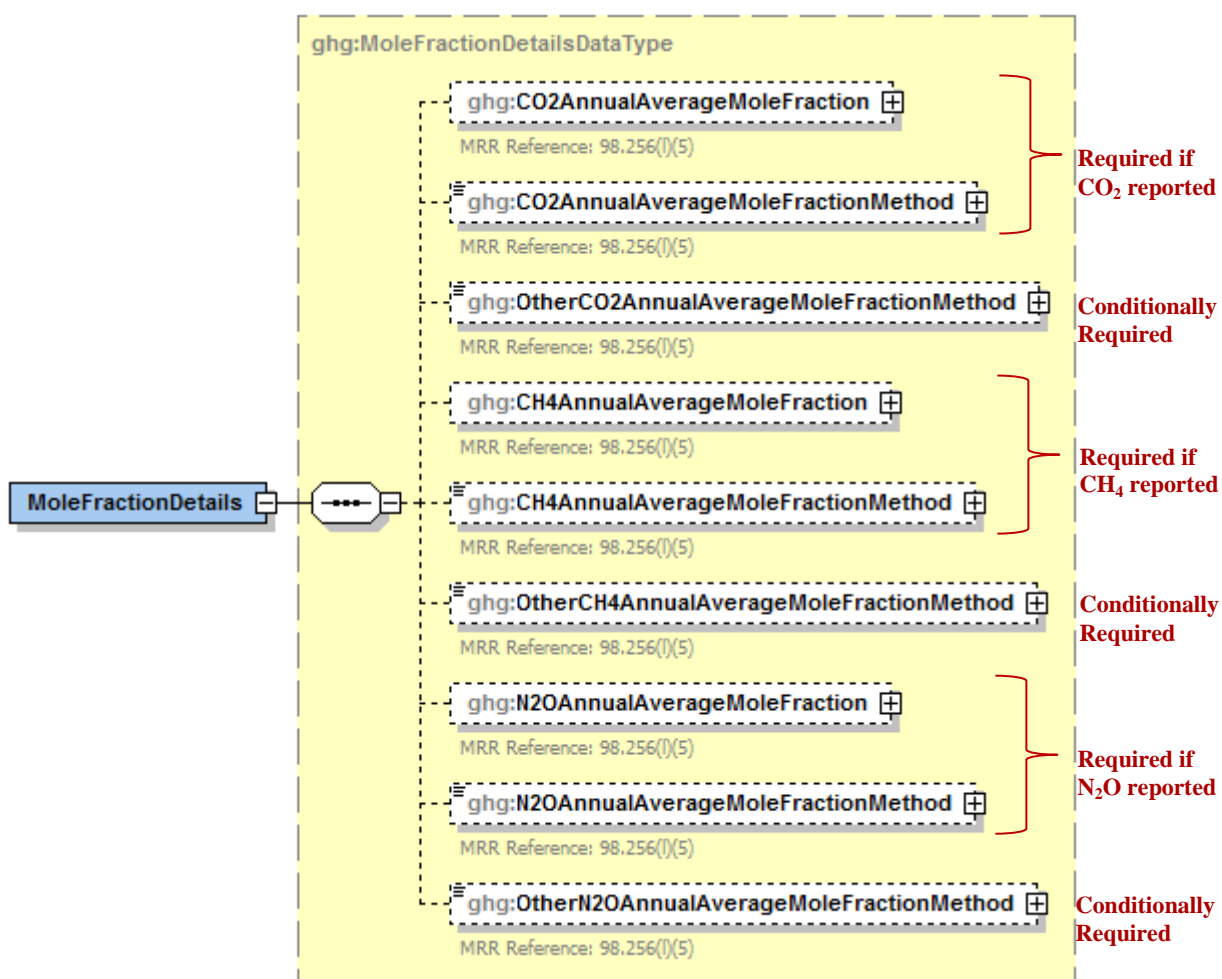

Note: Data elements boxed in red are required. Please see page 4 of this document for more information on conditionally required elements.

Conditionally Required: Subpart Y collects the following data if CO₂ is being reported for this Process Vent:

- Annual average mole fraction of CO₂.
- Method used to measure or estimate the annual average mole fraction of CO₂.
 - Engineering estimates/process knowledge
 - Direct measurement
 - Other (specify)

Conditionally Required: Subpart Y collects the following data if CH₄ is being reported for this Process Vent:

- Annual average mole fraction of CH₄.
- Method used to measure or estimate the annual average mole fraction of CH₄.
 - Engineering estimates/process knowledge
 - Direct measurement
 - Other (specify)

Conditionally Required: Subpart Y collects the following data if N₂O is being reported for this Process Vent:

- Annual average mole fraction of N₂O.
- Method used to measure or estimate the annual average mole fraction of N₂O.
 - Engineering estimates/process knowledge
 - Direct measurement
 - Other (specify)

Table 44
Mole Fraction Details Data Element Definitions

Data Element Name	Description
MoleFractionDetails	Parent Element
CO2AnnualAverageMoleFraction	Conditionally Required: If CO ₂ was reported for the unit, report the annual average mole fraction of CO ₂ . Report the value in the child data element MeasureValue . Set the units of measure to “fraction (number between 0 and 1)” in the attribute fractionUOM . [98.256(1)(5)]
CO2AnnualAverageMoleFractionMethod	Conditionally Required: If CO ₂ was reported for the unit, report the method used to measure or estimate the CO ₂ mole fraction. [98.256(1)(5)] Below is the list of allowable values. Engineering estimates/process knowledge Direct measurement Other (specify)
OtherCO2AnnualAverageMoleFractionMethod	Conditionally Required: Specify the method used to measure or estimate the CO ₂ mole fraction if not referenced above. [98.256(1)(5)]

Data Element Name	Description
CH4AnnualAverageMoleFraction	Conditionally Required: If CH ₄ was reported for the unit, report the annual average mole fraction of CH ₄ . Report the value in the child data element MeasureValue . Set the units of measure to “fraction (number between 0 and 1)” in the attribute fractionUOM . [98.256(1)(5)]
CH4AnnualAverageMoleFractionMethod	Conditionally Required: If CH ₄ was reported for the unit, report the method used to measure or estimate the CH ₄ mole fraction. [98.256(1)(5)] Below is the list of allowable values. Engineering estimates/process knowledge Direct measurement Other (specify)
OtherCH4AnnualAverageMoleFractionMethod	Conditionally Required: Specify the method used to measure or estimate the CH ₄ mole fraction if not referenced above. [98.256(1)(5)]
N2OAnnualAverageMoleFraction	Conditionally Required: If N ₂ O was reported for the unit, report the annual average mole fraction of N ₂ O. Report the value in the child data element MeasureValue . Set the units of measure to “fraction (number between 0 and 1)” in the attribute fractionUOM . [98.256(1)(5)]
N2OAnnualAverageMoleFractionMethod	Conditionally Required: If N ₂ O was reported for the unit, report the method used to measure or estimate the N ₂ O mole fraction. [98.256(1)(5)] Below is the list of allowable values. Engineering estimates/process knowledge Direct measurement Other (specify)
OtherN2OAnnualAverageMoleFractionMethod	Conditionally Required: Specify the method used to measure or estimate the N ₂ O mole fraction if not referenced above. [98.256(1)(5)]

**XML Excerpt 42
Example for Mole Fraction Details**

```

<ghg:MoleFractionDetails>
  <ghg:CO2AnnualAverageMoleFraction fractionUOM="fraction (number between 0 and 1)">
    <ghg:MeasureValue>0.5</ghg:MeasureValue>
  </ghg:CO2AnnualAverageMoleFraction>
  <ghg:CO2AnnualAverageMoleFractionMethod>Direct measurement</ghg:CO2AnnualAverageMoleFractionMethod>
  <ghg:CH4AnnualAverageMoleFraction fractionUOM="fraction (number between 0 and 1)">
    <ghg:MeasureValue>0.33</ghg:MeasureValue>
  </ghg:CH4AnnualAverageMoleFraction>
  <ghg:CH4AnnualAverageMoleFractionMethod> Direct measurement</ghg:CH4AnnualAverageMoleFractionMethod>
  <ghg:N2OAnnualAverageMoleFraction fractionUOM="fraction (number between 0 and 1)">
    <ghg:MeasureValue>0.75</ghg:MeasureValue>
  </ghg:N2OAnnualAverageMoleFraction>
  <ghg:N2OAnnualAverageMoleFractionMethod>Other (specify)</ghg:N2OAnnualAverageMoleFractionMethod>
  <ghg:OtherN2OAnnualAverageMoleFractionMethod>test method
2</ghg:OtherN2OAnnualAverageMoleFractionMethod>
</ghg:MoleFractionDetails>
    
```

Note: The XML example above is presented here to demonstrate the concept of reporting the CO₂, CH₄ and N₂O mole fraction details.

9.0 Uncontrolled Blowdown Systems

Required Subpart-Level Summary Data

For petroleum refinery sources required to report under Subpart Y, you are required to report the method used to calculate the CH₄ emissions. If the facility does not have uncontrolled blowdown systems, that must be reported. If the facility does have uncontrolled blowdown systems, the annual CH₄ emissions must be reported in metric tons.

Figure 45
Uncontrolled Blowdown Details Schema Diagram

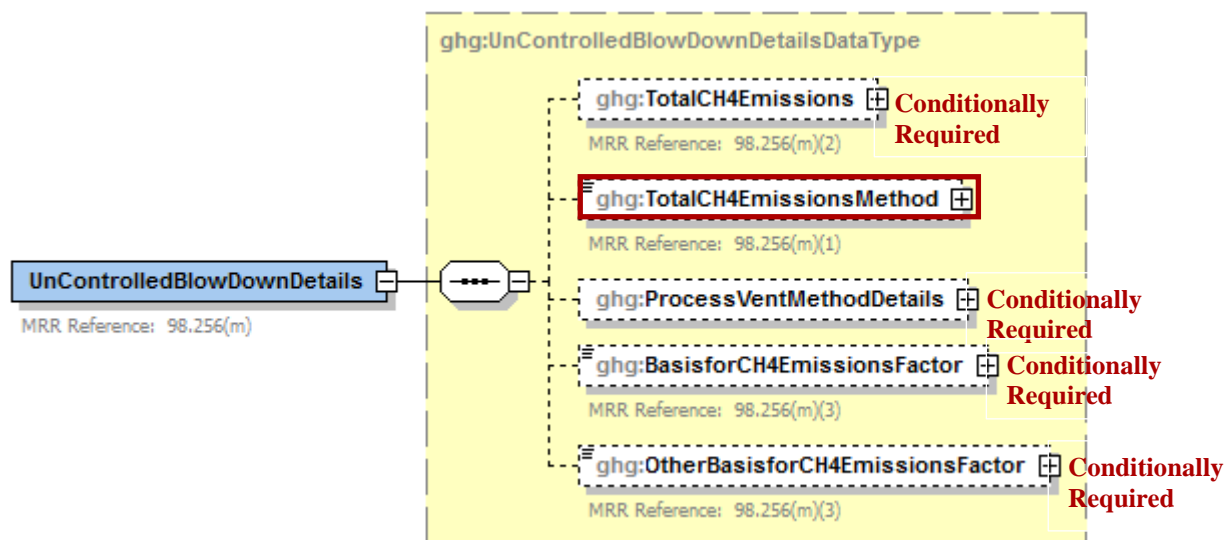

Note: Data elements boxed in red are required. Please see page 4 of this document for more information on conditionally required elements.

Note: Blowdown systems in which the uncondensed gas stream is routed to a flare or similar control device are considered to be controlled.

Specify the CH₄ Estimation Method

Subpart Y requires you to specify the appropriate option regarding the facility's uncontrolled blowdown system:

- You used equation Y-20 to estimate CH₄ emissions. [98.253(k)]
- You used a process vents method to estimate CH₄ emissions. [98.253 (j)]
- The facility does not have any uncontrolled blowdown systems.

If the facility does not have any uncontrolled blowdown systems, then no further data is collected for uncontrolled blowdown systems.

Equation Y-20 Summary and Result

To calculate the annual CH₄ emissions from blowdown systems, you can download the Y-20 spreadsheet from the e-GGRT help site or use the following information:

$$\text{CH}_4 = (\text{Q}_{\text{Ref}} \times \text{EF}_{\text{BD}} \times 16/\text{MVC} \times 0.001)$$

Where:

CH₄ = Methane emission rate from blowdown systems (Metric Tons CH₄/year).
 Q_{Ref} = Quantity of crude oil plus the quantity of intermediate products received

- EFBD = from off site that are processed at the facility (MMbbl/year).
- EFBD = Methane emission factor for uncontrolled blown systems (scf CH₄/MMbbl); default is 137,000.
- 16 = Molecular weight of CH₄ (kg/kg-mole).
- MVC = Molar volume conversion factor (849.5 scf/kg-mole at 68 °F and 14.7 psia or 836.6 scf/kg-mole at 60 °F and 14.7 psia).
- 0.001 = Conversion factor (metric ton/kg).

**Table 45
UnControlledBlowDownDetails Data Element Definitions**

Data Element Name	Description
UnControlledBlowDownDetails	Parent Element: A collection of data elements containing the cumulative annual methane (CH ₄) emissions, expressed in metric tons, from uncontrolled blowdown systems and the method used to calculate the CH ₄ emissions.
TotalCH4Emissions	Conditionally Required: The cumulative annual CH ₄ emissions (in metric tons of CH ₄) for uncontrolled blowdown systems. Report the value in the child data element CalculatedValue . Set the units of measure to “Metric Tons” in the attribute massUOM . [98.256(m)(2)]
TotalCH4EmissionsMethod	The method used for calculating CH ₄ emissions from uncontrolled blowdown systems [98.256(m)(1)]. Below is the list of allowable values. Reported under 98.256(k) Reported under 98.256(j) No uncontrolled blowdown systems

**XML Excerpt 43
Example for Uncontrolled Blowdown System Details**

```

<ghg:UnControlledBlowDownDetails>
  <ghg:TotalCH4Emissions massUOM="Metric Tons">
    <ghg:CalculatedValue>4878.24</ghg:CalculatedValue>
  </ghg:TotalCH4Emissions>
  <ghg:TotalCH4EmissionsMethod>Reported under 98.256(j)</ghg:TotalCH4EmissionsMethod>

```

Note: The XML example above is presented here to demonstrate the concept of reporting uncontrolled blowdown systems details if you used the process vent method to calculate CH₄ emissions

Figure 46
Process Vent Method Details Schema Diagram

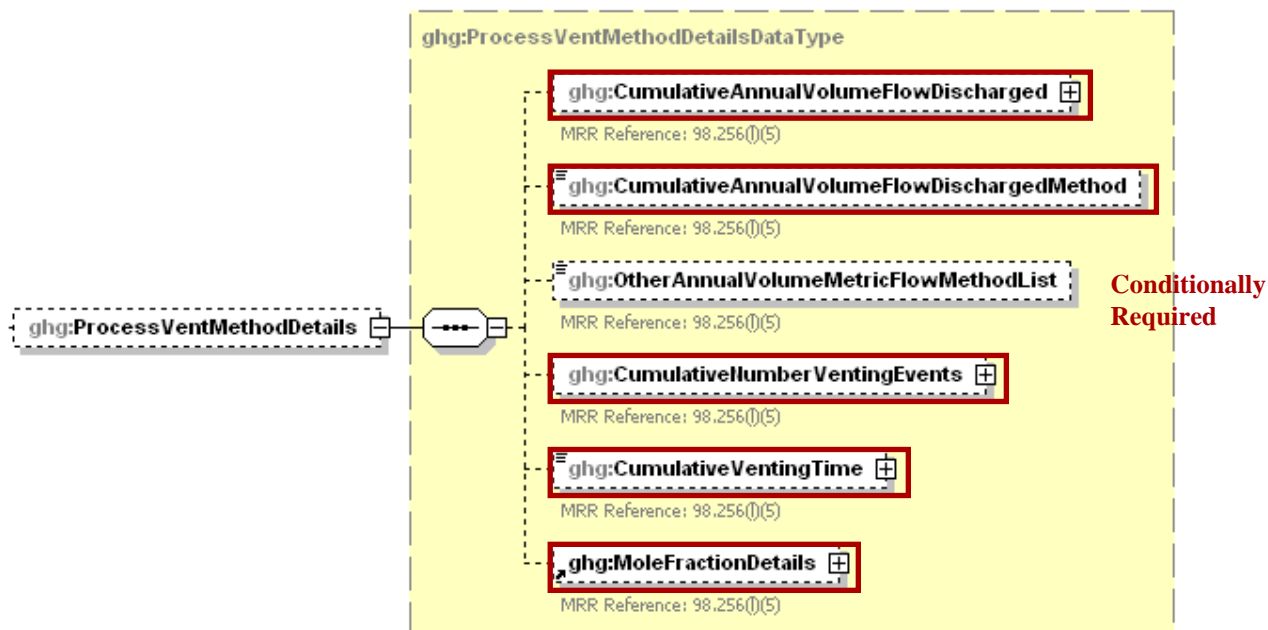

Note: Data elements boxed in red are required. Please see page 4 of this document for more information on conditionally required elements.

Process Vent Method for Uncontrolled Blowdown Systems

Conditionally Required: Report the following data if you used a process vents method (under 98.256(j)) to calculate the CH₄ emissions from uncontrolled blowdown systems:

- Annual volumetric flow discharged to the atmosphere (scf).
- Method used to measure or estimate the annual volumetric flow rate. Select from:
 - Continuous or at least hourly measurements
 - Routine (less frequent than hourly but at least weekly) measurements
 - Periodic (less frequent than weekly) measurements
 - Process knowledge
 - Engineering calculation
 - Other (specify)
- **Conditionally Required:** Number of venting events for all relevant vents, if vent is intermittent
- **Conditionally Required:** Cumulative venting time, if vent is intermittent (hours)
- CH₄ mole fraction details. (See [Mole Fraction Details Schema Diagram](#).)

Table 46
Process Vent Method Details Data Element Definitions

Data Element Name	Description
ProcessVentMethodDetails	Parent Element (Conditionally Required): A collection of data elements required if the process vent method was used to calculate CH ₄ emissions.
CumulativeAnnualVolumeFlowDischarged	The cumulative annual volumetric flow discharged to the atmosphere. Report the value in the child data element MeasureValue . Set the units of measure to “scf” in the attribute volUOM . [98.256(1)(5)]
CumulativeAnnualVolumeFlowDischargedMethod	The method used to measure the volumetric flow discharged to the atmosphere. [98.256(1)(5)] Below is the list of allowable values. Continuous or at least hourly measurements Routine (less frequent than hourly but at least weekly) measurements Periodic (less frequent than weekly) measurements Process knowledge Engineering calculation Other (specify)
OtherAnnualVolumeMetricFlowMethodList	Conditionally Required: The name of the method used to measure the volumetric flow discharged to the atmosphere if not found in the list of allowable methods.
CumulativeNumberVentingEvent	Conditionally Required: The number of cumulative venting events for all relevant vents, if vents are intermittent (not applicable for continuous venting). Report the integer value in the child data element MeasureValue . [98.256(1)(5)]
CumulativeVentingTime	Conditionally Required: The cumulative venting time in hours for all intermittent vents. Set the units of measure to “Hours” in the attribute timeUOM . [98.256(1)(5)]

XML Excerpt 44
Example for Process Vent Method Details

```

<ghg:ProcessVentMethodDetails>
  <ghg:CumulativeAnnualVolumeFlowDischarged volUOM="scf">
    <ghg:MeasureValue>212.0</ghg:MeasureValue>
  </ghg:CumulativeAnnualVolumeFlowDischarged>
  <ghg:CumulativeAnnualVolumeFlowDischargedMethod>Process knowledge</ghg:CumulativeAnnualVolumeFlowDischargedMethod>
  <ghg:CumulativeNumberVentingEvents>
    <ghg:MeasureValue>23</ghg:MeasureValue>
  <ghg:CumulativeVentingTime timeUOM="Hours">54</ghg:CumulativeVentingTime>

```

Note: The XML example above is presented here to demonstrate the concept of reporting uncontrolled blowdown systems details if you used the process vent method to calculate CH₄ emissions.

Figure 47
Mole Fraction Details Schema Diagram



Note: Data elements boxed in red are required. Please see page 4 of this document for more information on conditionally required elements.

If a process vents method was used to estimate CH₄ emissions, then report the following:

- Annual average mole fraction of CH₄.
- Method used to measure or estimate the annual average mole fraction of CH₄.
 - Engineering estimates/process knowledge
 - Direct measurement
 - Other (specify)

**Table 47
Mole Fraction Details Data Element Definitions**

Data Element Name	Description
MoleFractionDetails	Parent Element
CH4AnnualAverageMoleFraction	Report the annual average mole fraction of CH ₄ . Report the value in the child data element MeasureValue . Set the units of measure to “fraction (number between 0 and 1)” in the attribute fractionUOM . [98.256(l)(5)]
CH4AnnualAverageMoleFractionMethod	Report the method used to measure or estimate the mole fraction of CH ₄ . [98.256(l)(5)] Below is the list of allowable values. Engineering estimates/process knowledge Direct measurement Other (specify)
OtherCH4AnnualAverageMoleFractionMethod	Conditionally Required: Specify the method used to measure or estimate the mole fraction of CH ₄ if not referenced above. [98.256(l)(5)]

**XML Excerpt 45
Example for Mole Fraction Details**

```

<ghg:MoleFractionDetails>
  <ghg:CH4AnnualAverageMoleFraction fractionUOM="fraction (number between 0 and 1)">
    <ghg:MeasureValue>0.5</ghg:MeasureValue>
  </ghg:CH4AnnualAverageMoleFraction>
  <ghg:CH4AnnualAverageMoleFractionMethod>Direct measurement</ghg:CH4AnnualAverageMoleFractionMethod>
</ghg:MoleFractionDetails>
</ghg:ProcessVentMethodDetails>
    
```

Note: The XML example above is presented here to demonstrate the concept of reporting the CH₄ mole fraction details.

Conditionally Required: Report the following data if the uncontrolled blowdown emissions are reported under 98.256(k) (Equation Y-20 was used):

- The basis for the methane emission factor value.
 - Company records
 - Measurement data
 - Process Knowledge/Engineering calculation
 - Used default emission factor
 - Other

Table 48
Basis for CH₄ Emissions Factor Data Element Definitions

Data Element Name	Description
BasisforCH4EmissionsFactor	<p>Conditionally Required: For uncontrolled blowdown systems reporting under 98.253(k), the basis for the CH₄ emission factor value. [98.256(m)(3)] Below is the list of allowable values.</p> <p>Company records Measurement data Process knowledge/engineering calculation Used default emission factor Other (specify)</p>
OtherBasisforCH4EmissionsFactor	<p>Conditionally Required: Specify the basis used for determining the CH₄ emissions factor if not listed in the set of allowable values above.</p>

XML Excerpt 46
Example for Basis for CH₄ Emissions Factor

```

<ghg:BasisforCH4EmissionsFactor>Company records</ghg:BasisforCH4EmissionsFactor>
</ghg:UnControlledBlowDownDetails>
```

Note: The XML example above is presented here to demonstrate the concept of reporting the basis for the CH₄ emission factor if you used Equation Y-20.

10.0 Equipment Leaks

Required Subpart-Level Summary Data

For petroleum refinery sources required to report under Subpart Y, you are required to report the report cumulative CH₄ emissions from all equipment leak sources in metric tons. You must also specify the method used to calculate the reported equipment leak emissions.

**Figure 48
Equipment Leaks Details Schema Diagram**

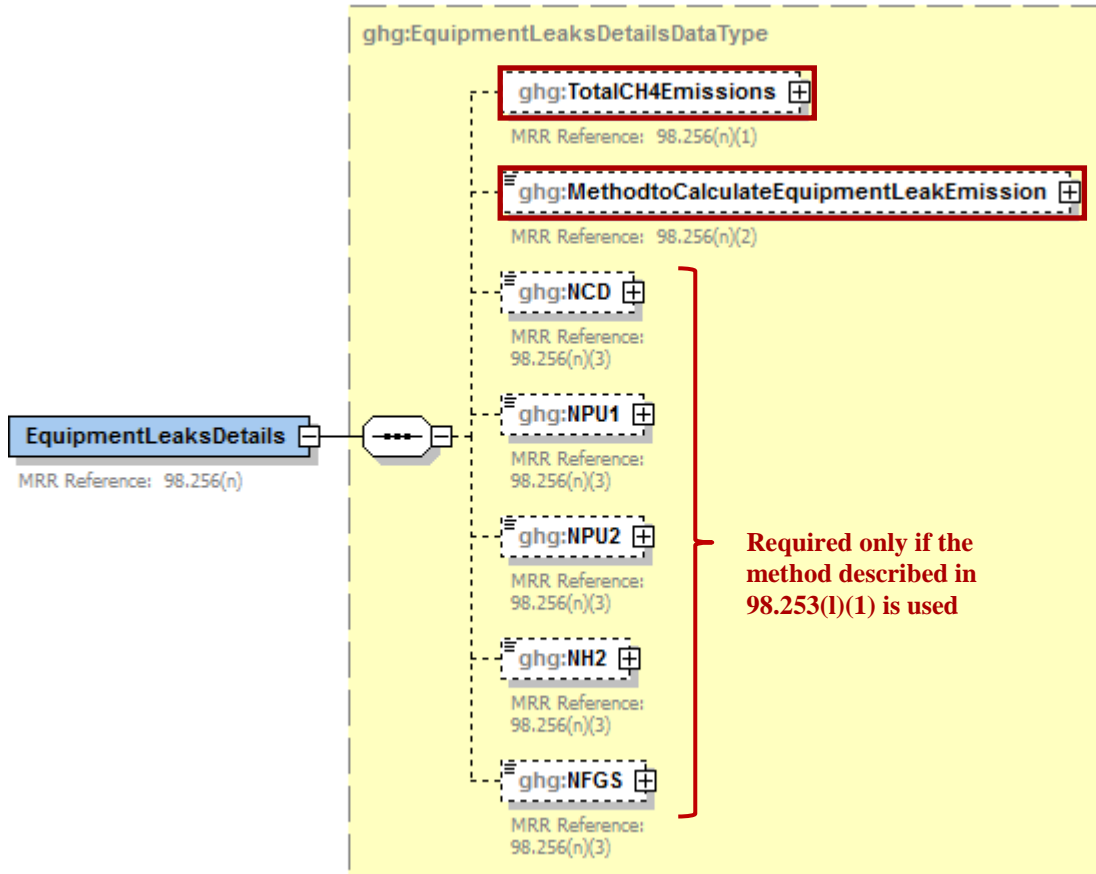

Note: Data elements boxed in red are required. Please see page 4 of this document for more information on conditionally required elements.

Method Used to Calculate CH₄ Emissions

You must specify the method used to calculate the CH₄ emissions from the facility's equipment leaks:

- Use process-specific methane composition data and any of the emission estimation procedures provided in the Protocol for Equipment Leak Emissions Estimates (EPA-453/R-95-017, NTIS PB96-175401) [98.253(1)(1)]
- Use Equation Y-21 [98.253(1)(2)]

Process-specific Methane Composition Data Method Summary and Result

Conditionally Required: If you use the process-specific methane composition data method to determine the cumulative CH₄ emissions from equipment leaks, then you must also report the following information:

- Cumulative number of catalytic cracking units, coking units (delayed or fluid), hydrocracking and full-range distillation columns (including depropanizer and debutanizer distillation columns) at the facility
- Cumulative number of hydrotreating/hydrorefining units, catalytic reforming units and visbreaking units at the facility
- Total number of hydrogen plants at the facility
- Total number of fuel gas systems at the facility
- Number of atmospheric crude oil distillation columns at the facility

Equation Y-21

If you use Equation Y-21 to calculate the cumulative CH₄ emissions from equipment leaks, you can download the Y-21 spreadsheet from the e-GGRT help site or use the following information:

$$\text{CH}_4 = (0.4 \times N_{\text{CD}}) + (0.2 \times N_{\text{PU1}}) + (0.1 \times N_{\text{PU2}}) + (4.3 \times N_{\text{H2}}) + (6 \times N_{\text{FGS}})$$

Where:

CH ₄	=	Annual methane emissions from equipment leaks (metric tons/year)
N _{CD}	=	Number of atmospheric crude oil distillation columns at the facility.
N _{PU1}	=	Cumulative number of catalytic cracking units, coking units (delayed or fluid), hydrocracking and full-range distillation columns (including depropanizer and debutanizer distillation columns) at the facility.
N _{PU2}	=	Cumulative number of hydrotreating/hydrorefining units, catalytic reforming units and visbreaking units at the facility.
N _{H2}	=	Total number of hydrogen plants at the facility.
N _{FGS}	=	Total number of fuel gas systems at the facility.

Table 49
Equipment Leaks Details Data Element Definitions

Data Element Name	Description
EquipmentLeaksDetails	Parent Element
TotalCH4Emissions	The cumulative annual CH ₄ emissions in metric tons from equipment leaks. Report the value in the child data element CalculatedValue . Set the units of measure to "Metric Tons" in the attribute massUOM . [98.256(n)(1)]
MethodtoCalculateEquipmentLeakEmission	The method used to calculate the reported equipment leak emissions as either that described in 98.253(1)(1) or (1)(2). [98.256(n)(2)] Below is the list of allowable values. 98.253(1)(1) method 98.253(1)(2) method
NCD	Conditionally Required: The number of atmospheric crude oil distillation columns at the facility (integer). Report if electing to use the 98.253(1)(1) method. [98.256(n)(3)]

Data Element Name	Description
NPU1	Conditionally Required: The cumulative number of catalytic cracking units, coking units (delayed or fluid), hydrocracking and full-range distillation columns (including depropanizer and debutanizer distillation columns) at the facility (integer). Report if electing to use the 98.253(l)(1) method. [98.256(n)(3)]
NPU2	Conditionally Required: The cumulative number of hydrotreating/hydrorefining units, catalytic reforming units and visbreaking units at the facility (integer). Report if electing to use the 98.253(l)(1) method. [98.256(n)(3)]
NH2	Conditionally Required: The total number of hydrogen plants at the facility (integer). Report if electing to use the 98.253(l)(1) method. [98.256(n)(3)]
NFGS	Conditionally Required: The total number of fuel gas systems at the facility (integer). Report if electing to use the 98.253(l)(1) method. [98.256(n)(3)]

**XML Excerpt 47
Example for Equipment Leaks**

```

<ghg:EquipmentLeaksDetails>
  <ghg:TotalCH4Emissions massUOM="Metric Tons">
    <ghg:CalculatedValue>213.24</ghg:CalculatedValue>
  </ghg:TotalCH4Emissions>
  <ghg:MethodtoCalculateEquipmentLeakEmission>98.253(l)(1) method</ghg:MethodtoCalculateEquipmentLeakEmission>
  <ghg:NCD>55</ghg:NCD>
  <ghg:NPU1>11</ghg:NPU1>
  <ghg:NPU2>22</ghg:NPU2>
  <ghg:NH2>33</ghg:NH2>
  <ghg:NFGS>44</ghg:NFGS>
</ghg:EquipmentLeaksDetails>
    
```

Note: The XML example above is presented here to demonstrate the concept of reporting the cumulative CH₄ emissions from equipment leaks if using 98.253(l)(1) method.

11.0 Storage Tanks

Required Subpart-Level Summary Data

For petroleum refinery sources required to report under Subpart Y, you are required to report the cumulative annual CH₄ emissions (in metric tons) for all storage tanks and the methods used to calculate the reported storage tank emissions. The cumulative annual CH₄ emissions and calculation methods used must be reported separately based on whether or not the storage tank was used to process unstabilized crude oil. If you did not receive either stabilized or unstabilized crude, that must be reported.

11.1 Details for Storage Tanks Used to Process Stabilized Crude

Figure 49
Storage Tanks (Stabilized Crude) Schema Diagram



Note: Data elements boxed in red are required. Please see page 4 of this document for more information on conditionally required elements.

Conditionally Required: Method Used to Calculate CH₄ Emissions

If the facility did receive stored liquids other than unstabilized crude oil during the reporting year, you must report the CH₄ emissions and specify the method used to calculate the CH₄ emissions from storage tanks other than those processing unstabilized crude oil [98.256(o)(2)(i)]:

- AP-42 - Section 7.1 of the AP-42: “Compilation of Air Pollutant Emission Factors, Volume 1: Stationary Point and Area Sources” (incorporated by reference, see 98.7)
- Use Equation Y-22

Equation Y-22

If you use Equation Y-22 to calculate the cumulative CH₄ emissions from all storage tanks other than those processing unstabilized crude oil, you can download the Y-22 spreadsheet from the e-GGRT help site or use the following information:

$$CH_4 = 0.1 \times Q_{Ref}$$

Where:

- CH₄ = Annual methane emissions from storage tanks (metric tons/year).
- 0.1 = Default emission factor for storage tanks (metric ton CH₄/MMbbl).
- Q_{Ref} = Quantity of crude oil plus the quantity of intermediate products received from off site that are processed at the facility (MMbbl/year).

You must indicate whether or not the facility received unstabilized crude oil during the reporting year.

**Table 50
Storage Tanks (Stabilized Crude) Data Element Definitions**

Data Element Name	Description
StorageTankDetails	Parent Element
StabilizedCrudeTotalCH4Emissions	Conditionally Required: If the facility did receive stored liquids other than unstabilized crude oil during the reporting year, report the cumulative annual CH ₄ emissions from all storage tanks (stored liquids), except for those used to process unstabilized crude oil. Report the value in the child data element CalculatedValue . Set the units of measure to “Metric Tons” in the attribute massUOM . [98.256(o)(1)]
StabilizedCrudeCalculationMethod	Conditionally Required: If the facility did receive stored liquids other than unstabilized crude oil during the reporting year, report the method used to calculate the reported storage tank emissions for storage tanks other than those processing unstabilized crude. Below is the list of allowable values. [98.256(o)(2)(i)] AP-42 Equation Y-22
isStablizedCrudeReceivedStoredIndicator	An indication (Y/N) of whether the facility received stored liquids other than unstabilized crude oil during the reporting year. [98.256(o)]

XML Excerpt 48 Example for Storage Tanks (Stabilized Crude)

```
<ghg:StorageTankDetails>
  <ghg:StabilizedCrudeTotalCH4Emissions massUOM="Metric Tons">
    <ghg:CalculatedValue>235.67</ghg:CalculatedValue>
  </ghg:StabilizedCrudeTotalCH4Emissions>
  <ghg:StabilizedCrudeCalculationMethod>Equation Y-22</ghg:StabilizedCrudeCalculationMethod>
  <ghg:isStablizedCrudeReceivedStoredIndicator>Y</ghg:isStablizedCrudeReceivedStoredIndicator>
</ghg:StorageTankDetails>
```

Note: The XML example above is presented here to demonstrate the concept of reporting emissions data for storage tanks other than those processing unstabilized crude oil.

11.2 Details for Storage Tanks Used to Process Unstabilized Crude

Figure 50
Storage Tanks (Unstabilized Crude) Schema Diagram



Note: Data elements boxed in red are required. Please see page 4 of this document for more information on conditionally required elements.

Figure 51
Unstabilized Methane Composition Method Details Schema Diagram

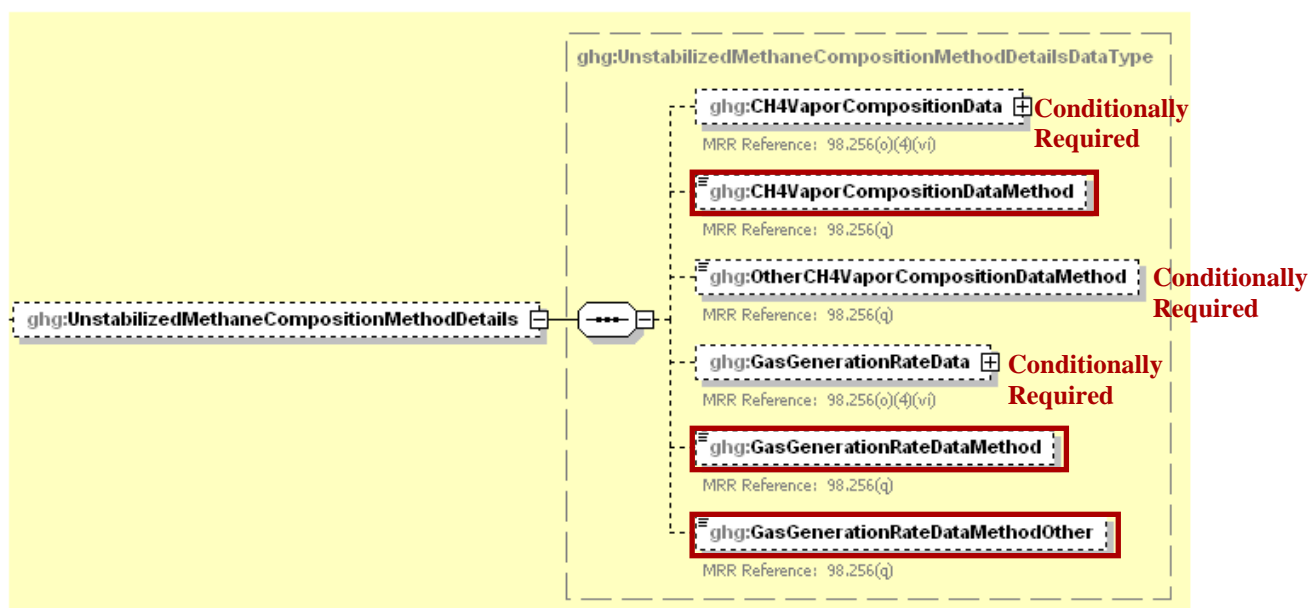

Note: Data elements boxed in red are required. Please see page 4 of this document for more information on conditionally required elements.

Note: You do not need to calculate CH₄ emissions from storage tanks that meet any of the following descriptions:

- Units permanently attached to conveyances such as trucks, trailers, rail cars, barges, or ships;
- Pressure vessels designed to operate in excess of 204.9 kilopascals and without emissions to the atmosphere;
- Bottoms receivers or sumps;
- Vessels storing wastewater; or
- Reactor vessels associated with a manufacturing process unit.

Conditionally Required: Method Used to Calculate CH₄ Emissions

If you are reporting emissions for storage tanks that process unstabilized crude oil, you must report the CH₄ emissions and specify the method used to calculate the CH₄ emissions [98.256(o)(4)(i)]:

- Tank-specific methane composition data and direct measurement of gas generation rate
- Use Equation Y-23

You must indicate whether or not the facility received unstabilized crude oil during the reporting year.

Conditionally Required: Mole Fraction Basis

Regardless of the method used to calculate CH₄ emissions, you are required to report the basis for the average mole fraction of CH₄ in the vent gas from the unstabilized crude oil storage tank. [98.256(o)(6)]:

- Equation Y-23 default
- Measurement data
- Product knowledge
- Other (specify)

Conditionally Required: Tank-Specific Methane Composition Data Method Summary and Result

If you use the tank-specific methane composition data method to determine the cumulative CH₄ emissions from storage tanks processing unstabilized crude oil, then you must also report the following information:

- Cumulative CH₄ emissions from unstabilized crude oil storage in metric tons
- Method used to measure tank-specific methane composition in the vapor
- **Conditionally Required:** If measured, the number of hours missing that data procedures were used to measure tank-specific methane composition
- Method used to measure the gas generation rate
- Specification of the procedures or method used to measure the gas generation rate
- **Conditionally Required:** If measured, the number of hours that missing data procedures were used to measure the gas generation rate

Equation Y-23

If you use Equation Y-23 to calculate the annual CH₄ emissions from the storage of unstabilized crude oil, you can download the Y-23 spreadsheet from the e-GGRT help site or use the following information:

$$CH_4 = (995,000 \times Q_{un} \times \Delta P) \times MF_{CH_4} \times \frac{16}{MVC} \times 0.001$$

Where:

CH ₄	=	Annual methane emissions from storage tanks (metric tons/year).
Q _{un}	=	Quantity of unstabilized crude oil received at the facility (MMbbl/year).
ΔP	=	Pressure differential from the previous storage pressure to atmospheric pressure (pounds per square inch, psi).
MF _{CH₄}	=	Average mole fraction of CH ₄ in vent gas from the unstabilized crude oil storage tanks from facility measurements (kg-mole CH ₄ /kg-mole gas); use 0.27 as a default if measurement data are not available.
995,000	=	Correlation Equation factor (scf gas per MMbbl per psi)
16	=	Molecular weight of CH ₄ (kg/kg-mole).
MVC	=	Molar volume conversion factor (849.5 scf/kg-mole at 68 °F and 14.7 psia or 836.6 scf/kg-mole at 60 °F and 14.7 psia).
0.001	=	Conversion factor (metric ton/kg).

Table 51
Storage Tanks (Unstabilized Crude) Data Element Definitions

Data Element Name	Description
UnStabilizedCrudeTotalCH4Emissions	Conditionally Required: If the facility did receive unstabilized crude oil during the reporting year, report the cumulative annual CH ₄ emissions from storage tanks used to process unstabilized crude oil storage. Report the value in the child data element CalculatedValue . Set the units of measure to "Metric Tons" in the attribute massUOM . [98.256(o)(3)]

Data Element Name	Description
UnStabilizedCrudeCalculationMethod	<p>Conditionally Required: If the facility did receive unstabilized crude oil during the reporting year, report the method used to calculate the reported unstabilized crude oil storage tank emissions. [98.256(o)(4)(i)] Below is the list of allowable values.</p> <p>Tank-specific methane composition data and direct measurement of gas generation rate Equation Y-23</p>
isUnStablizedCrudeReceivedStoredIndicator	<p>An indication (Y/N) of whether the facility received unstabilized crude oil during the reporting year. [98.256(o)]</p>
UnStabilizedCrudeBasisforMoleFraction	<p>Conditionally Required: If the facility did receive unstabilized crude oil during the reporting year, report the basis for the average mole fraction of CH₄ in vent gas from all unstabilized crude oil storage tanks. [98.256(o)(6)] Below is the list of allowable values.</p> <p>Equation Y-23 default Measurement data Product knowledge Other (specify)</p>
OtherUnStabilizedCrudeBasisforMoleFraction	<p>Conditionally Required: Specify the basis for the mole fraction if not listed above.</p>
UnstabilizedMethaneCompositionMethodDetails	<p>Parent Element (Conditionally Required): A collection of data elements to capture CH₄ vapor data. Report this data if the tank-specific methane composition data method was used to determine the cumulative CH₄ emissions from storage tanks processing unstabilized crude oil.</p>
CH4VaporCompositionData	<p>Conditionally Required: If measured, report the number of hours that missing data procedures were used to measure tank-specific CH₄ composition in the vapor in the child data element NumberOfTimesSubstituted. [98.3(c)(8)]</p>
CH4VaporCompositionDataMethod	<p>Specify the method used to measure tank-specific CH₄ composition in the vapor. [98.256(q)] Below is the list of allowable values.</p> <p>Measurement data Product knowledge Other (specify)</p>
OtherCH4VaporCompositionDataMethod	<p>Conditionally Required: Specify the method used to measure tank-specific CH₄ composition in the vapor if not listed above.</p>

Data Element Name	Description
GasGenerationRateData	Conditionally Required: If measured, report the number of hours that missing data procedures were used to measure the gas generation rate in the child data element NumberOfTimesSubstituted . [98.3(c)(8)]
GasGenerationRateDataMethod	The method used to measure the gas generation rate. [98.256(q)] Below is the list of allowable values. Procedures specified by flow meter manufacturer Method published by a consensus-based standards organization
GasGenerationRateDataMethodOther	The specification of the procedures or method used to measure the gas generation rate. [98.256(q)]

XML Excerpt 49
Example for Storage Tanks (Unstabilized Crude)

```

<ghg:UnStabilizedCrudeTotalCH4Emissions massUOM="Metric Tons">
  <ghg:CalculatedValue>190.0</ghg:CalculatedValue>
</ghg:UnStabilizedCrudeTotalCH4Emissions>
<ghg:UnStabilizedCrudeCalculationMethod>Tank-specific methane composition data and direct measurement of
gas generation rate</ghg:UnStabilizedCrudeCalculationMethod>
<ghg:isUnStabilizedCrudeReceivedStoredIndicator>Y</ghg:isUnStabilizedCrudeReceivedStoredIndicator>
<ghg:UnStabilizedCrudeBasisforMoleFraction>Product knowledge</ghg:UnStabilizedCrudeBasisforMoleFraction>
<ghg:UnstabilizedMethaneCompositionMethodDetails>
<ghg:CH4VaporCompositionData>
  <ghg:NumberOfTimesSubstituted>23</ghg:NumberOfTimesSubstituted>
</ghg:CH4VaporCompositionData>
<ghg:CH4VaporCompositionDataMethod>Measurement data</ghg:CH4VaporCompositionDataMethod>
<ghg:GasGenerationRateData>
  <ghg:NumberOfTimesSubstituted>100</ghg:NumberOfTimesSubstituted>
</ghg:GasGenerationRateData>
<ghg:GasGenerationRateDataMethod>Procedures specified by flow meter manufacturer</ghg:GasGenerationRateDataMethod>
<ghg:GasGenerationRateDataMethodOther>Method H</ghg:GasGenerationRateDataMethodOther>
</ghg:UnstabilizedMethaneCompositionMethodDetails>
</ghg:StorageTankDetails>

```

Note: The XML example above is presented here to demonstrate the concept of reporting emissions data for storage tanks that process unstabilized crude oil calculated using the tank-specific methane composition data method.

12.0 Loading Operations

Required Subpart-Level Summary Data

For petroleum refinery sources required to report under Subpart Y, you are required to report the cumulative methane (CH₄) emissions for all loading operations. **Note:** A zero must be entered for facilities that have no materials with a vapor-phase CH₄ concentration of 0.5 volume percent or greater.

Figure 52
Loading Operations Details Schema Diagram

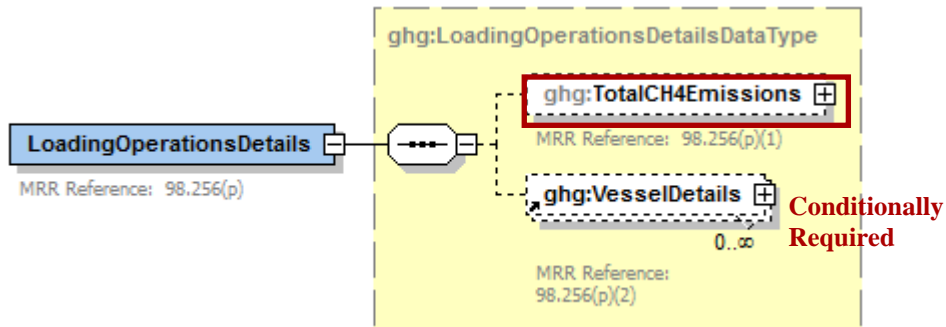

Note: Data elements boxed in red are required.

Conditionally Required: You must also specify each type of vessel loaded during the reporting year with one or more materials containing a vapor-phase concentration of CH₄ of 0.5 volume percent or greater.

- For each such vessel, you must report the type of each material containing a vapor-phase concentration of CH₄ of 0.5 volume percent or greater.
- For each material for each vessel type, report the type of control system used to reduce emissions from the loading of the material.

Figure 53
Vessel Details Schema Diagram

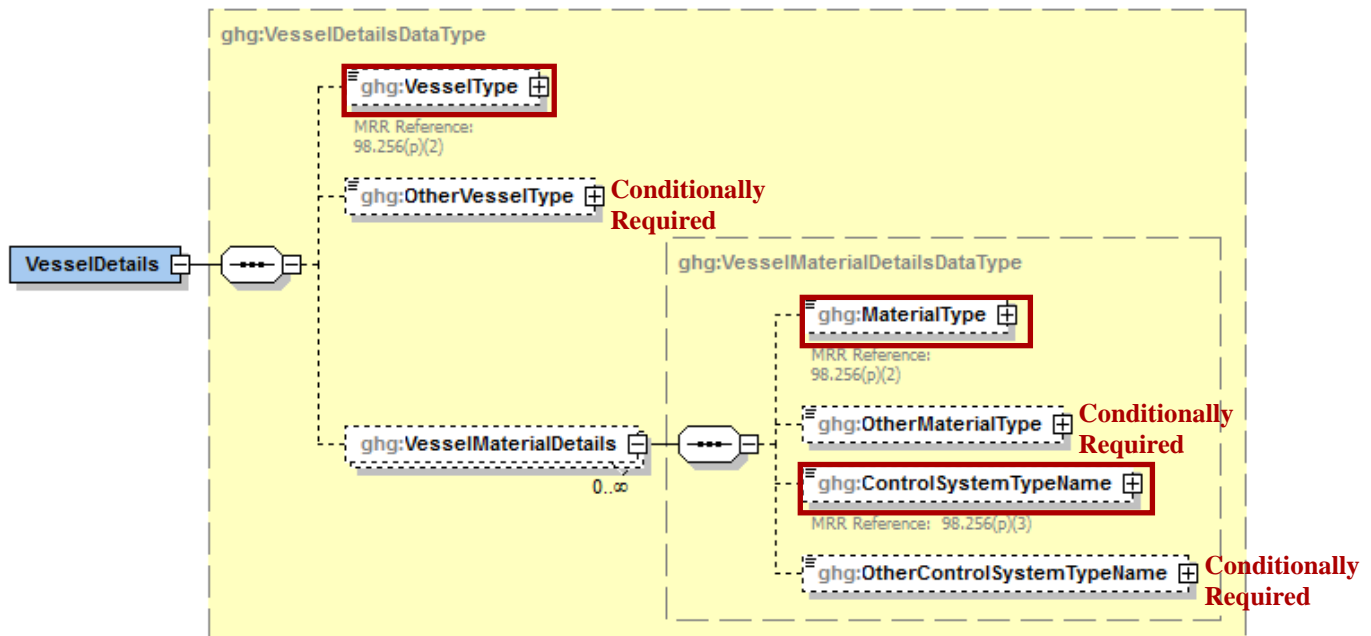

Note: Data elements boxed in red are required. Please see page 4 of this document for more information on conditionally required elements.

Table 52
Loading Operations Details Data Element Definitions

Data Element Name	Description
LoadingOperationsDetails	Parent Element
TotalCH4Emissions	<p>The cumulative annual CH₄ emissions (in metric tons of CH₄) for loading operations. Report the value in the child data element CalculatedValue. Set the units of measure to “Metric Tons” in the attribute massUOM. Note: A zero must be entered for facilities that have no materials with a vapor-phase CH₄ concentration of 0.5 volume percent or greater. [98.256(p)(1)]</p>
VesselDetails	Parent Element (Conditionally Required)
VesselType	<p>The type of each vessel used to transport material(s) containing an equilibrium vapor-phase CH₄ concentration of at least 0.5 percent during the reporting year. [98.256(p)(2)] Below is the list of allowable values.</p> <ul style="list-style-type: none"> Ship or ocean-going vessel Barge Railcar Tank truck Container (e.g., 55-gallon drum) Other (specify)
OtherVesselType	<p>Conditionally Required: Specify each type of vessel not listed above that was used to transport material containing a vapor-phase concentration of 0.5 volume percent or greater.</p>
VesselMaterialDetails	<p>Parent Element: A collection of data element containing details about the materials loaded. Report a separate VesselMaterialDetails record for each type of material loaded.</p>
MaterialType	<p>For the specified vessel type, report the type of each material containing a vapor-phase CH₄ concentration of 0.5 volume percent or greater. [98.256(p)(2)] Below is the list of allowable values.</p> <ul style="list-style-type: none"> Unstabilized crude oil Stabilized crude oil Still gas or refinery fuel gas LPG (propane/butane) Ethylene Oxygenates Naphtha Gasoline or gasoline blending stocks other than oxygenates Other (specify)
OtherMaterialType	<p>Conditionally Required: Specify each type of material not listed above that contained a vapor-phase concentration of CH₄ of 0.5 volume percent or greater.</p>

Data Element Name	Description
ControlSystemTypeName	<p>The type of control system used to reduce emissions from the loading of the specified material. [98.256(p)(3)] Below is the list of allowable values.</p> <ul style="list-style-type: none"> Submerged loading or bottom filling only; no other control system Vapor balancing Thermal or catalytic incinerator/oxidizer Flare Carbon adsorber Condenser Oil scrubber None Other (specify)
OtherControlSystemTypeName	<p>Conditionally Required: Specify each type of control system used not listed above that was used to reduce emissions from the loading of the material.</p>

XML Excerpt 50
Example for Loading Operations Details

```

<ghg>LoadingOperationsDetails>
  <ghg>TotalCH4Emissions massUOM="Metric Tons">
    <ghg:CalculatedValue>123.65</ghg:CalculatedValue>
  </ghg>TotalCH4Emissions>
  <ghg:VesselDetails>
    <ghg:VesselType>Barge</ghg:VesselType>
    <ghg:VesselMaterialDetails>
      <ghg:MaterialType>Still gas or refinery fuel gas</ghg:MaterialType>
      <ghg:ControlSystemTypeName>Thermal or catalytic incinerator/oxidizer</ghg:ControlSystemTypeName>
    </ghg:VesselMaterialDetails>
    <ghg:VesselMaterialDetails>
      <ghg:MaterialType>Oxygenates</ghg:MaterialType>
      <ghg:ControlSystemTypeName>Condenser</ghg:VesselMaterialDetails>
    </ghg:VesselMaterialDetails>
  </ghg:VesselDetails>
  <ghg:VesselDetails>
    <ghg:VesselType>Railcar</ghg:VesselType>
    <ghg:VesselMaterialDetails>
      <ghg:MaterialType>Ethylene</ghg:MaterialType>
      <ghg:ControlSystemTypeName>Oil scrubber</ghg:ControlSystemTypeName>
    </ghg:VesselMaterialDetails>
  </ghg:VesselDetails>
</ghg>LoadingOperationsDetails>

```

Note: The XML example above is presented here to demonstrate the concept of reporting the cumulative CH₄ emissions from loading operations. In the example above, there are two vessels, a barge and a railcar. The barge transported two types of material containing a vapor-phase CH₄ concentration of at least 0.5 percent and the railcar contained a single type.

13.0 Tier 4 CEMS Information

Conditionally Required Unit-Level Data

This section describes the emissions information that must be reported if the following types of process units were monitored by a continuous emissions monitoring system (CEMS) during the reporting year: Coke calcining units, Catalytic cracking units, Traditional fluid coking units, Fluid coking units with flexicoking design, Catalytic reforming units or Sulfur recovery plants.

Figure 54
Tier 4 CEMS Details Schema Diagram

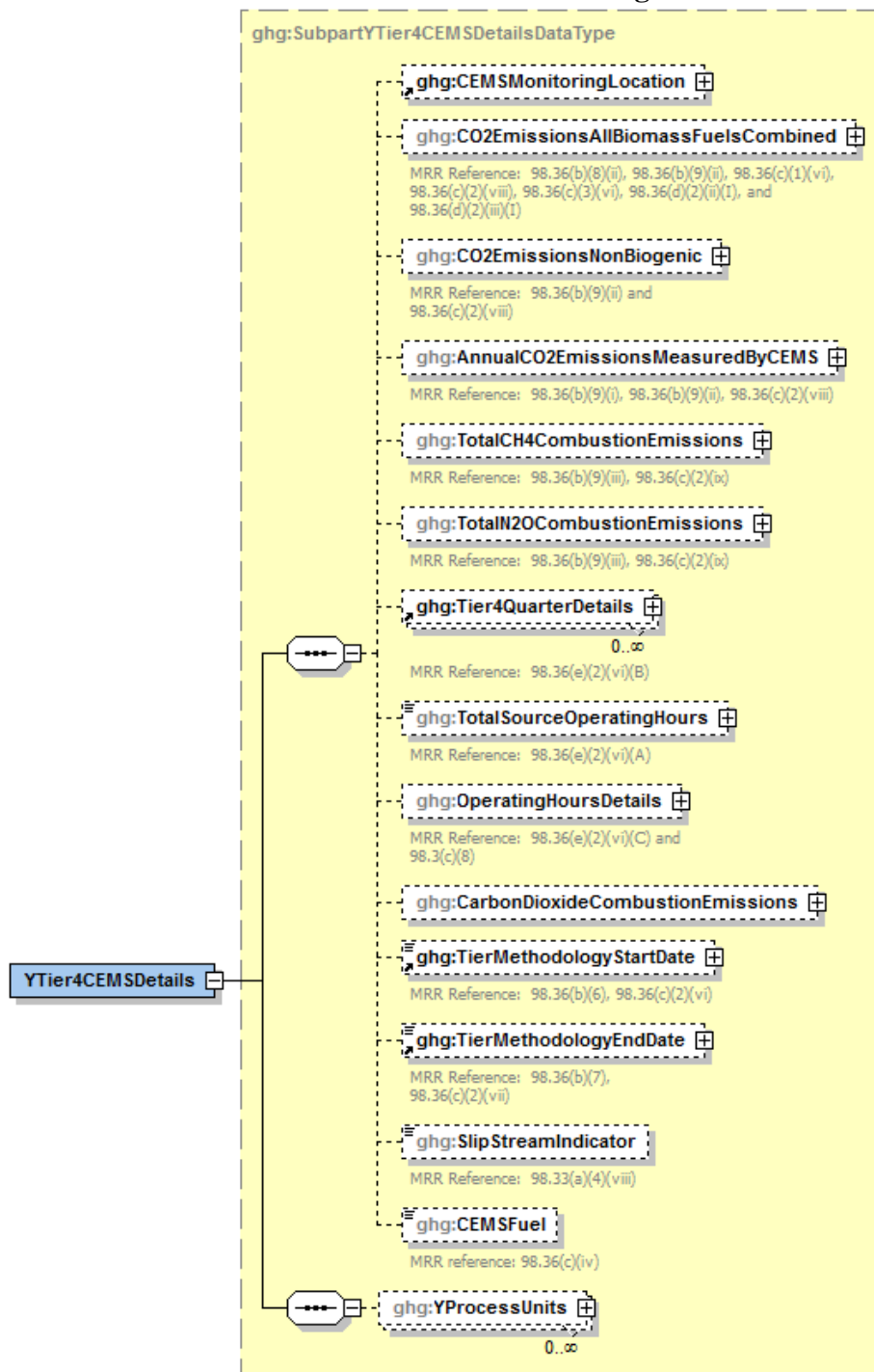

See the following figures for required data elements.

Figure 55
Tier 4 CEMS Location and Emissions Details Schema Diagram

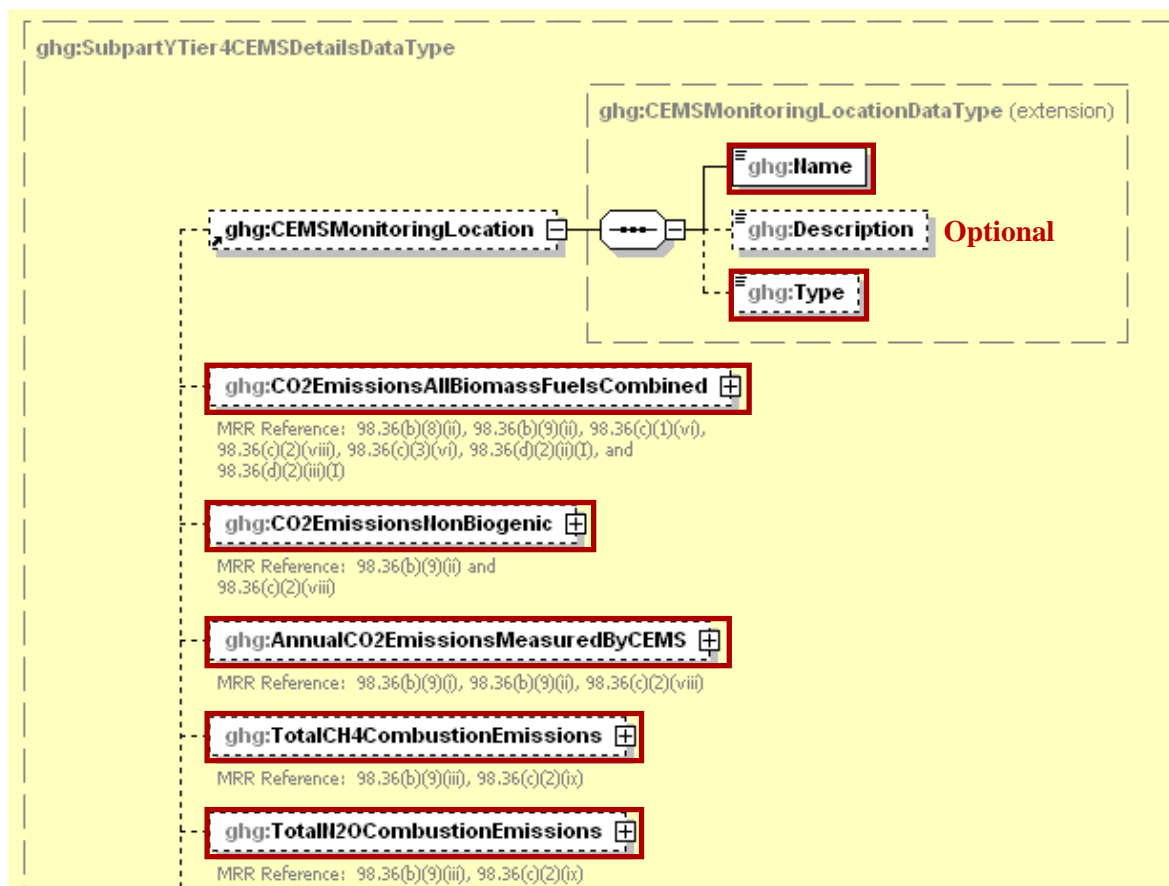

Note: Data elements boxed in red are required.

For Subpart Y, information on each CEMS monitoring location (CML) is required including the name [98.36(c)(2)(i)], an optional description and the configuration type. For each CML identified by the facility, the facility must specify the configuration type from the following list:

- Single industrial process or process unit that exhausts to a dedicated stack.
- Multiple industrial processes or process units share a common stack.
- Industrial process or process unit shares a common stack with a Tier 4 stationary fuel combustion unit.

For each CEMS monitoring location identified, the following emissions data must be reported:

- The total annual biogenic CO₂ mass emissions from combustion of all biomass fuels combined [98.36(b)(9)(ii), 98.36(c)(2)(viii)]
- The total annual non-biogenic CO₂ mass emissions (i.e. CO₂ mass emissions from fossil fuels, sorbent use and process emissions) [98.36(b)(9)(ii), 98.36(c)(2)(viii)]
- The total annual CO₂ mass emissions (biogenic and non-biogenic) measured by the CEMS [98.36(b)(9)(i)-(ii), 98.36(c)(2)(viii)]
- The total annual CH₄ mass emissions derived from Equation C-10, in metric tons CH₄ [98.36(b)(9)(iii), 98.36(c)(2)(ix)]
- The total annual N₂O mass emissions derived from Equation C-10, in metric tons N₂O [98.36(b)(9)(iii), 98.36(c)(2)(ix)]

Table 53
Tier 4 CEMS Location and Emissions Details Data Element Definitions

Data Element Name	Description
YTier4CEMSDetails	Parent Element (Conditionally Required): A collection of data elements containing information about each CEMS monitoring location.
CEMSMonitoringLocation	<p>A collection of data elements containing the identity of a CEMS monitoring location. [98.36(c)(2)(i)] It includes the location's name in the child data element Name, an optional description in the child data element Description and configuration type in the child data element Type. Below is the list of allowable configuration types.</p> <p>Single process/process unit exhausts to dedicated stack Multiple processes/process units share common stack Process/stationary combustion units share common stack</p>
CO2EmissionsAllBiomassFuelsCombined	Total annual biogenic CO ₂ mass emissions for the specified CEMS monitoring location. [98.36(b)(9)(ii), 98.36(c)(2)(viii)] Report the value in the child data element CalculatedValue . Set the units of measure to “Metric Tons” in the attribute massUOM .
CO2EmissionsNonBiogenic	The total annual non-biogenic CO ₂ mass emissions for the specified CEMS monitoring location. [98.36(b)(9)(ii), 98.36(c)(2)(viii)] Report the value in the child data element CalculatedValue . Set the units of measure to “Metric Tons” in the attribute massUOM .
AnnualCO2EmissionsMeasuredByCEMS	The total annual CO ₂ mass emissions measured by the CEMS at the specified CEMS monitoring location. [98.36(b)(9)(i)-(ii), 98.36(c)(2)(viii)] Report the value in the child data element CalculatedValue . Set the units of measure to “Metric Tons” in the attribute massUOM .
TotalCH4CombustionEmissions	The annual CH ₄ mass emissions measured at the specified CEMS monitoring location during the reporting year calculated using Equation C-10 expressed in mass of CH ₄ . [98.36(b)(9)(iii), 98.36(c)(2)(ix)] Report the value in the child data element CalculatedValue . Set the units of measure to “Metric Tons” in the attribute massUOM .
TotalN2OCombustionEmissions	The annual N ₂ O mass emissions at the specified CEMS monitoring location during the reporting year calculated using Equation C-10 expressed in mass of N ₂ O. [98.36(b)(9)(iii), 98.36(c)(2)(ix)] Report the value in the child data element CalculatedValue . Set the units of measure to “Metric Tons” in the attribute massUOM .

XML Excerpt 51 Example for Tier 4 CEMS Location and Emissions Details

```

ghg:YTier4CEMSDetails>
  <ghg:CEMSMonitoringLocation>
    <ghg:Name>CS- Location 1</ghg:Name>
    <ghg:Description>Northwest</ghg:Description>
    <ghg:Type>Single process/process unit exhausts to dedicated stack</ghg:Type>
  </ghg:CEMSMonitoringLocation>
  <ghg:CO2EmissionsAllBiomassFuelsCombined massUOM="Metric Tons">
    <ghg:CalculatedValue>150.6</ghg:CalculatedValue>
  </ghg:CO2EmissionsAllBiomassFuelsCombined>
  <ghg:CO2EmissionsNonBiogenic massUOM="Metric Tons">
    <ghg:CalculatedValue>1400.2</ghg:CalculatedValue>
  </ghg:CO2EmissionsNonBiogenic>
  <ghg:AnnualCO2EmissionsMeasuredByCEMS massUOM="Metric Tons">
    <ghg:CalculatedValue>1500.7</ghg:CalculatedValue>
  </ghg:AnnualCO2EmissionsMeasuredByCEMS>
  <ghg>TotalCH4CombustionEmissions massUOM="Metric Tons">
    <ghg:CalculatedValue>250.44</ghg:CalculatedValue>
  </ghg>TotalCH4CombustionEmissions>
  <ghg>TotalN2OCombustionEmissions massUOM="Metric Tons">
    <ghg:CalculatedValue>350.851</ghg:CalculatedValue>
  </ghg>TotalN2OCombustionEmissions>
    
```

Note: The code excerpt above is presented here to demonstrate the concept of reporting CEMS monitoring location details and measured greenhouse gas emissions.

Figure 56 Tier 4 CEMS Quarter and Additional Details Schema Diagram

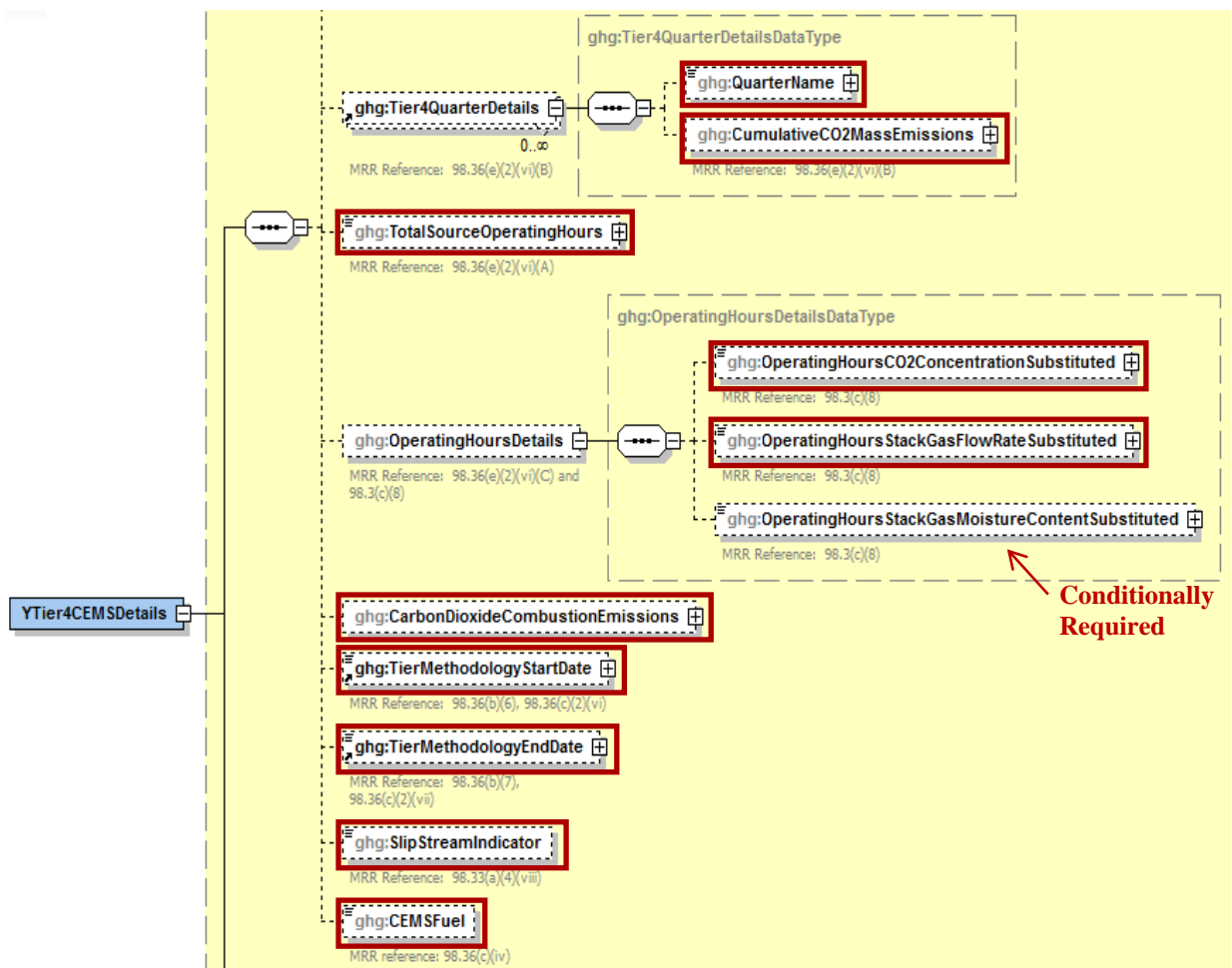

Note: Data elements boxed in red are required. Please see page 4 of this document for more information on conditionally required elements.

For each quarter of the reporting year, the facility must provide the cumulative CO₂ mass emissions for each CML [98.36(e)(2)(vi)(B)].

The facility must provide the following additional information for each CML:

- The total number of source operating hours in the reporting year [98.36(e)(2)(vi)(A)]
- The total operating hours in which a substitute data value was used in the emissions calculations for the CO₂ concentration parameter [98.36(e)(2)(vi)(C), 98.3(c)(8)]
- The total operating hours in which a substitute data value was used in the emissions calculations for the stack gas flow rate parameter [98.36(e)(2)(vi)(C), 98.3(c)(8)]
- If moisture correction is required and a continuous moisture monitor is used, the total operating hours in which a substitute data value was used in the emissions calculations for the stack gas moisture content parameter [98.36(e)(2)(vi)(C), 98.3(c)(8)]
- The CO₂ emissions from the total annual CO₂ mass emissions (biogenic and non-biogenic) measured by the CEMS at the specified CML that are attributable to combustion
- The Tier 4 methodology start date [98.36(b)(6), 98.36(c)(2)(vi)]
- The Tier 4 methodology end date [98.36(b)(7), 98.36(c)(2)(vii)]
- Specify if emissions reported for the CEMS include emissions calculated according to 98.33(a)(4)(viii) for a slipstream that bypassed the CEMS [98.33(a)(4)(viii)]
- Each type of fuel combusted in the group of units during the reporting year [98.36(b)(4), 98.36(c)(2)(iv)]

Table 54
Tier 4 CEMS Quarter and Additional Details Data Element Definitions

Data Element Name	Description
Tier4QuarterDetails	Parent Element
QuarterName	The name of the quarter. Below is the list of allowable values. First Quarter Second Quarter Third Quarter Fourth Quarter
CumulativeCO2MassEmissions	The cumulative CO ₂ mass emissions for the specified CEMS monitoring location for the specified quarter of the reporting year. [98.36(e)(2)(vi)(B)] Report the value in the child data element CalculatedValue . Set the units of measure to “Metric Tons” in the attribute massUOM .
TotalSourceOperatingHours	The total number of source operating hours in the reporting year for the specified CEMS monitoring location. [98.36(e)(2)(vi)(A)]
OperatingHoursDetails	Parent Element
OperatingHoursCO2ConcentrationSubstituted	The total operating hours in which a substitute data value was used in the emissions calculations for the CO ₂ concentration parameter at the specified CEMS monitoring location. [98.36(e)(2)(vi)(C), 98.3(c)(8)]

Data Element Name	Description
OperatingHoursStackGasFlowRateSubstituted	The total operating hours in which a substitute data value was used in the emissions calculations for the stack gas flow rate parameter at the specified CEMS monitoring location. [98.36(e)(2)(vi)(C), 98.3(c)(8)]
OperatingHoursStackGasMoistureContentSubstituted	Conditionally Required: If moisture correction is required and a continuous moisture monitor is used, the total operating hours in which a substitute data value was used in the emissions calculations for the stack gas moisture content parameter at the specified CEMS monitoring location. [98.36(e)(2)(vi)(C), 98.3(c)(8)]
CarbonDioxideCombustionEmissions	CO ₂ emissions from the total annual CO ₂ mass emissions (biogenic and non-biogenic) measured by the CEMS at the specified CML that are attributable to combustion. [98.256(f)(6), 98.256(h)(6)] Report the value in the child data element MeasureValue . Set the units of measure to “Metric Tons” in the attribute massUOM .
TierMethodologyStartDate	The tier methodology start date for the specified CEMS monitoring location (YYYY-MM-DD). [98.36(b)(6), 98.36(c)(2)(vi)]
TierMethodologyEndDate	The tier methodology end date for the specified CEMS monitoring location (YYYY-MM-DD). [98.36(b)(7), 98.36(c)(2)(vii)]
SlipStreamIndicator	An indication (Y/N) that the emissions reported for the CEMS include emissions calculated according to 98.33(a)(4)(viii) for a slipstream that bypassed the CEMS. [98.33(a)(4)(viii)]
CEMSFuel	Each type of fuel combusted in the group of units during the reporting year. [98.36(b)(4), 98.36(c)(2)(iv)]

XML Excerpt 52 Example for Y Tier 4 CEMS Quarter and Additional Details

```

<ghg:Tier4QuarterDetails>
  <ghg:QuarterName>First Quarter</ghg:QuarterName>
  <ghg:CumulativeCO2MassEmissions massUOM="Metric Tons">
    <ghg:CalculatedValue>600.3</ghg:CalculatedValue>
  </ghg:CumulativeCO2MassEmissions>
</ghg:Tier4QuarterDetails>
<ghg:Tier4QuarterDetails>
  <ghg:QuarterName>Second Quarter</ghg:QuarterName>
  <ghg:CumulativeCO2MassEmissions massUOM="Metric Tons">
    <ghg:CalculatedValue>700.2</ghg:CalculatedValue>
  </ghg:CumulativeCO2MassEmissions>
</ghg:Tier4QuarterDetails>
<ghg:Tier4QuarterDetails>
  <ghg:QuarterName>Third Quarter</ghg:QuarterName>
  <ghg:CumulativeCO2MassEmissions massUOM="Metric Tons">
    <ghg:CalculatedValue>800.1</ghg:CalculatedValue>
  </ghg:CumulativeCO2MassEmissions>
</ghg:Tier4QuarterDetails>
<ghg:Tier4QuarterDetails>
  <ghg:QuarterName>Fourth Quarter</ghg:QuarterName>
  <ghg:CumulativeCO2MassEmissions massUOM="Metric Tons">
    <ghg:CalculatedValue>900.8</ghg:CalculatedValue>
  </ghg:CumulativeCO2MassEmissions>
</ghg:Tier4QuarterDetails>
<ghg>TotalSourceOperatingHours>8400</ghg>TotalSourceOperatingHours>
<ghg:OperatingHoursDetails>
  <ghg:OperatingHoursCO2ConcentrationSubstituted>450</ghg:OperatingHoursCO2ConcentrationSubstituted>
  <ghg:OperatingHoursStackGasFlowRateSubstituted>550</ghg:OperatingHoursStackGasFlowRateSubstituted>
  <ghg:OperatingHoursStackGasMoistureContentSubstituted>650</ghg:OperatingHoursStackGasMoistureContentSubstituted>
</ghg:OperatingHoursDetails>
<ghg:CarbonDioxideCombustionEmissions massUOM="Metric Tons">
  <ghg:MeasureValue>3452.1</ghg:MeasureValue>
</ghg:CarbonDioxideCombustionEmissions>
<ghg:TierMethodologyStartDate>2010-01-01</ghg:TierMethodologyStartDate>
<ghg:TierMethodologyEndDate>2010-12-31</ghg:TierMethodologyEndDate>
<ghg:SlipStreamIndicator>Y</ghg:SlipStreamIndicator>
<ghg:CEMSFuel>coal, coke, natural gas</ghg:CEMSFuel>
    
```

Note: The code excerpt above is presented here to demonstrate the concept of reporting Tier 4 CEMS details and quarterly data.

**Figure 57
Tier 4 CEMS Quarter and Additional Details Schema Diagram**

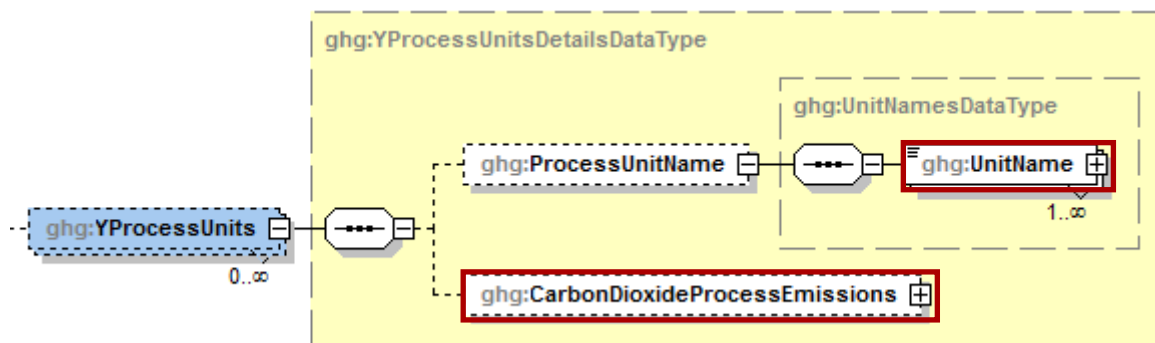

Note: Data elements boxed in red are required.

For each CML that is monitoring a Subpart Y petroleum refinery process unit, report the following for each process unit:

- The name/ID of the process unit monitored at the CML.
- The CO₂ emissions from the CML which are attributable to process CO₂ emissions from the process unit.

Table 55
Tier 4 CEMS Process Units Details Data Element Definitions

Data Element Name	Description
YProcessUnits	Parent Element: A collection of data elements for process units monitored at the specified CEMS monitoring location. Report each unit separately.
ProcessUnitName	Parent Element: A parent element for the identification of the process unit monitored at the specified CEMS monitoring location.
UnitName	The name of one process unit that is monitored at the specified CML. Use the same unit name as was used for "UnitIdentification". [98.256(f)(1), 98.256(h)(1), 98.256(i)(1)]
CarbonDioxideProcessEmissions	The CO ₂ emissions from the CML which are attributable to process CO ₂ emissions from the specified process unit. [98.256(f)(6), 98.256(h)(6), 98.256(i)(6)] Report the value in the child data element MeasureValue . Set the units of measure to "Metric Tons" in the attribute massUOM .

XML Excerpt 53
Example for Tier 4 CEMS Process Units Details

```

<ghg:YProcessUnits>
  <ghg:ProcessUnitName>
    <ghg:UnitName>CEMS-001</ghg:ProcessUnitName>
  </ghg:ProcessUnitName>
  <ghg:CarbonDioxideProcessEmissions massUOM="Metric Tons">
    <ghg:ghg:MeasureValue>123.4</ghg:MeasureValue>
  </ghg:CarbonDioxideProcessEmissions >
</ghg:YProcessUnits>
<ghg:YProcessUnits>
  <ghg:ProcessUnitName>
    <ghg:UnitName>CEMS-002</ghg:ProcessUnitName>
  </ghg:ProcessUnitName>
  <ghg:CarbonDioxideProcessEmissions massUOM="Metric Tons">
    <ghg:ghg:MeasureValue>567.8</ghg:MeasureValue>
  </ghg:CarbonDioxideProcessEmissions >
</ghg:YProcessUnits>
<ghg:YProcessUnits>
  <ghg:ProcessUnitName>
    <ghg:UnitName>CEMS-003</ghg:ProcessUnitName>
  </ghg:ProcessUnitName>
  <ghg:CarbonDioxideProcessEmissions massUOM="Metric Tons">
    <ghg:ghg:MeasureValue>901.2</ghg:MeasureValue>
  </ghg:CarbonDioxideProcessEmissions >
</ghg:YProcessUnits>
</ghg:YTier4CEMSDetails>
</ghg:SubPartY>

```

Note: The code excerpt above is presented here to demonstrate the concept of reporting Tier 4 CEMS process unit data.

14.0 Facility-Level Roll-up Emissions

Required Subpart-Level Summary Data

Each facility must report the following facility-level emission totals:

- Total CO₂ equivalent (CO₂e) emissions (excluding biogenic CO₂) aggregated across all direct emitter source categories (Subparts C-HH) associated with the facility.
- Total biogenic CO₂ emissions aggregated across all direct emitter source categories (Subparts C-HH) associated with the facility.

Each supplier must report the following supplier totals:

- Total CO₂e associated with products supplied aggregated across Subparts NN, OO and PP (as applicable). **Note:** Do not include Subpart LL and MM totals in this data element as these values are not being collected in e-GGRT.

Figure 58
Facility-Level Roll-up Emissions Schema Diagram

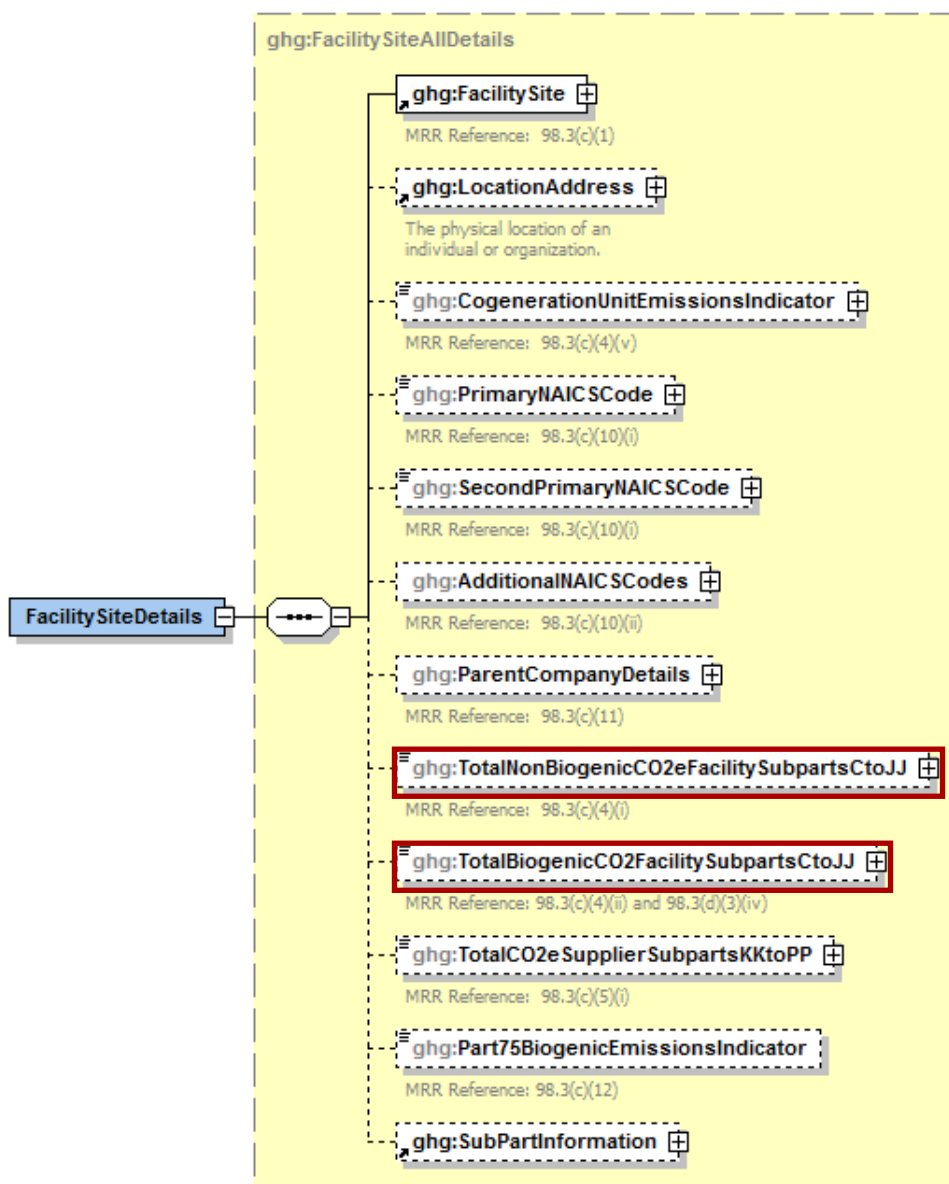

Note: Data elements boxed in red are required.

- 1) Add the total CO₂e value for Subpart Y in metric tons to the total CO₂e emissions (excluding biogenic CO₂) aggregated across all source category Subparts associated with the facility according to the following guidelines:
 - Add the value reported for Carbon Dioxide at the Subpart level.
 - Multiply the value reported for CH₄ at the Subpart level by the Global Warming Potential for CH₄ of 21, and add the resulting value.
 - Multiply the value reported for N₂O at the Subpart level by the Global Warming Potential for N₂O of 310, and add the resulting value.

- 2) Add the total annual biogenic CO₂ mass emissions in metric tons for each CML to the total biogenic CO₂ aggregated across all source category Subparts associated with the facility.

Note: You must follow the rounding rules found in [Table 1](#).

Table 56
Facility-Level Roll-up Emissions Data Element Definitions

Data Element Name	Description
TotalNonBiogenicCO2eFacilitySubpartsCtoJJ	Add the total CO ₂ e value for Subpart Y in metric tons to the total CO ₂ e emissions (excluding biogenic CO ₂) aggregated across all source category Subparts associated with the facility according to the guidelines above. Set the units of measure to “Metric Tons” in the attribute massUOM .
TotalBiogenicCO2FacilitySubpartsCtoJJ	Add the total annual biogenic CO ₂ value for Subpart Y in metric tons to the total biogenic CO ₂ emissions aggregated across all source category Subparts associated with the facility according to the guideline above. Set the units of measure to “Metric Tons” in the attribute massUOM .

XML Excerpt 54
Example for Facility-Level Roll-up Emissions

```
<ghg:TotalNonBiogenicCO2eFacilitySubpartsCtoJJ massUOM="Metric Tons">5110969.6</ghg:TotalNonBiogenicCO2eFacilitySubpartsCto JJ>
<ghg:TotalBiogenicCO2FacilitySubpartsCtoJJ massUOM="Metric Tons">3234.4</ghg:TotalBiogenicCO2FacilitySubpartsCtoJJ>
```

Note: The code excerpt above is presented here to demonstrate the concept of reporting facility level roll-up greenhouse gas emissions data.

IV. Appendix A – Sample XML Document for Subpart Y

(Note: Data values do not reflect an actual facility's emissions. Additional sample XML files for Subpart Y are posted on the e-GGRT help site. <http://www.ccdsupport.com/confluence/display/help/Additional+XML+Examples>)

```
<?xml version="1.0" encoding="UTF-8"?>
<ghg:GHG xsi:schemaLocation="http://www.exchangenetwork.net/schema/ghg/1 file:///L:/XML_Schema/GHG_Final_05062011/GHG_Final_v1.12.xsd"
xmlns:ghg="http://www.exchangenetwork.net/schema/ghg/1" xmlns:xsi="http://www.w3.org/2001/XMLSchema-instance">
  <ghg:SubmittalComment>Submitted by D. Rawler, Kenniston Enterprises</ghg:SubmittalComment>
  <ghg:FacilitySiteInformation>
    <ghg:ReportingYear>2011</ghg:ReportingYear>
    <ghg:FacilitySiteDetails>
      <ghg:FacilitySite>
        <ghg:FacilitySiteIdentifier>522948</ghg:FacilitySiteIdentifier>
        <ghg:FacilitySiteName>TEST Facility</ghg:FacilitySiteName>
      </ghg:FacilitySite>
      <ghg:LocationAddress>
        <ghg:LocationAddressText>12600 S. ANY STREET</ghg:LocationAddressText>
        <ghg:LocalityName>Houston</ghg:LocalityName>
        <ghg:StateIdentity>
          <ghg:StateCode>TX</ghg:StateCode>
        </ghg:StateIdentity>
        <ghg:AddressPostalCode>77004</ghg:AddressPostalCode>
      </ghg:LocationAddress>
      <ghg:CogenerationUnitEmissionsIndicator>N</ghg:CogenerationUnitEmissionsIndicator>
      <ghg:PrimaryNAICSCode>111110</ghg:PrimaryNAICSCode>
      <ghg:ParentCompanyDetails>
        <ghg:ParentCompany>
          <ghg:ParentCompanyLegalName>Soda Ash Corporation</ghg:ParentCompanyLegalName>
          <ghg:StreetAddress>108 Hillcrest Street</ghg:StreetAddress>
          <ghg:City>Sandpoint</ghg:City>
          <ghg:State>ID</ghg:State>
          <ghg:Zip>83864</ghg:Zip>
          <ghg:PercentOwnershipInterest>100.0</ghg:PercentOwnershipInterest>
        </ghg:ParentCompany>
      </ghg:ParentCompanyDetails>
      <ghg>TotalNonBiogenicCO2eFacilitySubpartsCtoJJ>5110969.6</ghg>TotalNonBiogenicCO2eFacilitySubpartsCtoJJ>
      <ghg>TotalBiogenicCO2FacilitySubpartsCtoJJ>3234.4</ghg>TotalBiogenicCO2FacilitySubpartsCtoJJ>
      <ghg>TotalCO2eSupplierSubpartsKKtoPP>0</ghg>TotalCO2eSupplierSubpartsKKtoPP>
      <ghg:SubPartInformation>
        <ghg:SubPartY>
          <ghg:GHGasInfoDetails>
            <ghg:GHGasName>Biogenic Carbon dioxide</ghg:GHGasName>
            <ghg:GHGasQuantity massUOM="Metric Tons">
              <ghg:CalculatedValue>3234.4</ghg:CalculatedValue>
            </ghg:GHGasQuantity>
          </ghg:GHGasInfoDetails>
          <ghg:GHGasInfoDetails>
            <ghg:GHGasName>Methane</ghg:GHGasName>
            <ghg:GHGasQuantity massUOM="Metric Tons">
              <ghg:CalculatedValue>89536.14</ghg:CalculatedValue>
            </ghg:GHGasQuantity>
          </ghg:GHGasInfoDetails>
          <ghg:GHGasInfoDetails>
            <ghg:GHGasName>Nitrous Oxide</ghg:GHGasName>
            <ghg:GHGasQuantity massUOM="Metric Tons">
```

```

    <ghg:CalculatedValue>156042.345</ghg:CalculatedValue>
  </ghg:GHGasQuantity>
</ghg:GHGasInfoDetails>
<ghg:GHGasInfoDetails>
  <ghg:GHGasName>Carbon Dioxide</ghg:GHGasName>
  <ghg:GHGasQuantity massUOM="Metric Tons">
    <ghg:CalculatedValue>298375.1</ghg:CalculatedValue>
  </ghg:GHGasQuantity>
</ghg:GHGasInfoDetails>
<ghg:FlareGasDetails>
  <ghg:FlareGasUnitDetails>
    <ghg:UnitIdentification>
      <ghg:UnitName>FL-003</ghg:UnitName>
      <ghg:UnitDescription>description text</ghg:UnitDescription>
      <ghg:UnitType>Flare</ghg:UnitType>
    </ghg:UnitIdentification>
    <ghg:FlareType>Unassisted</ghg:FlareType>
    <ghg:FlareService>Emergency only flare</ghg:FlareService>
    <ghg:EmissionsDetails>
      <ghg:CO2EmissionsCalculationMethod>98.253(b)(1)(ii)(A) - Equation Y-1a Gas Composition Monitored</ghg:CO2EmissionsCalculationMethod>
      <ghg:CO2Emissions massUOM="Metric Tons">
        <ghg:CalculatedValue>67989.8</ghg:CalculatedValue>
      </ghg:CO2Emissions>
      <ghg:CH4Emissions massUOM="Metric Tons">
        <ghg:CalculatedValue>55.68</ghg:CalculatedValue>
      </ghg:CH4Emissions>
      <ghg:N2OEmissions massUOM="Metric Tons">
        <ghg:CalculatedValue>22.897</ghg:CalculatedValue>
      </ghg:N2OEmissions>
    </ghg:EmissionsDetails>
    <ghg:FlareGasCarbonFractionBasis>Method 18 at 40 CFR part 60, appendix A-6</ghg:FlareGasCarbonFractionBasis>
    <ghg:Y2EquationDetails>
      <ghg:MeasurementPeriod>Daily</ghg:MeasurementPeriod>
      <ghg:AnnualVolumeofFlareGas volUOM="MMscf">
        <ghg:MeasureValue>3423.34533</ghg:MeasureValue>
        <ghg:NumberOfTimesSubstituted>60</ghg:NumberOfTimesSubstituted>
      </ghg:AnnualVolumeofFlareGas>
      <ghg:AnnualVolumeofFlareGasMethod>ASTM - D</ghg:AnnualVolumeofFlareGasMethod>
      <ghg:AnnualAverageHigherHeatingValue heatUOM="MMBtu/MMscf">
        <ghg:MeasureValue>230</ghg:MeasureValue>
        <ghg:NumberOfTimesSubstituted>55</ghg:NumberOfTimesSubstituted>
      </ghg:AnnualAverageHigherHeatingValue>
      <ghg:AnnualAverageHigherHeatingValueMethod>ASTM D240-02 (Reapproved 2007)</ghg:AnnualAverageHigherHeatingValueMethod>
      <ghg:FlareGasConditions>68 degrees F and 14.7 psia</ghg:FlareGasConditions>
      <ghg:HeatingValueConditions>60 degrees F and 14.7 psia</ghg:HeatingValueConditions>
    </ghg:Y2EquationDetails>
  </ghg:FlareGasUnitDetails>
</ghg:FlareGasUnitDetails>
  <ghg:UnitIdentification>
    <ghg:UnitName>FL-002</ghg:UnitName>
    <ghg:UnitType>Flare</ghg:UnitType>
  </ghg:UnitIdentification>
  <ghg:FlareType>Air-assisted</ghg:FlareType>
  <ghg:FlareService>Unit flare</ghg:FlareService>
  <ghg:EmissionsDetails>
    <ghg:CO2EmissionsCalculationMethod>98.253(b)(1)(ii)(A) - Equation Y-1b Gas Composition Monitored</ghg:CO2EmissionsCalculationMethod>
    <ghg:CO2Emissions massUOM="Metric Tons">
      <ghg:CalculatedValue>93673.2</ghg:CalculatedValue>
    </ghg:CO2Emissions>
  </ghg:EmissionsDetails>

```



```

    <ghg:CH4Emissions massUOM="Metric Tons">
      <ghg:CalculatedValue>7888.34</ghg:CalculatedValue>
    </ghg:CH4Emissions>
    <ghg:N2OEmissions massUOM="Metric Tons">
      <ghg:CalculatedValue>4567.376</ghg:CalculatedValue>
    </ghg:N2OEmissions>
  </ghg:EmissionsDetails>
  <ghg:FlareGasCarbonFractionBasis>ASTM D1946-90 (Reapproved 2006)</ghg:FlareGasCarbonFractionBasis>
  <ghg:Y1bEquationDetails>
    <ghg:MeasurementPeriod>Weekly</ghg:MeasurementPeriod>
    <ghg:AnnualVolumeofFlareGas volUOM="scf">
      <ghg:MeasureValue>11.3452</ghg:MeasureValue>
      <ghg:NumberOfTimesSubstituted>30</ghg:NumberOfTimesSubstituted>
    </ghg:AnnualVolumeofFlareGas>
    <ghg:AnnualVolumeofFlareGasMethod>ASTM - C</ghg:AnnualVolumeofFlareGasMethod>
    <ghg:AnnualAverageCarbonDioxideConcentration concentrationUOM="percent by volume or mole">
      <ghg:MeasureValue>0.75</ghg:MeasureValue>
      <ghg:NumberOfTimesSubstituted>1</ghg:NumberOfTimesSubstituted>
    </ghg:AnnualAverageCarbonDioxideConcentration>
    <ghg:AnnualAverageCarbonDioxideConcentrationMethod>UOP539-97</ghg:AnnualAverageCarbonDioxideConcentrationMethod>
    <ghg:TotalNumberOfCarbonCompounds>2</ghg:TotalNumberOfCarbonCompounds>
    <ghg:CompoundIdentifierDetails>
      <ghg:AnnualAverageConcentration concentrationUOM="percent by volume or mole">
        <ghg:MeasureValue>39</ghg:MeasureValue>
        <ghg:NumberOfTimesSubstituted>30</ghg:NumberOfTimesSubstituted>
      </ghg:AnnualAverageConcentration>
      <ghg:AnnualAverageConcentrationMethods>
        <ghg:AnnualAverageConcentrationMethod>Method 18 at 40 CFR part 60, appendix A-6</ghg:AnnualAverageConcentrationMethod>
        <ghg:AnnualAverageConcentrationMethod>UOP539-97</ghg:AnnualAverageConcentrationMethod>
      </ghg:AnnualAverageConcentrationMethods>
    </ghg:CompoundIdentifierDetails>
    <ghg:CompoundIdentifierDetails>
      <ghg:AnnualAverageConcentration concentrationUOM="percent by volume or mole">
        <ghg:MeasureValue>35</ghg:MeasureValue>
        <ghg:NumberOfTimesSubstituted>20</ghg:NumberOfTimesSubstituted>
      </ghg:AnnualAverageConcentration>
      <ghg:AnnualAverageConcentrationMethods>
        <ghg:AnnualAverageConcentrationMethod>ASTM D1945-03</ghg:AnnualAverageConcentrationMethod>
        <ghg:AnnualAverageConcentrationMethod>ASTM D2503-92 (Reapproved 2007)</ghg:AnnualAverageConcentrationMethod>
      </ghg:AnnualAverageConcentrationMethods>
    </ghg:CompoundIdentifierDetails>
  </ghg:Y1bEquationDetails>
</ghg:FlareGasUnitDetails>
<ghg:FlareGasUnitDetails>
  <ghg:UnitIdentification>
    <ghg:UnitName>FL-004</ghg:UnitName>
    <ghg:UnitDescription>flare test unit</ghg:UnitDescription>
    <ghg:UnitType>Flare</ghg:UnitType>
  </ghg:UnitIdentification>
  <ghg:FlareType>Unassisted</ghg:FlareType>
  <ghg:FlareService>Back-up flare</ghg:FlareService>
  <ghg:EmissionsDetails>
    <ghg:CO2EmissionsCalculationMethod>98.253(b)(1)(iii) - Equation Y-3 Start-up, Shutdown, Malfunction</ghg:CO2EmissionsCalculationMethod>
    <ghg:CO2Emissions massUOM="Metric Tons">
      <ghg:CalculatedValue>333.8</ghg:CalculatedValue>
    </ghg:CO2Emissions>
    <ghg:CH4Emissions massUOM="Metric Tons">
      <ghg:CalculatedValue>2342.08</ghg:CalculatedValue>
    </ghg:CH4Emissions>
  </ghg:EmissionsDetails>

```

```

    <ghg:N2OEmissions massUOM="Metric Tons">
      <ghg:CalculatedValue>434.111</ghg:CalculatedValue>
    </ghg:N2OEmissions>
  </ghg:EmissionsDetails>
</ghg:FlareGasCarbonFractionBasis>GPA 2261-00</ghg:FlareGasCarbonFractionBasis>
<ghg:Y3EquationDetails>
  <ghg:TotalNumberofSSEvents>43</ghg:TotalNumberofSSEvents>
</ghg:Y3EquationDetails>
</ghg:FlareGasUnitDetails>
<ghg:FlareGasUnitDetails>
  <ghg:UnitIdentification>
    <ghg:UnitName>FL-001</ghg:UnitName>
    <ghg:UnitDescription>Test Flare</ghg:UnitDescription>
    <ghg:UnitType>Flare</ghg:UnitType>
  </ghg:UnitIdentification>
  <ghg:FlareType>Steam assisted</ghg:FlareType>
  <ghg:FlareService>Unit flare</ghg:FlareService>
  <ghg:EmissionsDetails>
    <ghg:CO2EmissionsCalculationMethod>98.253(b)(1)(ii)(A) - Equation Y-1a Gas Composition Monitored</ghg:CO2EmissionsCalculationMethod>
    <ghg:CO2Emissions massUOM="Metric Tons">
      <ghg:CalculatedValue>47879.7</ghg:CalculatedValue>
    </ghg:CO2Emissions>
    <ghg:CH4Emissions massUOM="Metric Tons">
      <ghg:CalculatedValue>2345.22</ghg:CalculatedValue>
    </ghg:CH4Emissions>
    <ghg:N2OEmissions massUOM="Metric Tons">
      <ghg:CalculatedValue>3214.987</ghg:CalculatedValue>
    </ghg:N2OEmissions>
  </ghg:EmissionsDetails>
  <ghg:FlareGasCarbonFractionBasis>Engineering calculations</ghg:FlareGasCarbonFractionBasis>
  <ghg:Y1aEquationDetails>
    <ghg:MeasurementPeriod>Daily</ghg:MeasurementPeriod>
    <ghg:AnnualVolumeofFlareGas volUOM="scf">
      <ghg:MeasureValue>234.45689</ghg:MeasureValue>
      <ghg:NumberofTimesSubstituted>5</ghg:NumberofTimesSubstituted>
    </ghg:AnnualVolumeofFlareGas>
    <ghg:AnnualVolumeofFlareGasMethod>ASTM - A</ghg:AnnualVolumeofFlareGasMethod>
    <ghg:AnnualAverageMolecularWeight molewtUOM="kg/kg-mole">
      <ghg:MeasureValue>345.89</ghg:MeasureValue>
      <ghg:NumberofTimesSubstituted>109</ghg:NumberofTimesSubstituted>
    </ghg:AnnualAverageMolecularWeight>
    <ghg:AnnualAverageMolecularWeightMethod>ASTM D1945-03</ghg:AnnualAverageMolecularWeightMethod>
    <ghg:AnnualAverageMolecularWeightMethod>GPA 2261-00</ghg:AnnualAverageMolecularWeightMethod>
    <ghg:AnnualAverageMolecularWeightMethod>ASTM D2503-92 (Reapproved 2007)</ghg:AnnualAverageMolecularWeightMethod>
    <ghg:AnnualAverageCarbonContent carboncontentUOM="decimal fraction; kg carbon/kg flare gas">
      <ghg:MeasureValue>0.65</ghg:MeasureValue>
      <ghg:NumberofTimesSubstituted>3</ghg:NumberofTimesSubstituted>
    </ghg:AnnualAverageCarbonContent>
    <ghg:AnnualAverageCarbonContentMethod>ASTM D1945-03</ghg:AnnualAverageCarbonContentMethod>
    <ghg:AnnualAverageCarbonContentMethod>ASTM D1946-90 (Reapproved 2006)</ghg:AnnualAverageCarbonContentMethod>
    <ghg:AnnualAverageCarbonContentMethod>Chromatographic analysis: manufacturer's instructions</ghg:AnnualAverageCarbonContentMethod>
  </ghg:Y1aEquationDetails>
</ghg:FlareGasUnitDetails>
</ghg:FlareGasDetails>
<ghg:CrackingCokingReformingDetails>
  <ghg:CrackingCokingReformingUnitDetails>
    <ghg:UnitIdentification>
      <ghg:UnitName>CC-CEMS-001</ghg:UnitName>
      <ghg:UnitType>Fluid Catalytic Cracking Unit</ghg:UnitType>
    </ghg:UnitIdentification>
  </ghg:CrackingCokingReformingUnitDetails>
</ghg:CrackingCokingReformingDetails>

```

```

</ghg:UnitIdentification>
<ghg:MaximumRatedThroughputofUnit rateUOM="bbls/streamday">
  <ghg:MeasureValue>12</ghg:MeasureValue>
</ghg:MaximumRatedThroughputofUnit>
<ghg:CrackingCokingEmissionsDetails>
  <ghg:CH4Emissions massUOM="Metric Tons">
    <ghg:CalculatedValue>12312.33</ghg:CalculatedValue>
  </ghg:CH4Emissions>
  <ghg:CH4EmissionsCalculationMethod>Equation Y-9 with a default emission factor</ghg:CH4EmissionsCalculationMethod>
  <ghg:N2OEmissions massUOM="Metric Tons">
    <ghg:CalculatedValue>122121.235</ghg:CalculatedValue>
  </ghg:N2OEmissions>
  <ghg:N2OEmissionsCalculationMethod>Equation Y-10 with a default emission factor</ghg:N2OEmissionsCalculationMethod>
</ghg:CrackingCokingEmissionsDetails>
</ghg:CrackingCokingReformingUnitDetails>
<ghg:CrackingCokingReformingUnitDetails>
  <ghg:UnitIdentification>
    <ghg:UnitName>FCCU-Y6Y7b-001</ghg:UnitName>
    <ghg:UnitType>Fluid Catalytic Cracking Unit</ghg:UnitType>
  </ghg:UnitIdentification>
  <ghg:MaximumRatedThroughputofUnit rateUOM="bbls/streamday">
    <ghg:MeasureValue>655</ghg:MeasureValue>
  </ghg:MaximumRatedThroughputofUnit>
  <ghg:CrackingCokingEmissionsDetails>
    <ghg:CO2Emissions massUOM="Metric Tons">
      <ghg:CalculatedValue>6544.2</ghg:CalculatedValue>
    </ghg:CO2Emissions>
    <ghg:CO2EmissionsCalculationMethod>Equation Y-6 and Y-7b - 98.253(c)(2)</ghg:CO2EmissionsCalculationMethod>
    <ghg:CH4Emissions massUOM="Metric Tons">
      <ghg:CalculatedValue>4456.12</ghg:CalculatedValue>
    </ghg:CH4Emissions>
    <ghg:CH4EmissionsCalculationMethod>Equation Y-9 with a default emission factor</ghg:CH4EmissionsCalculationMethod>
    <ghg:N2OEmissions massUOM="Metric Tons">
      <ghg:CalculatedValue>896.232</ghg:CalculatedValue>
    </ghg:N2OEmissions>
    <ghg:N2OEmissionsCalculationMethod>Equation Y-10 with a default emission factor</ghg:N2OEmissionsCalculationMethod>
  </ghg:CrackingCokingEmissionsDetails>
  <ghg:Y6Details>
    <ghg:AnnualAverageExhaustGasFlowRate rateUOM="dscf/hour">
      <ghg:MeasureValue>345</ghg:MeasureValue>
    </ghg:AnnualAverageExhaustGasFlowRate>
    <ghg:PercentCO2 percentUOM="Number (between 0 and 100)">
      <ghg:MeasureValue>25</ghg:MeasureValue>
      <ghg:NumberOfTimesSubstituted>98</ghg:NumberOfTimesSubstituted>
    </ghg:PercentCO2>
    <ghg:PercentCO2ManufacturersHoursDetails>
      <ghg:ManufacturersMethod>Test Method 1</ghg:ManufacturersMethod>
    </ghg:PercentCO2ManufacturersHoursDetails>
    <ghg:PercentCO percentUOM="Number (between 0 and 100)">
      <ghg:MeasureValue>3</ghg:MeasureValue>
      <ghg:NumberOfTimesSubstituted>200</ghg:NumberOfTimesSubstituted>
    </ghg:PercentCO>
    <ghg:PercentCOManufacturersHoursDetails>
      <ghg:ManufacturersMethod>Test Method 2</ghg:ManufacturersMethod>
    </ghg:PercentCOManufacturersHoursDetails>
  </ghg:Y6Details>
  <ghg:Y7bDetails>
    <ghg:AnnualAverageInletGasFlowRate rateUOM="dscf/hour">
      <ghg:MeasureValue>564.232</ghg:MeasureValue>
    </ghg:AnnualAverageInletGasFlowRate>
  </ghg:Y7bDetails>

```

```

    <ghg:OxygenEnrichedAir rateUOM="dscf/hour">
      <ghg:MeasureValue>345.2322</ghg:MeasureValue>
    </ghg:OxygenEnrichedAir>
    <ghg:PercentN2ExhaustGas percentUOM="Number (between 0 and 100)">
      <ghg:MeasureValue>45</ghg:MeasureValue>
      <ghg:NumberOfTimesSubstituted>3</ghg:NumberOfTimesSubstituted>
    </ghg:PercentN2ExhaustGas>
    <ghg:PercentN2ExhaustGasManufacturersMethodDetails>
      <ghg:ManufacturersMethod>Method 18 at 40 CFR part 60, appendix A-6</ghg:ManufacturersMethod>
    </ghg:PercentN2ExhaustGasManufacturersMethodDetails>
    <ghg:PercentN2Inlet percentUOM="Number (between 0 and 100)">
      <ghg:MeasureValue>3</ghg:MeasureValue>
      <ghg:NumberOfTimesSubstituted>70</ghg:NumberOfTimesSubstituted>
    </ghg:PercentN2Inlet>
    <ghg:PercentN2InletManufacturersMethodDetails>
      <ghg:ManufacturersMethod>UOP539-97</ghg:ManufacturersMethod>
    </ghg:PercentN2InletManufacturersMethodDetails>
  </ghg:Y7bDetails>
</ghg:Y6Details>
</ghg:CrackingCokingReformingUnitDetails>
<ghg:CrackingCokingReformingUnitDetails>
  <ghg:UnitIdentification>
    <ghg:UnitName>FCCU-Y6CM-001</ghg:UnitName>
    <ghg:UnitDescription>test unit</ghg:UnitDescription>
    <ghg:UnitType>Fluid Catalytic Cracking Unit</ghg:UnitType>
  </ghg:UnitIdentification>
  <ghg:MaximumRatedThroughputofUnit rateUOM="bbbls/streamday">
    <ghg:MeasureValue>123</ghg:MeasureValue>
  </ghg:MaximumRatedThroughputofUnit>
  <ghg:CrackingCokingEmissionsDetails>
    <ghg:CO2Emissions massUOM="Metric Tons">
      <ghg:CalculatedValue>1111.1</ghg:CalculatedValue>
    </ghg:CO2Emissions>
    <ghg:CO2EmissionsCalculationMethod>Equation Y-6 and continuous monitor for flow - 98.253(c)(2)</ghg:CO2EmissionsCalculationMethod>
    <ghg:CH4Emissions massUOM="Metric Tons">
      <ghg:CalculatedValue>1540.46</ghg:CalculatedValue>
    </ghg:CH4Emissions>
    <ghg:CH4EmissionsCalculationMethod>Equation Y-9 with a default emission factor</ghg:CH4EmissionsCalculationMethod>
    <ghg:N2OEmissions massUOM="Metric Tons">
      <ghg:CalculatedValue>2222.875</ghg:CalculatedValue>
    </ghg:N2OEmissions>
    <ghg:N2OEmissionsCalculationMethod>Equation Y-10 with a default emission factor</ghg:N2OEmissionsCalculationMethod>
  </ghg:CrackingCokingEmissionsDetails>
</ghg:Y6Details>
<ghg:Y6Details>
  <ghg:AnnualAverageExhaustGasFlowRate rateUOM="dscf/hour">
    <ghg:MeasureValue>232.34333</ghg:MeasureValue>
    <ghg:NumberOfTimesSubstituted>65</ghg:NumberOfTimesSubstituted>
  </ghg:AnnualAverageExhaustGasFlowRate>
  <ghg:ExhaustGasFlowRateManufacturersHoursDetails>
    <ghg:ManufacturersMethod>Test method 1</ghg:ManufacturersMethod>
  </ghg:ExhaustGasFlowRateManufacturersHoursDetails>
  <ghg:PercentCO2 percentUOM="Number (between 0 and 100)">
    <ghg:MeasureValue>50</ghg:MeasureValue>
    <ghg:NumberOfTimesSubstituted>67</ghg:NumberOfTimesSubstituted>
  </ghg:PercentCO2>
  <ghg:PercentCO2ManufacturersHoursDetails>
    <ghg:ManufacturersMethod>Test method 2</ghg:ManufacturersMethod>
  </ghg:PercentCO2ManufacturersHoursDetails>
  <ghg:PercentCO percentUOM="Number (between 0 and 100)">

```

```

    <ghg:MeasureValue>0.54</ghg:MeasureValue>
    <ghg:NumberOfTimesSubstituted>2</ghg:NumberOfTimesSubstituted>
  </ghg:PercentCO>
  <ghg:PercentCOManufacturersHoursDetails>
    <ghg:ManufacturersMethod>Test method 3</ghg:ManufacturersMethod>
  </ghg:PercentCOManufacturersHoursDetails>
</ghg:Y6Details>
</ghg:CrackingCokingReformingUnitDetails>
<ghg:CrackingCokingReformingUnitDetails>
  <ghg:UnitIdentification>
    <ghg:UnitName>FCCU-Y6Y7a-001</ghg:UnitName>
    <ghg:UnitType>Fluid Catalytic Cracking Unit</ghg:UnitType>
  </ghg:UnitIdentification>
  <ghg:MaximumRatedThroughputofUnit rateUOM="bbls/streamday">
    <ghg:MeasureValue>1111</ghg:MeasureValue>
  </ghg:MaximumRatedThroughputofUnit>
  <ghg:CrackingCokingEmissionsDetails>
    <ghg:CO2Emissions massUOM="Metric Tons">
      <ghg:CalculatedValue>6543.2</ghg:CalculatedValue>
    </ghg:CO2Emissions>
    <ghg:CO2EmissionsCalculationMethod>Equation Y-6 and Y-7a - 98.253(c)(2)</ghg:CO2EmissionsCalculationMethod>
    <ghg:CH4Emissions massUOM="Metric Tons">
      <ghg:CalculatedValue>4542.67</ghg:CalculatedValue>
    </ghg:CH4Emissions>
    <ghg:CH4EmissionsCalculationMethod>Equation Y-9 with a default emission factor</ghg:CH4EmissionsCalculationMethod>
    <ghg:N2OEmissions massUOM="Metric Tons">
      <ghg:CalculatedValue>765.977</ghg:CalculatedValue>
    </ghg:N2OEmissions>
    <ghg:N2OEmissionsCalculationMethod>Equation Y-10 with a default emission factor</ghg:N2OEmissionsCalculationMethod>
  </ghg:CrackingCokingEmissionsDetails>
</ghg:Y6Details>
  <ghg:AnnualAverageExhaustGasFlowRate rateUOM="dscf/hour">
    <ghg:MeasureValue>344.09808</ghg:MeasureValue>
  </ghg:AnnualAverageExhaustGasFlowRate>
  <ghg:PercentCO2 percentUOM="Number (between 0 and 100)">
    <ghg:MeasureValue>34</ghg:MeasureValue>
    <ghg:NumberOfTimesSubstituted>16</ghg:NumberOfTimesSubstituted>
  </ghg:PercentCO2>
  <ghg:PercentCO2ManufacturersHoursDetails>
    <ghg:ManufacturersMethod>Test Method 1</ghg:ManufacturersMethod>
  </ghg:PercentCO2ManufacturersHoursDetails>
  <ghg:PercentCO percentUOM="Number (between 0 and 100)">
    <ghg:MeasureValue>60</ghg:MeasureValue>
    <ghg:NumberOfTimesSubstituted>23</ghg:NumberOfTimesSubstituted>
  </ghg:PercentCO>
  <ghg:PercentCOManufacturersHoursDetails>
    <ghg:ManufacturersMethod>Test Method 1</ghg:ManufacturersMethod>
  </ghg:PercentCOManufacturersHoursDetails>
</ghg:Y7aDetails>
  <ghg:AnnualAverageInletGasFlowRate rateUOM="dscf/hour">
    <ghg:MeasureValue>45</ghg:MeasureValue>
  </ghg:AnnualAverageInletGasFlowRate>
  <ghg:OxygenEnrichedAir rateUOM="dscf/hour">
    <ghg:MeasureValue>35</ghg:MeasureValue>
  </ghg:OxygenEnrichedAir>
  <ghg:PercentO2ExhaustGas percentUOM="Number (between 0 and 100)">
    <ghg:MeasureValue>75</ghg:MeasureValue>
    <ghg:NumberOfTimesSubstituted>0</ghg:NumberOfTimesSubstituted>
  </ghg:PercentO2ExhaustGas>

```

```

    <ghg:PercentO2ExhaustGasManufacturersMethodDetails>
      <ghg:ManufacturersMethod>Test Method 3</ghg:ManufacturersMethod>
    </ghg:PercentO2ExhaustGasManufacturersMethodDetails>
    <ghg:PercentO2Inlet percentUOM="Number (between 0 and 100)">
      <ghg:MeasureValue>66</ghg:MeasureValue>
    </ghg:PercentO2Inlet>
  </ghg:Y7aDetails>
</ghg:Y6Details>
</ghg:CrackingCokingReformingUnitDetails>
<ghg:CrackingCokingReformingUnitDetails>
  <ghg:UnitIdentification>
    <ghg:UnitName>CCU-Y11-001</ghg:UnitName>
    <ghg:UnitType>Catalytic Reforming Unit</ghg:UnitType>
  </ghg:UnitIdentification>
  <ghg:MaximumRatedThroughputofUnit rateUOM="bbls/streamday">
    <ghg:MeasureValue>80</ghg:MeasureValue>
  </ghg:MaximumRatedThroughputofUnit>
  <ghg:CrackingCokingEmissionsDetails>
    <ghg:CO2Emissions massUOM="Metric Tons">
      <ghg:CalculatedValue>5678.6</ghg:CalculatedValue>
    </ghg:CO2Emissions>
    <ghg:CO2EmissionsCalculationMethod>Equation Y-11 - 98.253(e)(3)</ghg:CO2EmissionsCalculationMethod>
    <ghg:CH4Emissions massUOM="Metric Tons">
      <ghg:CalculatedValue>2345.88</ghg:CalculatedValue>
    </ghg:CH4Emissions>
    <ghg:CH4EmissionsCalculationMethod>Equation Y-9 with a default emission factor</ghg:CH4EmissionsCalculationMethod>
    <ghg:N2OEmissions massUOM="Metric Tons">
      <ghg:CalculatedValue>2322.999</ghg:CalculatedValue>
    </ghg:N2OEmissions>
    <ghg:N2OEmissionsCalculationMethod>Equation Y-10 with a default emission factor</ghg:N2OEmissionsCalculationMethod>
  </ghg:CrackingCokingEmissionsDetails>
  <ghg:Y11Details>
    <ghg:NumberRegenerationCycles>23</ghg:NumberRegenerationCycles>
    <ghg:AverageCokeBurnOffPerCycle rateUOM="kg/cycle or kg/measurement period">
      <ghg:MeasureValue>345</ghg:MeasureValue>
    </ghg:AverageCokeBurnOffPerCycle>
  </ghg:Y11Details>
</ghg:CrackingCokingReformingUnitDetails>
<ghg:CrackingCokingReformingUnitDetails>
  <ghg:UnitIdentification>
    <ghg:UnitName>FCCU-Y8-001</ghg:UnitName>
    <ghg:UnitType>Fluid Catalytic Cracking Unit</ghg:UnitType>
  </ghg:UnitIdentification>
  <ghg:MaximumRatedThroughputofUnit rateUOM="bbls/streamday">
    <ghg:MeasureValue>100</ghg:MeasureValue>
  </ghg:MaximumRatedThroughputofUnit>
  <ghg:CrackingCokingEmissionsDetails>
    <ghg:CO2Emissions massUOM="Metric Tons">
      <ghg:CalculatedValue>6211.3</ghg:CalculatedValue>
    </ghg:CO2Emissions>
    <ghg:CO2EmissionsCalculationMethod>Equation Y-8 - 98.253(c)(3)</ghg:CO2EmissionsCalculationMethod>
    <ghg:CH4Emissions massUOM="Metric Tons">
      <ghg:CalculatedValue>2348.22</ghg:CalculatedValue>
    </ghg:CH4Emissions>
    <ghg:CH4EmissionsCalculationMethod>Equation Y-9 with a default emission factor</ghg:CH4EmissionsCalculationMethod>
    <ghg:N2OEmissions massUOM="Metric Tons">
      <ghg:CalculatedValue>346.111</ghg:CalculatedValue>
    </ghg:N2OEmissions>
    <ghg:N2OEmissionsCalculationMethod>Equation Y-10 with a default emission factor</ghg:N2OEmissionsCalculationMethod>
  </ghg:CrackingCokingEmissionsDetails>

```

```

    </ghg:CrackingCokingEmissionsDetails>
    <ghg:Y8Details>
      <ghg:CarbonContentBasis>Weekly or more frequent measurements</ghg:CarbonContentBasis>
    </ghg:Y8Details>
  </ghg:CrackingCokingReformingUnitDetails>
  <ghg:CrackingCokingCEMSDetails>
    <ghg:UnitIdentification>
      <ghg:UnitName>CC-CEMS-001</ghg:UnitName>
      <ghg:UnitType>Fluid Catalytic Cracking Unit</ghg:UnitType>
    </ghg:UnitIdentification>
  </ghg:CrackingCokingCEMSDetails>
</ghg:CrackingCokingReformingDetails>
<ghg:SulfurRecoveryDetails>
  <ghg:SourGasDetails>
    <ghg:isSourGasStreamSentOffSiteIndicator>Y</ghg:isSourGasStreamSentOffSiteIndicator>
    <ghg:CalculatedCO2Emissions massUOM="Metric Tons">
      <ghg:CalculatedValue>7687.1</ghg:CalculatedValue>
    </ghg:CalculatedCO2Emissions>
    <ghg:AnnualVolumetricFlow>
      <ghg:NumberOfTimesSubstituted>80</ghg:NumberOfTimesSubstituted>
    </ghg:AnnualVolumetricFlow>
    <ghg:AnnualVolumetricFlowMethod>ASTM - method 1</ghg:AnnualVolumetricFlowMethod>
    <ghg:AverageMoleFractionofCarboninSourGas>
      <ghg:NumberOfTimesSubstituted>2</ghg:NumberOfTimesSubstituted>
    </ghg:AverageMoleFractionofCarboninSourGas>
    <ghg:AverageMoleFractionofCarboninSourGasMethod>ASTM D1945-03</ghg:AverageMoleFractionofCarboninSourGasMethod>
  </ghg:SourGasDetails>
  <ghg:SulfurRecoveryUnitDetails>
    <ghg:UnitIdentification>
      <ghg:UnitName>SR-002</ghg:UnitName>
      <ghg:UnitType>Sulfur Recovery Plant</ghg:UnitType>
    </ghg:UnitIdentification>
    <ghg:SulfurRecoveryPlantDescription>Caustic scrubber</ghg:SulfurRecoveryPlantDescription>
    <ghg:MaxRatedThroughputofUnit rateUOM="metric tons/streamday">
      <ghg:MeasureValue>231</ghg:MeasureValue>
    </ghg:MaxRatedThroughputofUnit>
    <ghg:CalculatedCO2Emissions massUOM="Metric Tons">
      <ghg:CalculatedValue>4544.5</ghg:CalculatedValue>
    </ghg:CalculatedCO2Emissions>
    <ghg:CO2EmissionMethod>Equation Y-12</ghg:CO2EmissionMethod>
    <ghg:isRecycledTailgasIncludedIndicator>Y</ghg:isRecycledTailgasIncludedIndicator>
    <ghg:AnnualVolumetricFlow>
      <ghg:NumberOfTimesSubstituted>126</ghg:NumberOfTimesSubstituted>
    </ghg:AnnualVolumetricFlow>
    <ghg:AnnualVolumetricFlowMethod>test</ghg:AnnualVolumetricFlowMethod>
    <ghg:AverageMoleFractionofCarboninSourGas>
      <ghg:NumberOfTimesSubstituted>123</ghg:NumberOfTimesSubstituted>
    </ghg:AverageMoleFractionofCarboninSourGas>
    <ghg:AverageMoleFractionofCarboninSourGasMethod>Method 18 at 40 CFR part 60, appendix A-6</ghg:AverageMoleFractionofCarboninSourGasMethod>
  <ghg:RecycleTailGasDetails>
    <ghg:TailGasRecycledFlowRateCarbonContentIncluded>Y</ghg:TailGasRecycledFlowRateCarbonContentIncluded>
    <ghg:TailGasCorrectionforCO2Used>Y</ghg:TailGasCorrectionforCO2Used>
    <ghg:RecycleTailGasVolume>
      <ghg:NumberOfTimesSubstituted>132</ghg:NumberOfTimesSubstituted>
    </ghg:RecycleTailGasVolume>
    <ghg:RecycledTailGasMethodDetails>
      <ghg:RecycledTailGasMethod>Engineering estimates</ghg:RecycledTailGasMethod>
    </ghg:RecycledTailGasMethodDetails>
    <ghg:AnnualAverageMoleFractionofCarbon fractionUOM="kg-mole C/kg-molegas">

```

```

        <ghg:NumberofTimesSubstituted>123</ghg:NumberofTimesSubstituted>
    </ghg:AnnualAverageMoleFractionofCarbon>
    <ghg:AnnualAverageMoleFractionofCarbonMethod>Engineering calculations</ghg:AnnualAverageMoleFractionofCarbonMethod>
    <ghg:BasisforCorrection>Unit-specific correction factor</ghg:BasisforCorrection>
    <ghg:ApproachUsedforCorrection>Used measurement data for the annual volume of recycled tail gas and annual average mole fraction of carbon in the tail
gas</ghg:ApproachUsedforCorrection>
    </ghg:RecycleTailGasDetails>
</ghg:SulfurRecoveryUnitDetails>
<ghg:SulfurRecoveryUnitDetails>
    <ghg:UnitIdentification>
        <ghg:UnitName>SR-001</ghg:UnitName>
        <ghg:UnitType>Sulfur Recovery Plant</ghg:UnitType>
    </ghg:UnitIdentification>
    <ghg:SulfurRecoveryPlantDescription>Caustic scrubber</ghg:SulfurRecoveryPlantDescription>
    <ghg:MaxRatedThroughputofUnit rateUOM="metric tons/streamday">
        <ghg:MeasureValue>375</ghg:MeasureValue>
    </ghg:MaxRatedThroughputofUnit>
    <ghg:CalculatedCO2Emissions massUOM="Metric Tons">
        <ghg:CalculatedValue>623.4</ghg:CalculatedValue>
    </ghg:CalculatedCO2Emissions>
    <ghg:CO2EmissionMethod>Process Vent Method</ghg:CO2EmissionMethod>
    <ghg:ProcessVentMethodDetails>
        <ghg:CumulativeAnnualVolumeFlowDischarged volUOM="scf">
            <ghg:MeasureValue>123.9</ghg:MeasureValue>
        </ghg:CumulativeAnnualVolumeFlowDischarged>
        <ghg:CumulativeAnnualVolumeFlowDischargedMethod>Process knowledge</ghg:CumulativeAnnualVolumeFlowDischargedMethod>
        <ghg:CumulativeNumberVentingEvents>
            <ghg:MeasureValue>25</ghg:MeasureValue>
        </ghg:CumulativeNumberVentingEvents>
        <ghg:CumulativeVentingTime>187</ghg:CumulativeVentingTime>
    </ghg:MoleFractionDetails>
        <ghg:CO2AnnualAverageMoleFraction fractionUOM="fraction (number between 0 and 1)">
            <ghg:MeasureValue>0.5</ghg:MeasureValue>
        </ghg:CO2AnnualAverageMoleFraction>
        <ghg:CO2AnnualAverageMoleFractionMethod>Direct measurement</ghg:CO2AnnualAverageMoleFractionMethod>
</ghg:MoleFractionDetails>
    </ghg:ProcessVentMethodDetails>
</ghg:SulfurRecoveryUnitDetails>
</ghg:SulfurRecoveryDetails>
<ghg:CokeCalciningDetails>
    <ghg:CokeCalciningUnitDetails>
        <ghg:UnitIdentification>
            <ghg:UnitName>CC-001</ghg:UnitName>
            <ghg:UnitType>Coke Calcining Unit</ghg:UnitType>
        </ghg:UnitIdentification>
        <ghg:MaxRatedThroughputofUnit rateUOM="metric tons/streamday">
            <ghg:MeasureValue>232</ghg:MeasureValue>
        </ghg:MaxRatedThroughputofUnit>
        <ghg:CokeCalciningEmissionsDetails>
            <ghg:CO2Emissions massUOM="Metric Tons">
                <ghg:CalculatedValue>121.7</ghg:CalculatedValue>
            </ghg:CO2Emissions>
            <ghg:CO2EmissionsCalculationMethod>Equation Y-13</ghg:CO2EmissionsCalculationMethod>
            <ghg:CH4Emissions massUOM="Metric Tons">
                <ghg:CalculatedValue>222.67</ghg:CalculatedValue>
            </ghg:CH4Emissions>
            <ghg:CH4EmissionsCalculationMethod>Unit-specific emission factor based on a source test of the unit</ghg:CH4EmissionsCalculationMethod>
            <ghg:CH4UnitSpecificFactorBasis>Periodic (less frequent than weekly) measurements</ghg:CH4UnitSpecificFactorBasis>
            <ghg:N2OEmissions massUOM="Metric Tons">
                <ghg:CalculatedValue>8675.757</ghg:CalculatedValue>
            </ghg:N2OEmissions>
        </ghg:CokeCalciningEmissionsDetails>
    </ghg:CokeCalciningUnitDetails>
</ghg:CokeCalciningDetails>
</ghg:ApproachUsedforCorrection>
</ghg:RecycleTailGasDetails>
</ghg:AnnualAverageMoleFractionofCarbon>
</ghg:AnnualAverageMoleFractionofCarbonMethod>
</ghg:BasisforCorrection>
</ghg:ApproachUsedforCorrection>

```



```

    </ghg:N2OEmissions>
    <ghg:N2OEmissionsCalculationMethod>Equation Y-10 with a default emission factor</ghg:N2OEmissionsCalculationMethod>
  </ghg:CokeCalciningEmissionsDetails>
  <ghg:CarbonContentofGreenCokeFedMethod>ASTM D5373-08</ghg:CarbonContentofGreenCokeFedMethod>
  <ghg:CarbonContentofMarketableCokeMethod>ASTM D3176-89 (Reapproved 2002)</ghg:CarbonContentofMarketableCokeMethod>
  <ghg:CokeDustRecyclingDescription>All dust is recycled</ghg:CokeDustRecyclingDescription>
</ghg:CokeCalciningUnitDetails>
<ghg:CokeCalciningUnitDetails>
  <ghg:UnitIdentification>
    <ghg:UnitName>CCU-CEMS-001</ghg:UnitName>
    <ghg:UnitType>Coke Calcining Unit</ghg:UnitType>
  </ghg:UnitIdentification>
  <ghg:MaxRatedThroughputofUnit rateUOM="metric tons/streamday">
    <ghg:MeasureValue>33433</ghg:MeasureValue>
  </ghg:MaxRatedThroughputofUnit>
  <ghg:CokeCalciningEmissionsDetails>
    <ghg:CH4Emissions massUOM="Metric Tons">
      <ghg:CalculatedValue>23233.44</ghg:CalculatedValue>
    </ghg:CH4Emissions>
    <ghg:CH4EmissionsCalculationMethod>Unit-specific emission factor based on a source test of the unit</ghg:CH4EmissionsCalculationMethod>
    <ghg:CH4UnitSpecificFactorBasis>Periodic (less frequent than weekly) measurements</ghg:CH4UnitSpecificFactorBasis>
    <ghg:N2OEmissions massUOM="Metric Tons">
      <ghg:CalculatedValue>2223.333</ghg:CalculatedValue>
    </ghg:N2OEmissions>
    <ghg:N2OEmissionsCalculationMethod>Unit-specific emission factor based on a source test of the unit</ghg:N2OEmissionsCalculationMethod>
    <ghg:N2OUnitSpecificFactorBasis>One-time source test</ghg:N2OUnitSpecificFactorBasis>
  </ghg:CokeCalciningEmissionsDetails>
</ghg:CokeCalciningUnitDetails>
<ghg:CokeCalciningCEMSDetails>
  <ghg:UnitIdentification>
    <ghg:UnitName>CCU-CEMS-001</ghg:UnitName>
    <ghg:UnitType>Coke Calcining Unit</ghg:UnitType>
  </ghg:UnitIdentification>
</ghg:CokeCalciningCEMSDetails>
</ghg:CokeCalciningDetails>
<ghg:AsphaltBlowingDetails>
  <ghg:AsphaltBlowingUnitDetails>
    <ghg:UnitIdentification>
      <ghg:UnitName>AB-001</ghg:UnitName>
      <ghg:UnitDescription>description text</ghg:UnitDescription>
      <ghg:UnitType>Asphalt Blowing Unit</ghg:UnitType>
    </ghg:UnitIdentification>
    <ghg:ControlDeviceTypetoReduceEmissions>Vapor scrubber</ghg:ControlDeviceTypetoReduceEmissions>
    <ghg:CO2EmissionsMethod>Equation Y-14 and Y-15</ghg:CO2EmissionsMethod>
    <ghg:CO2Emissions massUOM="Metric Tons">
      <ghg:CalculatedValue>23411.9</ghg:CalculatedValue>
    </ghg:CO2Emissions>
    <ghg:CH4Emissions massUOM="Metric Tons">
      <ghg:CalculatedValue>2224.57</ghg:CalculatedValue>
    </ghg:CH4Emissions>
    <ghg:Y14Y15Details>
      <ghg:BasisforCO2EmissionsFactor>Average of multiple source tests</ghg:BasisforCO2EmissionsFactor>
      <ghg:BasisforCH4EmissionsFactor>Average of multiple source tests</ghg:BasisforCH4EmissionsFactor>
    </ghg:Y14Y15Details>
  </ghg:AsphaltBlowingUnitDetails>
</ghg:AsphaltBlowingDetails>
<ghg:DelayedCokingDetails>
  <ghg:TotalDelayCokingUnits>2</ghg:TotalDelayCokingUnits>
  <ghg:TotalDrums>1</ghg:TotalDrums>

```

```

<ghg:TotalCH4Emissions massUOM="Metric Tons">
  <ghg:MeasureValue>4555.33</ghg:MeasureValue>
</ghg:TotalCH4Emissions>
<ghg:DelayedCokingUnitDetails>
  <ghg:UnitIdentification>
    <ghg:UnitName>DC-001</ghg:UnitName>
    <ghg:UnitDescription>This is a test unit</ghg:UnitDescription>
    <ghg:UnitType>Delayed Coking Unit</ghg:UnitType>
  </ghg:UnitIdentification>
  <ghg:MethodtoCalculateCH4Emissions>Equation Y-18 and Y-19 - 98.253(i)(1)</ghg:MethodtoCalculateCH4Emissions>
  <ghg:DrumsDetails>
    <ghg:DrumIdentifier>DRUM-001</ghg:DrumIdentifier>
    <ghg:DrumOutage heightUOM="Feet">
      <ghg:MeasureValue>35</ghg:MeasureValue>
    </ghg:DrumOutage>
  </ghg:DrumsDetails>
</ghg:DelayedCokingUnitDetails>
<ghg:DelayedCokingUnitDetails>
  <ghg:UnitIdentification>
    <ghg:UnitName>DC-002</ghg:UnitName>
    <ghg:UnitDescription>This is a test unit</ghg:UnitDescription>
    <ghg:UnitType>Delayed Coking Unit</ghg:UnitType>
  </ghg:UnitIdentification>
  <ghg:MethodtoCalculateCH4Emissions>Equation Y-18 - 98.253(i)(2)</ghg:MethodtoCalculateCH4Emissions>
  <ghg:DrumsDetails>
    <ghg:DrumIdentifier>D-1</ghg:DrumIdentifier>
    <ghg:DrumOutage heightUOM="Feet">
      <ghg:MeasureValue>5</ghg:MeasureValue>
    </ghg:DrumOutage>
  </ghg:DrumsDetails>
  <ghg:DrumsDetails>
    <ghg:DrumIdentifier>D-2</ghg:DrumIdentifier>
    <ghg:DrumOutage heightUOM="Feet">
      <ghg:MeasureValue>7</ghg:MeasureValue>
    </ghg:DrumOutage>
  </ghg:DrumsDetails>
  <ghg:DrumsDetails>
    <ghg:DrumIdentifier>D-3</ghg:DrumIdentifier>
    <ghg:DrumOutage heightUOM="Feet">
      <ghg:MeasureValue>9</ghg:MeasureValue>
    </ghg:DrumOutage>
  </ghg:DrumsDetails>
</ghg:DelayedCokingUnitDetails>
<ghg:DrumsSetDetails>
  <ghg:NumberOfCokingDrums>6</ghg:NumberOfCokingDrums>
  <ghg:BasisforVolumetricVoidFraction>Measurement data</ghg:BasisforVolumetricVoidFraction>
  <ghg:BasisforMoleFraction>Weekly or more frequent measurements</ghg:BasisforMoleFraction>
</ghg:DrumsSetDetails>
</ghg:DelayedCokingUnitDetails>
<ghg:ProcessVentsDetails>
  <ghg:ProcessVentsUnitDetails>
    <ghg:UnitIdentification>
      <ghg:UnitName>PV-001</ghg:UnitName>
      <ghg:UnitType>Process Vent</ghg:UnitType>
    </ghg:UnitIdentification>
    <ghg:OperationType>Petroleum coke storage</ghg:OperationType>
    <ghg:ControlDeviceTypetoReduceEmissions>Thermal or catalytic incinerator/oxidizer</ghg:ControlDeviceTypetoReduceEmissions>
    <ghg:CO2Emissions massUOM="Metric Tons">
      <ghg:CalculatedValue>3242.7</ghg:CalculatedValue>
    </ghg:CO2Emissions>
  </ghg:ProcessVentsUnitDetails>
</ghg:ProcessVentsDetails>

```

```

</ghg:CO2Emissions>
<ghg:CH4Emissions massUOM="Metric Tons">
  <ghg:CalculatedValue>1004.34</ghg:CalculatedValue>
</ghg:CH4Emissions>
<ghg:N2OEmissions massUOM="Metric Tons">
  <ghg:CalculatedValue>235.112</ghg:CalculatedValue>
</ghg:N2OEmissions>
<ghg:AnnualVolumetricFlowDischarged rateUOM="scf">
  <ghg:MeasureValue>3444.345111</ghg:MeasureValue>
</ghg:AnnualVolumetricFlowDischarged>
<ghg:AnnualVolumeMetricFlowMethod>Continuous or at least hourly measurements</ghg:AnnualVolumeMetricFlowMethod>
<ghg:InterVentsDetails>
  <ghg:NumberofVentingEvents>3</ghg:NumberofVentingEvents>
  <ghg:TotalVentingTime timeUOM="Hours">40</ghg:TotalVentingTime>
</ghg:InterVentsDetails>
<ghg:MoleFractionDetails>
  <ghg:CO2AnnualAverageMoleFraction fractionUOM="fraction (number between 0 and 1)">
    <ghg:MeasureValue>0.5</ghg:MeasureValue>
  </ghg:CO2AnnualAverageMoleFraction>
  <ghg:CO2AnnualAverageMoleFractionMethod>Direct measurement</ghg:CO2AnnualAverageMoleFractionMethod>
  <ghg:CH4AnnualAverageMoleFraction fractionUOM="fraction (number between 0 and 1)">
    <ghg:MeasureValue>0.33</ghg:MeasureValue>
  </ghg:CH4AnnualAverageMoleFraction>
  <ghg:CH4AnnualAverageMoleFractionMethod>Engineering estimates/process knowledge</ghg:CH4AnnualAverageMoleFractionMethod>
  <ghg:N2OAnnualAverageMoleFraction fractionUOM="fraction (number between 0 and 1)">
    <ghg:MeasureValue>0.75</ghg:MeasureValue>
  </ghg:N2OAnnualAverageMoleFraction>
  <ghg:N2OAnnualAverageMoleFractionMethod>Other (specify)</ghg:N2OAnnualAverageMoleFractionMethod>
  <ghg:OtherN2OAnnualAverageMoleFractionMethod>test method 2</ghg:OtherN2OAnnualAverageMoleFractionMethod>
</ghg:MoleFractionDetails>
</ghg:ProcessVentsUnitDetails>
</ghg:ProcessVentsDetails>
<ghg:UnControlledBlowDownDetails>
  <ghg:TotalCH4Emissions massUOM="Metric Tons">
    <ghg:CalculatedValue>111.2</ghg:CalculatedValue>
  </ghg:TotalCH4Emissions>
  <ghg:TotalCH4EmissionsMethod>Reported under 98.256(j)</ghg:TotalCH4EmissionsMethod>
</ghg:ProcessVentMethodDetails>
  <ghg:CumulativeAnnualVolumeFlowDischarged volUOM="scf">
    <ghg:MeasureValue>12.3453</ghg:MeasureValue>
  </ghg:CumulativeAnnualVolumeFlowDischarged>
  <ghg:CumulativeAnnualVolumeFlowDischargedMethod>Routine (less frequent than hourly but at least weekly)
measurements</ghg:CumulativeAnnualVolumeFlowDischargedMethod>
  <ghg:CumulativeNumberVentingEvents>
    <ghg:MeasureValue>23</ghg:MeasureValue>
  </ghg:CumulativeNumberVentingEvents>
  <ghg:CumulativeVentingTime>12</ghg:CumulativeVentingTime>
</ghg:MoleFractionDetails>
  <ghg:CH4AnnualAverageMoleFraction fractionUOM="fraction (number between 0 and 1)">
    <ghg:MeasureValue>0.5</ghg:MeasureValue>
  </ghg:CH4AnnualAverageMoleFraction>
  <ghg:CH4AnnualAverageMoleFractionMethod>Direct measurement</ghg:CH4AnnualAverageMoleFractionMethod>
</ghg:MoleFractionDetails>
</ghg:ProcessVentMethodDetails>
</ghg:UnControlledBlowDownDetails>
<ghg:EquipmentLeaksDetails>
  <ghg:TotalCH4Emissions massUOM="Metric Tons">
    <ghg:CalculatedValue>2334.88</ghg:CalculatedValue>
  </ghg:TotalCH4Emissions>

```

```

    <ghg:MethodtoCalculateEquipmentLeakEmission>98.253(l)(2) method</ghg:MethodtoCalculateEquipmentLeakEmission>
    <ghg:NCD>32</ghg:NCD>
    <ghg:NPU1>65</ghg:NPU1>
    <ghg:NPU2>87</ghg:NPU2>
    <ghg:NH2>51</ghg:NH2>
    <ghg:NFGS>45</ghg:NFGS>
  </ghg:EquipmentLeaksDetails>
  <ghg:StorageTankDetails>
    <ghg:StabilizedCrudeTotalCH4Emissions massUOM="Metric Tons">
      <ghg:CalculatedValue>2345.77</ghg:CalculatedValue>
    </ghg:StabilizedCrudeTotalCH4Emissions>
    <ghg:StabilizedCrudeCalculationMethod>Equation Y-22</ghg:StabilizedCrudeCalculationMethod>
    <ghg:isStablizedCrudeReceivedStoredIndicator>Y</ghg:isStablizedCrudeReceivedStoredIndicator>
    <ghg:UnStabilizedCrudeTotalCH4Emissions massUOM="Metric Tons">
      <ghg:CalculatedValue>1090.66</ghg:CalculatedValue>
    </ghg:UnStabilizedCrudeTotalCH4Emissions>
    <ghg:UnStabilizedCrudeCalculationMethod>Tank-specific methane composition data and direct measurement of gas generation
rate</ghg:UnStabilizedCrudeCalculationMethod>
    <ghg:isUnStabilizedCrudeReceivedStoredIndicator>Y</ghg:isUnStabilizedCrudeReceivedStoredIndicator>
    <ghg:UnStabilizedCrudeBasisforMoleFraction>Measurement data</ghg:UnStabilizedCrudeBasisforMoleFraction>
    <ghg:UnstabilizedMethaneCompositionMethodDetails>
      <ghg:CH4VaporCompositionData>
        <ghg:NumberOfTimesSubstituted>23</ghg:NumberOfTimesSubstituted>
      </ghg:CH4VaporCompositionData>
      <ghg:CH4VaporCompositionDataMethod>Measurement data</ghg:CH4VaporCompositionDataMethod>
      <ghg:GasGenerationRateData>
        <ghg:NumberOfTimesSubstituted>100</ghg:NumberOfTimesSubstituted>
      </ghg:GasGenerationRateData>
      <ghg:GasGenerationRateDataMethod>Method published by a consensus-based standards organization</ghg:GasGenerationRateDataMethod>
      <ghg:GasGenerationRateDataMethodOther>Method H</ghg:GasGenerationRateDataMethodOther>
    </ghg:UnstabilizedMethaneCompositionMethodDetails>
  </ghg:StorageTankDetails>
  <ghg>LoadingOperationsDetails>
    <ghg>TotalCH4Emissions massUOM="Metric Tons">
      <ghg:CalculatedValue>244.36</ghg:CalculatedValue>
    </ghg>TotalCH4Emissions>
    <ghg:VesselDetails>
      <ghg:VesselType>Railcar</ghg:VesselType>
      <ghg:VesselMaterialDetails>
        <ghg:MaterialType>Oxygenates</ghg:MaterialType>
        <ghg:ControlSystemTypeName>Thermal or catalytic incinerator/oxidizer</ghg:ControlSystemTypeName>
      </ghg:VesselMaterialDetails>
    </ghg:VesselDetails>
  </ghg>LoadingOperationsDetails>
  <ghg:YTier4CEMSDetails>
    <ghg:CEMSMonitoringLocation>
      <ghg:Name>CML-024</ghg:Name>
      <ghg:Type>Multiple processes/process units share common stack</ghg:Type>
    </ghg:CEMSMonitoringLocation>
    <ghg:CO2EmissionsAllBiomassFuelsCombined massUOM="Metric Tons">
      <ghg:CalculatedValue>654.3</ghg:CalculatedValue>
    </ghg:CO2EmissionsAllBiomassFuelsCombined>
    <ghg:CO2EmissionsNonBiogenic massUOM="Metric Tons">
      <ghg:CalculatedValue>50576.1</ghg:CalculatedValue>
    </ghg:CO2EmissionsNonBiogenic>
    <ghg:AnnualCO2EmissionsMeasuredByCEMS massUOM="Metric Tons">
      <ghg:CalculatedValue>51632.9</ghg:CalculatedValue>
    </ghg:AnnualCO2EmissionsMeasuredByCEMS>
    <ghg>TotalCH4CombustionEmissions massUOM="Metric Tons">

```

```

    <ghg:CalculatedValue>65.87</ghg:CalculatedValue>
  </ghg:TotalCH4CombustionEmissions>
  <ghg:TotalN2OCombustionEmissions massUOM="Metric Tons">
    <ghg:CalculatedValue>86.753</ghg:CalculatedValue>
  </ghg:TotalN2OCombustionEmissions>
  <ghg:Tier4QuarterDetails>
    <ghg:QuarterName>First Quarter</ghg:QuarterName>
    <ghg:CumulativeCO2MassEmissions massUOM="Metric Tons">
      <ghg:CalculatedValue>9581.2</ghg:CalculatedValue>
    </ghg:CumulativeCO2MassEmissions>
  </ghg:Tier4QuarterDetails>
  <ghg:Tier4QuarterDetails>
    <ghg:QuarterName>Second Quarter</ghg:QuarterName>
    <ghg:CumulativeCO2MassEmissions massUOM="Metric Tons">
      <ghg:CalculatedValue>4853.5</ghg:CalculatedValue>
    </ghg:CumulativeCO2MassEmissions>
  </ghg:Tier4QuarterDetails>
  <ghg:Tier4QuarterDetails>
    <ghg:QuarterName>Third Quarter</ghg:QuarterName>
    <ghg:CumulativeCO2MassEmissions massUOM="Metric Tons">
      <ghg:CalculatedValue>8465.7</ghg:CalculatedValue>
    </ghg:CumulativeCO2MassEmissions>
  </ghg:Tier4QuarterDetails>
  <ghg:Tier4QuarterDetails>
    <ghg:QuarterName>Fourth Quarter</ghg:QuarterName>
    <ghg:CumulativeCO2MassEmissions massUOM="Metric Tons">
      <ghg:CalculatedValue>8975.3</ghg:CalculatedValue>
    </ghg:CumulativeCO2MassEmissions>
  </ghg:Tier4QuarterDetails>
  <ghg:TotalSourceOperatingHours>85</ghg:TotalSourceOperatingHours>
  <ghg:OperatingHoursDetails>
    <ghg:OperatingHoursCO2ConcentrationSubstituted>74</ghg:OperatingHoursCO2ConcentrationSubstituted>
    <ghg:OperatingHoursStackGasFlowRateSubstituted>96</ghg:OperatingHoursStackGasFlowRateSubstituted>
    <ghg:OperatingHoursStackGasMoistureContentSubstituted>52</ghg:OperatingHoursStackGasMoistureContentSubstituted>
  </ghg:OperatingHoursDetails>
  <ghg:CarbonDioxideCombustionEmissions massUOM="Metric Tons">
    <ghg:MeasureValue>654.3</ghg:MeasureValue>
  </ghg:CarbonDioxideCombustionEmissions>
  <ghg:TierMethodologyStartDate>2011-01-01</ghg:TierMethodologyStartDate>
  <ghg:TierMethodologyEndDate>2011-12-31</ghg:TierMethodologyEndDate>
  <ghg:SlipStreamIndicator>Y</ghg:SlipStreamIndicator>
  <ghg:CEMSFuel>coal, coke, natural gas</ghg:CEMSFuel>
  <ghg:YProcessUnits>
    <ghg:ProcessUnitName>
      <ghg:UnitName>CC-CEMS-001</ghg:UnitName>
    </ghg:ProcessUnitName>
    <ghg:CarbonDioxideProcessEmissions massUOM="Metric Tons">
      <ghg:MeasureValue>412.9</ghg:MeasureValue>
    </ghg:CarbonDioxideProcessEmissions>
  </ghg:YProcessUnits>
  <ghg:YProcessUnits>
    <ghg:ProcessUnitName>
      <ghg:UnitName>CCU-CEMS-001</ghg:UnitName>
    </ghg:ProcessUnitName>
    <ghg:CarbonDioxideProcessEmissions massUOM="Metric Tons">
      <ghg:MeasureValue>258.4</ghg:MeasureValue>
    </ghg:CarbonDioxideProcessEmissions>
  </ghg:YProcessUnits>
</ghg:YTier4CEMSDetails>

```

```
</ghg:SubPartY>  
</ghg:SubPartInformation>  
</ghg:FacilitySiteDetails>  
<ghg:CalculationMethodologyChangesDescription>n/a</ghg:CalculationMethodologyChangesDescription>  
<ghg:BestAvailableMonitoringMethodsUsed>n/a</ghg:BestAvailableMonitoringMethodsUsed>  
<ghg:StartDate>2011-01-01</ghg:StartDate>  
<ghg:EndDate>2011-12-31</ghg:EndDate>  
</ghg:FacilitySiteInformation>  
</ghg:GHG>
```