

# **Greenhouse Gas Reporting Program**

## **XML Reporting Instructions for Subpart PP – Suppliers of Carbon Dioxide**

United States Environmental Protection Agency  
Climate Change Division  
Washington, DC

December 6, 2021

*These instructions explain how to report the required data for the applicable regulations. Owners and operators of units should refer to the applicable regulations for information about what data are required to be reported.*

*[This page intentionally left blank]*

## Table of Contents

	<u>Page</u>
I. Introduction .....	5
II. Summary of Changes .....	12
III. Subpart PP Overview .....	13
1.0 Subpart PP Total GHG Quantity .....	16
2.0 Facility Classification, Calculation Methodology, and Importer/Exporter Classification .....	18
3.0 Meter Details .....	21
4.0 Equation PP-4 CO <sub>2</sub> Details .....	32
5.0 CO <sub>2</sub> End Use Details.....	34
6.0 Equipment Calibration Details.....	37
7.0 Electricity Generating Unit Details.....	39
8.0 Subpart RR Facility Where CO <sub>2</sub> Transferred Details .....	40
9.0 Substitute Data Details .....	42
10.0 Facility/Supplier Level Roll-up GHG Quantity .....	43
IV. Appendix A Sample XML Documents for Subpart PP .....	45
1.0 Capture Facility – Flow Meters 1.....	45
2.0 Capture Facility – Flow Meters 2.....	53
3.0 Capture Facility – Streams with Subpart D and RR Facilities .....	58
4.0 Capture Facility – Flow Meters 1 and Streams .....	63
5.0 Extract Facility – Flow Meters 1.....	69
6.0 Extract Facility – Flow Meters 3.....	74
7.0 Extract Facility – Flow Meter 1 and Streams .....	79
8.0 Extract Facility – Streams.....	85
9.0 Import/Export – Flow Meters 3 .....	90
10.0 Import/Export – Containers.....	98

## List of Tables

	<u>Page</u>
Table 1 Reporting Numbers .....	6
Table 2 Calculated Details Data Element Definitions .....	9
Table 3 Measurement Details Data Element Definitions .....	10
Table 4 Unit Identification Details Data Element Definitions .....	10
Table 5 Greenhouse Gas Information Details Data Element Definitions .....	17
Table 6 Facility Classification Data Element Definitions .....	19
Table 7 Meter Unit Identification and Information Data Element Definitions .....	23
Table 8 Flow Meter Equipment Location Details Data Element Definitions.....	26
Table 9 Mass Details Data Element Definitions.....	27
Table 10 Volume Details Data Element Definitions.....	30
Table 11 Equation PP-4 CO <sub>2</sub> Details Data Element Definitions .....	32
Table 12 CO <sub>2</sub> End Use Details Data Element Definitions .....	35
Table 13 Equipment Calibration Details Data Element Definitions .....	37
Table 14 Electricity Generating Unit Details Element Definitions.....	39
Table 15 Subpart RR Facility Where CO <sub>2</sub> Transferred Details Data Element Definitions.....	41
Table 16 Substitute Data Details Data Element Definitions.....	42
Table 17 Facility Level Roll-up GHG Quantity Data Element Definitions.....	44

## List of Figures

	<u>Page</u>
Figure 1 Example of an XML Tree.....	7
Figure 2 Calculated Details Data Type Schema Diagram.....	9
Figure 3 Measurement Details Data Type Schema Diagram.....	9
Figure 4 Unit Identification Details Data Type Schema Diagram.....	10
Figure 5 “Unbounded” Symbol in Schema Diagram.....	11
Figure 6 Logical “Or” Symbol in Schema Diagram.....	11
Figure 7 Subpart PP Reporting Diagram.....	13
Figure 8 Subpart PP Schema Diagram.....	15
Figure 9 Greenhouse Gas Information Details Schema Diagram.....	16
Figure 10 Facility Classification Schema Diagram.....	19
Figure 11 Meter Details Schema Diagram.....	21
Figure 12 Meter Unit Identification and Information Schema Diagram.....	22
Figure 13 Flow Meter Equipment Location Details Schema Diagram.....	25
Figure 14 Mass Details Schema Diagram.....	27
Figure 15 Volume Details Schema Diagram.....	29
Figure 16 Equation PP-4 CO <sub>2</sub> Details Schema Diagram.....	32
Figure 17 CO <sub>2</sub> End Use Details Schema Diagram.....	34
Figure 18 Equipment Calibration Details Schema Diagram.....	37
Figure 19 Electricity Generating Unit Details Schema Diagram.....	39
Figure 20 Subpart RR Facility Where CO <sub>2</sub> Transferred Details Schema Diagram.....	40
Figure 21 Substitute Data Details Schema Diagram.....	42
Figure 22 Facility/Supplier Level Roll-up GHG Quantity Schema Diagram.....	43

**List of XML Excerpts**

	<b><u>Page</u></b>
XML Excerpt 1	Example for “Unbounded” Parent Element ..... 11
XML Excerpt 2	Example for Greenhouse Gas Information Details ..... 17
XML Excerpt 3	Example for Facility Classification ..... 20
XML Excerpt 4	Example for Meter Unit Identification and Information for Exporter ..... 24
XML Excerpt 5	Example for Flow Meter Equipment Location Details ..... 26
XML Excerpt 6	Example for Mass Details ..... 28
XML Excerpt 7	Example for Volume Details ..... 31
XML Excerpt 8	Example for Equation PP-4 CO <sub>2</sub> Details ..... 33
XML Excerpt 9	Example for CO <sub>2</sub> End Use Details ..... 36
XML Excerpt 10	Example for Equipment Calibration Details ..... 38
XML Excerpt 11	Example for Electricity Generating Unit Details ..... 40
XML Excerpt 12	Example for Subpart RR Facility Where CO <sub>2</sub> Transferred Details ..... 41
XML Excerpt 13	Example for Substitute Data Details ..... 42
XML Excerpt 14	Example for Facility Level Roll-up GHG Quantity ..... 44

## I. Introduction

The U.S. Environmental Protection Agency's (EPA's) electronic greenhouse gas reporting tool (e-GGRT) extensible markup language (XML) Reporting Schema contains all of the data elements needed to comply with the Greenhouse Gas Reporting Program (GHGRP) beginning with the 2010 data collection year. The XML schema defines expected data elements and attributes, allowable data formats for each data element, and the hierarchical structure and sequence in which data elements must appear in the XML file. Similar to an architectural blueprint that describes the structural design of a house, an XML schema describes the structural design of an XML file. In some cases, it also defines which elements are optional and which are required and the maximum number of occurrences allowed for each element.

The e-GGRT XML schema is made up of a root data element (GHG) and complex and simple data elements. A simple element is a single piece of data. A complex element is a group of simple elements which are logically grouped together. The root data element is the base of the XML schema.

The schema's structure can be thought of as a family tree. The elements are related to each other in parent-child relationships. The root element is the parent element of the entire schema. Complex elements are children of the root element, and complex elements can also be children of other complex elements. The XML upload method may be used for reporting a facility or supplier's annual greenhouse gas (GHG) data; however, the following actions can only be performed using the e-GGRT web forms:

- User, facility and supplier registration
- Certificate of Representation and Notice of Delegation signing
- Facility representative and agent changes
- Facility and supplier address changes
- Notice of intent to not submit an annual GHG report

All XML files submitted to e-GGRT must be well formed and will be accepted only if they conform to the current version of the e-GGRT XML schema.

An XML submission must only contain GHG data for a single facility or supplier. All data for a facility or supplier must be submitted in a single file as a complete report and must include all of the relevant Subparts. It is not possible to submit a subset of any portion of a facility's data to add, delete, correct or update. The entire report must be resubmitted to make any modification at all. Each subsequent submission for the same facility replaces all of the previously submitted data.

The e-GGRT XML schema contains enumerated lists of the units of measures for some data elements and allowable values for some data elements. For rules regarding the unit of measure or allowable values for a specific data element, please refer to the appropriate Data Element Definitions table.

The e-GGRT XML Reporting Schema is available for download at the e-GGRT help website: <http://www.ccdsupport.com/confluence/display/help/XML+Reporting+Instructions>. The zip file contains:

- **Schema zip file with the master GHG\_Final\_vN.n.xsd and supporting subpart and component xsd files for the current reporting year.**
- **Schema change log files and year to year comparison reports.**

**Table 1**  
**Reporting Numbers**

Number Format	Description
Rounding	<ul style="list-style-type: none"> <li>• CO<sub>2</sub>e and CO<sub>2</sub> emissions data expressed in metric tons should be rounded to one decimal place. This should be done regardless of the level of data collection (e.g., unit-level, facility-level). Quantities less than 0.05 metric tons would round to 0.0 and be reported as such. Quantities greater than or equal to 0.05 metric tons would round up to 0.1 and be reported as such.</li> <li>• CH<sub>4</sub> emissions data expressed in metric tons should be rounded to two decimal places.</li> <li>• N<sub>2</sub>O emissions data expressed in metric tons should be rounded to three decimal places.</li> <li>• Emissions data for all GHGs other than CO<sub>2</sub>, N<sub>2</sub>O and CH<sub>4</sub> expressed in metric tons should be rounded to the fourth digit to the right of the decimal (one tenth of a kilogram, or 1 ten thousandth of a metric ton). This rounding should be applied regardless of the level of data collection (unit, facility, etc.).</li> <li>• Other (non-emissions) quantitative data reported by the user (e.g., a monthly HHV sample result, an annual production quantity) will not need to be rounded.</li> <li>• In the case of aggregation/roll-ups, those calculations should be performed on the rounded values.</li> </ul>
Percentages	If a value must be reported as a percentage, then the number should be within the range of 0 to 100 (percent), e.g. 85.5% should be reported as 85.5.
Fractions	If a value must be reported as a decimal fraction, then the number should be within the range of 0 and 1, e.g., 1/4 should be reported as 0.25. Leading zeroes are optional.

### Key XML Terms

- XML: A markup language for documents containing structured information. The XML specification defines a standard way to add markup to documents. Its primary purpose is to facilitate the sharing of structured data across different information systems, particularly via the internet.
- XML Schema: An XML schema describes the structure of an XML document. The schema also defines the set of rules to which the XML document must conform in order to be considered "valid".
- XML file: A file containing data organized into a structured document using XML markup.



- **Data Element:** An XML data element is used for storing and classifying data in an XML file. Opening and closing tags represent the start and end of a data element. An opening tag looks like <elementName>, while a closing tag has a slash that is placed before the element's name </elementName>. The following example shows how to report the facility's identification number: <FacilitySiteIdentifier>23222</FacilitySiteIdentifier>. The information shaded in blue represents the data element's value.

If a data element does not contain a value, then a single empty tag name may be used. An empty tag has a slash placed after the element's name <FacilitySiteIdentifier/>. **Note:** If you do not intend to report a value for a particular data element, then it is recommended that you do not include the data element in the XML file.

- **Attribute:** An XML attribute contains additional information about a specific data element. An attribute for a data element is placed within the opening tag. The syntax for including an attribute in an element is <elementName attributeName="value">. For example, <TotalCH4CombustionEmissionsmassUOM="Metric Tons">.
- **Root/Parent/Child Element:** The schema's structure can be thought of as a family tree. At the top of the tree is some early ancestor and at the bottom of the tree are the latest children. With a tree structure you can see which children belong to which parents and many other relationships.

XML data elements are sometimes referenced in terms of how they relate to each other, e.g., parent-child relationships, within the schema's tree structure, also known as hierarchy. The top of the XML tree is considered the root – it is the parent to all data elements within the schema. In the example below, "GHG\_Unit\_Details" is the root, and just like in many other family trees, there is more than one item with the same name (e.g., "Unit\_ID"). The easiest way to distinguish these items is by referencing them in terms of their parent-child relationships, e.g., NoCEMS /Unit\_ID vs. CEMS/Unit\_ID.

**Figure 1**  
**Example of an XML Tree**

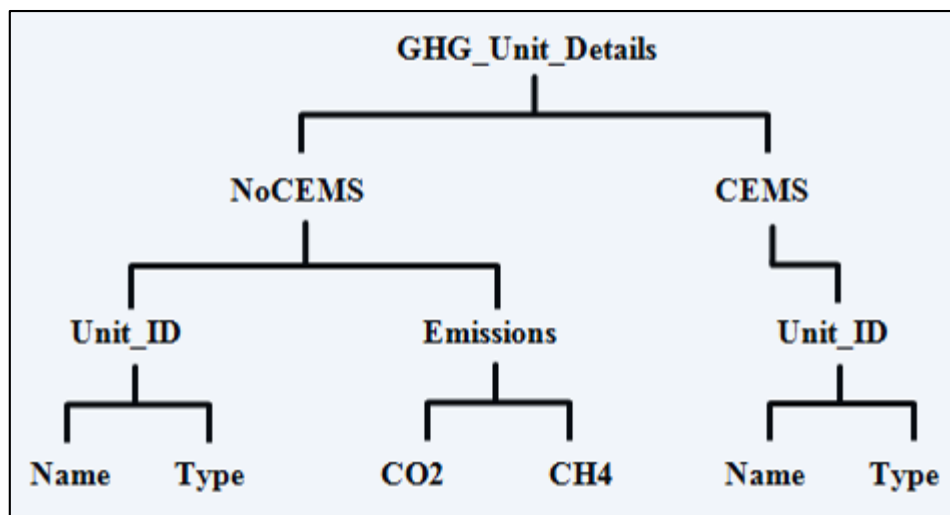

This document provides a step-by-step description of how to report emissions data using the XML schema. Please note the following:

- **Non-applicable data elements should not be included in the facility's XML file.** The schema contains many data elements, some of which may not be applicable to XML reporters in general or to a particular situation. If a data element is not referenced in the instructions (definition tables), then **do not** report or include it in the facility's XML file.
- **Data elements must be reported in a specific order.** The figures and tables in this document depict the specific sequence in which data elements must be arranged in the facility's XML file in order to produce a well-formed XML report.
- **Enumerations are case sensitive.** Many data elements have a defined set of allowable values, also known as enumerations. Values for enumerations must be entered exactly as they are defined within the schema (including punctuation marks) in order to be accepted by schema validation. See the definition tables for a complete list of enumerations.
- **Schema diagrams depict the hierarchy (or tree structure).** The primary purpose of the schema diagrams is to indicate the sequence in which data elements must appear within the facility's XML file and to identify the data elements that are required (must be reported) and conditionally required (see last bullet). Required data elements are boxed in red and conditionally required data elements are noted.
- **Definition tables provide details for required and conditionally required data elements.** The tables are designed to provide unique instructions for reporting a given data element, including the list of enumerations and required units of measure, if defined. As noted above, there are some data elements in the schema that are not applicable to XML reporters or to a particular situation. For example, the "OverrideIndicator" data element is used solely by e-GGRT to indicate that the web form reporter chose to override the system's calculated value with their own. These non-applicable data elements **are not** included in the definition tables. If a data element is not referenced in a definition table, then **do not** report or include it in the facility's XML file.
- **Commonly used data types are not depicted in the schema diagrams nor listed separately in the definition tables.** The schema diagrams display almost every data element in the schema except those that are associated with the three most commonly occurring data types:
  - Calculated Details
  - Measurement Details
  - Unit Identification Details

Once defined, these data types (static collection of data elements) are then associated as children to every data element in the schema containing a measured or calculated value or unit details. These child data elements do not appear in the diagrams and are not listed on separate rows in the definition tables in order to reduce their redundancy. They are however, referenced in the tables in the description of their parent data element. See Figures 2-4 and Tables 2-4.

- **Some data elements are conditionally required.** Data elements which are conditionally required are noted in the schema diagrams and the data element definitions tables. If your facility meets the condition specified for the data element, then the data element is required and you must report it in the facility's XML file. If your facility does not meet the condition specified for the data element, then **do not** include the data element in the facility's XML file. If a parent element is not required, then **do not** include any of its child data elements in the facility's XML file.

**Figure 2**  
**Calculated Details Data Type Schema Diagram**

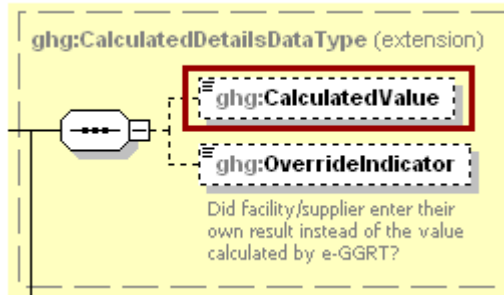

**Note:** Data elements boxed in red are required.

**Table 2**  
**Calculated Details Data Element Definitions**

Data Element Name	Description
<b>CalculatedDetailsDataType</b>	
CalculatedValue	Calculated value (decimal).
OverrideIndicator	<b>Note:</b> Do not include this data element in the facility’s XML file because it only applies to web form reporters. It is a flag set by e-GGRT to indicate that the system-calculated value was overridden with the web form reporter’s value.

**Figure 3**  
**Measurement Details Data Type Schema Diagram**

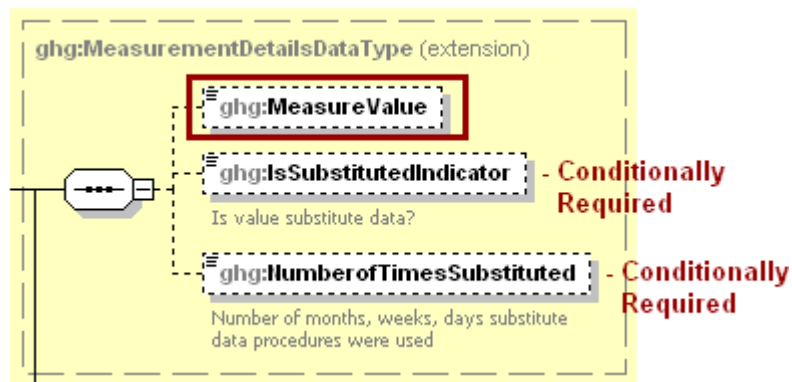

**Note:** Data elements boxed in red are required. Please see page 4 of this document for more information on conditionally required elements.

**Table 3**  
**Measurement Details Data Element Definitions**

Data Element Name	Description
<b>MeasurementDetailsDataType</b>	
Measure Value	Measured value (decimal).
IsSubstitutedIndicator	An indication (Y/N) that the measure value contains substituted data. <b>Note:</b> Do not include this data element in your XML file unless noted in the instructions for the particular measured value.
NumberOfTimesSubstituted	The number (integer) of days, months, weeks or hours in the reporting year that missing data procedures were followed. <b>Note:</b> Do not include this data element in your XML file unless noted in the instructions for the particular measured value.

**Figure 4**  
**Unit Identification Details Data Type Schema Diagram**

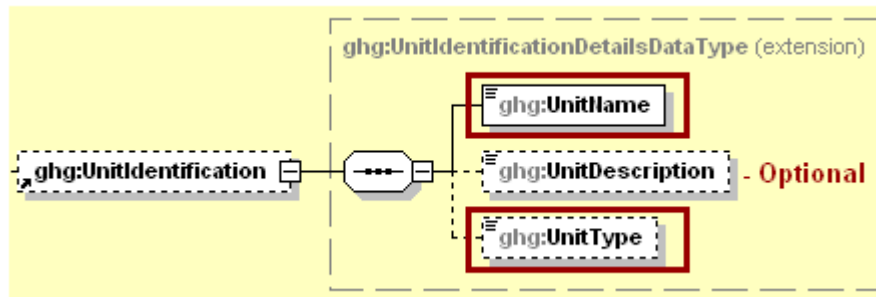

**Note:** Data elements boxed in red are required.

**Table 4**  
**Unit Identification Details Data Element Definitions**

Data Element Name	Description
<b>UnitIdentificationDetails</b>	
UnitName	A unique name (ID) for each unit so that the data for different units can be recorded, maintained and retrieved clearly.
UnitDescription	Optional brief description of the unit.
UnitType	The type of unit. The list of allowable values varies. For more information, see the instructions for the specific unit process to be reported. For example, if reporting Flare Gas details, the unit type would be “Flare”.

The XML symbol “1..∞” shown in Figure 5 means that the parent element is “unbounded” so that multiple instances of the parent element can be reported. XML Excerpt 1 shows an example of reporting multiple instances of a parent element.

**Figure 5**  
**“Unbounded” Symbol in Schema Diagram**

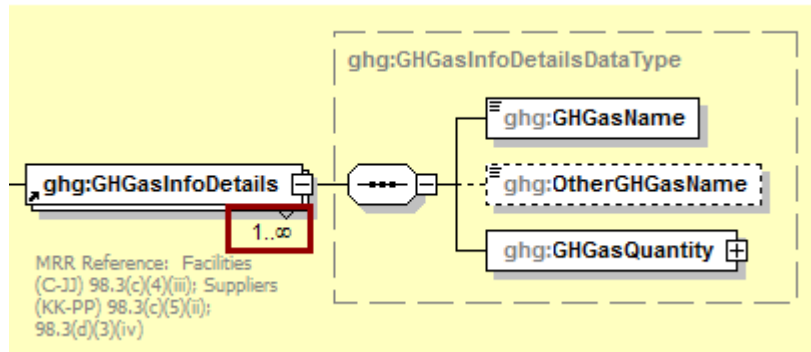

**XML Excerpt 1**  
**Example for “Unbounded” Parent Element**

```
<ghg:GHGasInfoDetails >
  <ghg:GHGasName>Carbon Dioxide </ghg:GHGasName>
  <ghg:GHGasQuantity massUOM="Metric Tons">
    <ghg:CalculatedValue>384781.2</ghg:CalculatedValue>
  </ghg:GHGasQuantity></ghg:GHGasInfoDetails>
<ghg:GHGasInfoDetails >
<ghg:GHGasInfoDetails >
  <ghg:GHGasName>Methane</ghg:GHGasName>
  <ghg:GHGasQuantity massUOM="Metric Tons">
    <ghg:CalculatedValue>4004.12</ghg:CalculatedValue>
  </ghg:GHGasQuantity></ghg:GHGasInfoDetails>
<ghg:GHGasInfoDetails >
```

**Note:** The code excerpt above is presented here to demonstrate the concept of reporting greenhouse gas quantity data.

The XML symbol for a logical “Or” shown in Figure 6 means that **only one** of the data elements following the symbol can be reported for the current instance of the parent element.

**Figure 6**  
**Logical “Or” Symbol in Schema Diagram**

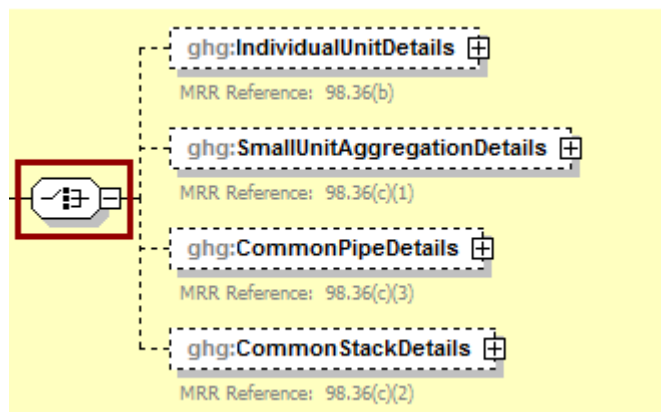

## **II. Summary of Changes**

There were not changes to the Subpart PP XML reporting schema for reporting year 2021.

Please note that example screen images and XML examples sourced from or labeled with a prior reporting year are accurate for Reporting Year 2021.

### III. Subpart PP Overview

This document provides a step-by-step description of how to report data for Subpart PP Suppliers of Carbon Dioxide and the overall total Subpart PP GHG data for a facility using the XML schema.

**Figure 7**  
**Subpart PP Reporting Diagram**  
**Suppliers of Carbon Dioxide**

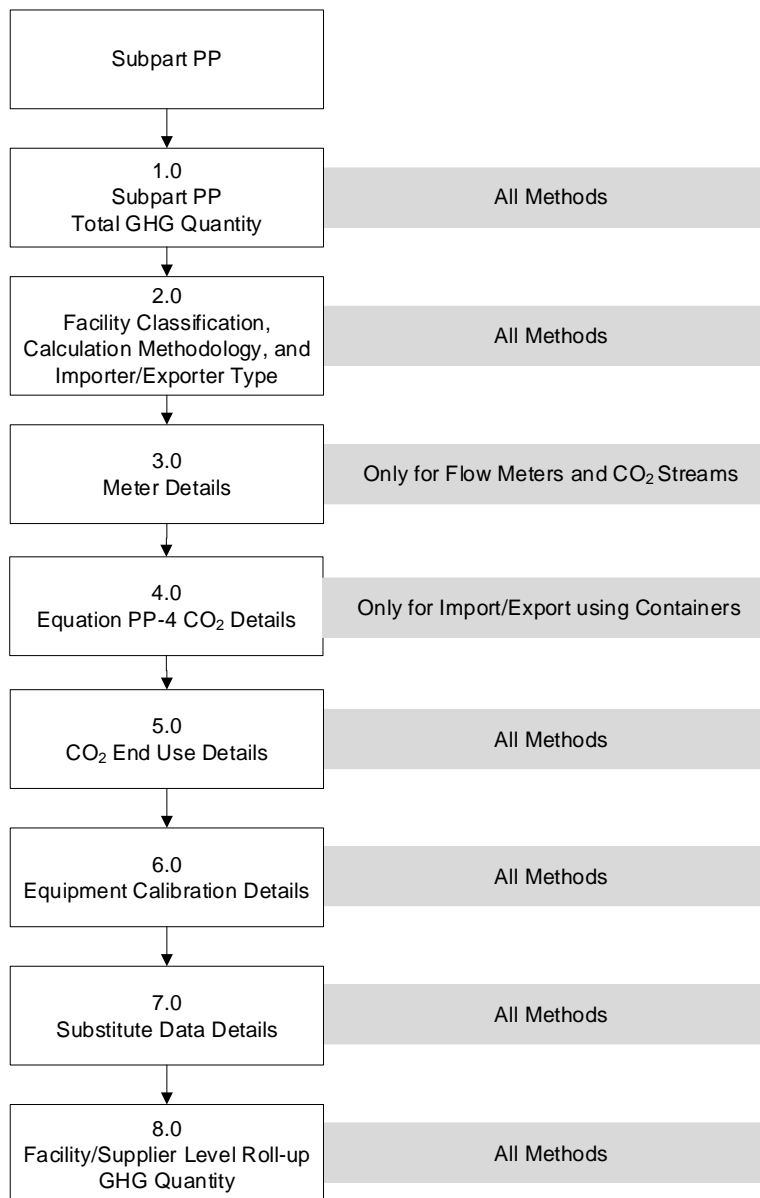

The XML schema includes the following areas for reporting for Subpart PP as shown in the reporting diagram:

- 1.0 Subpart PP Total GHG Quantity: includes how to report the total quantity of carbon dioxide.

- 2.0 Facility Classification, Calculation Methodology, and Importer/Exporter Type: includes facility/supplier classification, calculation methodology information, and importer/exporter classification.
- 3.0 Meter Details: includes flow meter and CO<sub>2</sub> stream information to report based on the facility/supplier classification and calculation methodology.
- 4.0 Equation PP-4 CO<sub>2</sub> Details: includes CO<sub>2</sub> GHG information to report if the facility imports or exports CO<sub>2</sub> in containers.
- 5.0 CO<sub>2</sub> End Use Details: includes CO<sub>2</sub> GHG information for each end-use application.
- 6.0 Equipment Calibration Details: includes equipment and calibration information for each type of equipment used to measure the total flow of the CO<sub>2</sub> stream or the total mass in CO<sub>2</sub> containers.
- 7.0 Substitute Data Details: includes information on the number of days substitute data was used to measure mass or volume, concentration and density.
- 8.0 Facility/Supplier Level Roll-up GHG Quantity: includes information on how to add GHG quantity data to facility level totals.

**NOTE:** If your facility is subject to reporting under Subpart PP (Suppliers of Carbon Dioxide), EPA recommends that you also consider the following source categories in your facility applicability determination:

- Subpart C (General Stationary Fuel Combustion),
- Subpart D (Electricity Generation),
- Subpart G (Ammonia Manufacturing),
- Subpart H (Cement Production),
- Subpart P (Hydrogen Production),
- Subpart Q (Iron and Steel Production),
- Subpart W (Petroleum and Natural Gas Systems),
- Subpart OO (Suppliers of Industrial Greenhouse Gases),
- Subpart RR (Geologic Sequestration of Carbon Dioxide) and
- Subpart UU (Injection of Carbon Dioxide).

These source categories are only provided as suggestions - additional Subparts may be relevant for a given facility/supplier and not all listed Subparts are relevant for all facilities/suppliers.



**Figure 8  
Subpart PP Schema Diagram**

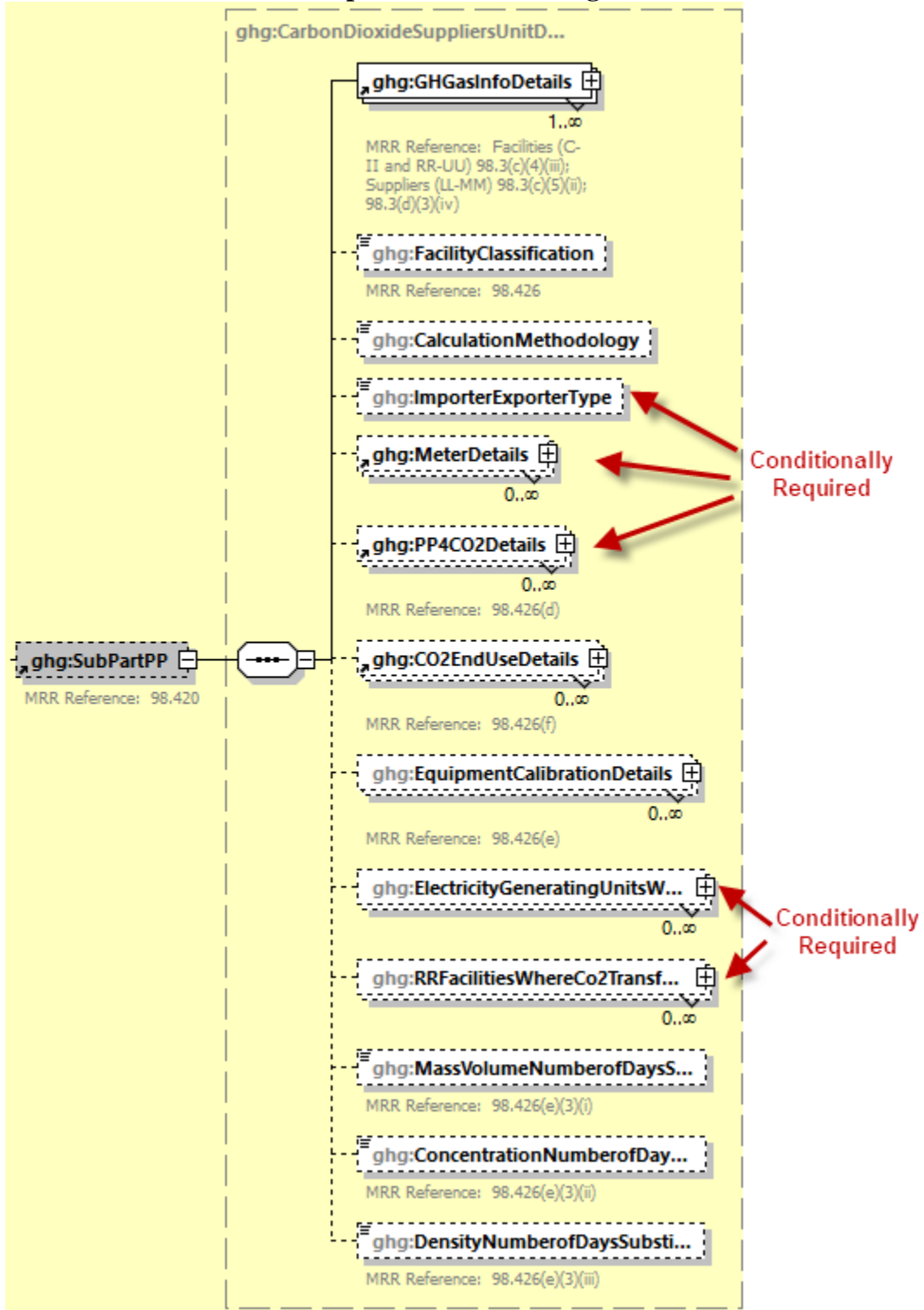

**Note:** Data elements boxed in red are required. Please see page 4 of this document for more information on conditionally required elements

### 1.0 Subpart PP Total GHG Quantity

Greenhouse gas information details comprise a collection of data elements to report the total annual greenhouse gas (GHG) quantity of each GHG listed in Table A-1 of 40 CFR 98 Mandatory Reporting of Greenhouse Gases reported under Subpart PP, expressed in metric tons.

**Figure 9  
Greenhouse Gas Information Details Schema Diagram**

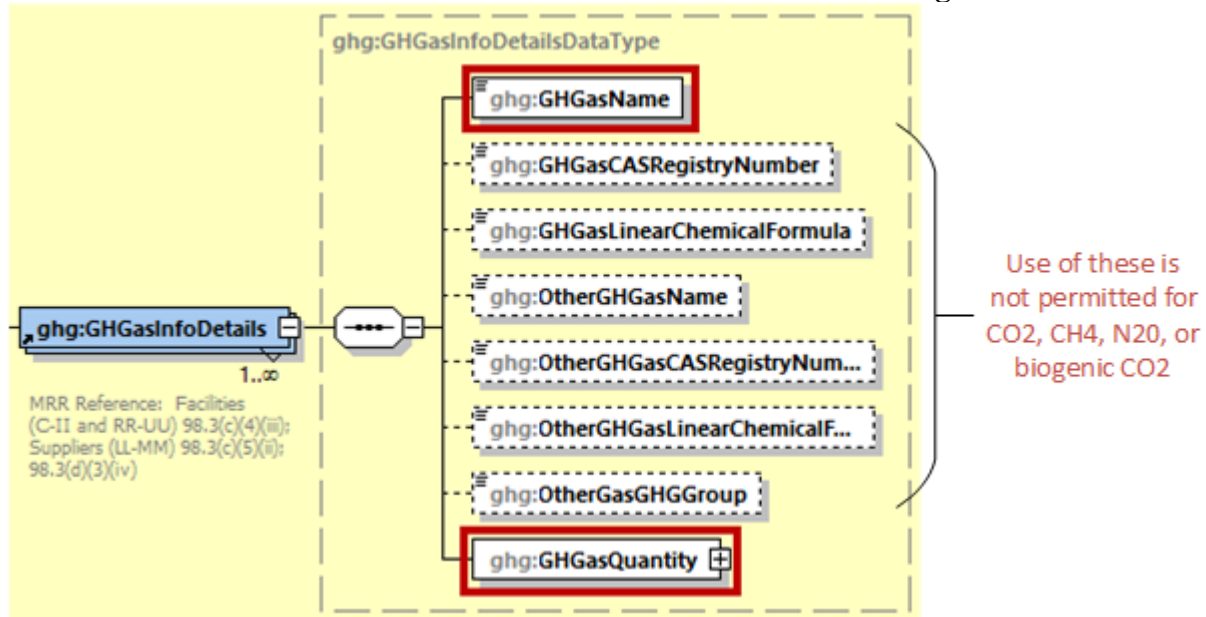

**Note:** Data elements boxed in red are required.

**Note:** You must follow the rounding rules found in [Table 1](#).

For Subpart PP, report the gas name and emissions for carbon dioxide (CO<sub>2</sub>); do **NOT** report the CAS Registry Number, Linear Chemical Formula, or the other gas data elements for CO<sub>2</sub>. For greenhouse gas quantity, report the calculated value and mass unit of measure (Metric Tons) only according to the following guidelines:

**Table 5**  
**Greenhouse Gas Information Details Data Element Definitions**

Data Element Name	Description
<b>GHGasInfoDetails</b>	<b>Parent Element:</b> A collection of data elements containing the total annual greenhouse gas quantity of each greenhouse gas (GHG) listed in Table A-1 of 40 CFR 98 Mandatory Reporting of Greenhouse Gases reported under this Subpart, expressed in metric tons.
GHGasName	Specify the name of the GHG: Carbon Dioxide
GHGasQuantity	A collection of data elements that quantify the annual greenhouse gas emissions from this supplier category. Report the value in the child data element <b>CalculatedValue</b> using the guidelines above. Set the units of measure to "Metric Tons" in the attribute <b>massUOM</b> .

**XML Excerpt 2**  
**Example for Greenhouse Gas Information Details**

```

<ghg:SubPartPP>
  <ghg:GHGasInfoDetails>
    <ghg:GHGasName>Carbon Dioxide</ghg:GHGasName>
    <ghg:GHGasQuantity massUOM="Metric Tons">
      <ghg:CalculatedValue>6269.4</ghg:CalculatedValue>
    </ghg:GHGasQuantity>
  </ghg:GHGasInfoDetails>

```

**Note:** The code excerpt above is presented here to demonstrate the concept of reporting greenhouse gas quantity data.

## 2.0 Facility Classification, Calculation Methodology, and Importer/Exporter Classification

The facility/supplier must report one of the following classifications to describe the facility/supplier [98.426]:

- **Capture Facility:** As required by 98.420(a)(1), a facility with production process units that capture a CO<sub>2</sub> stream for purposes of supplying CO<sub>2</sub> for commercial applications or that capture and maintain custody of a CO<sub>2</sub> stream in order to sequester or otherwise inject it underground. Capture refers to the initial separation and removal of CO<sub>2</sub> from a manufacturing process or any other process.
- **Extract Facility:** As required by 98.420(a)(2), a facility with CO<sub>2</sub> production wells that extract or produce a CO<sub>2</sub> stream for purposes of supplying CO<sub>2</sub> for commercial applications or that extract and maintain custody of a CO<sub>2</sub> stream in order to sequester or otherwise inject it underground.
- **Importer/Exporter:** As required by 98.420(a)(3).

The facility/supplier must report the calculation method used to estimate quantities of CO<sub>2</sub>. Subpart PP allows for different calculation methods based on the classification of the facility/supplier. Only the following facility classification and calculation methodology combinations may be reported:

(1) For a **Capture Facility**, the following calculation methods may be used:

- (a) **Flow Meters 1:** Flow Meters with no segregation or measurement is after segregation. Use Equation PP-1 or PP-2 for each meter and aggregate at the facility level using Equation PP-3a. [98.423(a)(3)(i)]
- (b) **Flow Meters 2:** Flow Meters with segregation or measurement is ahead of segregation. Use Equation PP-1 or PP-2 for each meter and aggregate at the facility level using Equation PP-3b. [98.423(a)(3)(ii)]
- (c) **Streams:** CO<sub>2</sub> that is supplied in containers. Use Equation PP-1 or PP-2 for each stream used to deliver CO<sub>2</sub> to a container and aggregate at the facility level using Equation PP-3a. CO<sub>2</sub> concentration measurement is required. [98.423(b)]
- (d) **Flow Meters 1 and Streams:** Flow Meters with no segregation or measurement is after segregation and CO<sub>2</sub> that is supplied in containers. Use Equation PP-1 or PP-2 for each meter or stream used to deliver CO<sub>2</sub> to a container and aggregate at the facility level using Equation PP-3a. [98.423(a)(3)(i) and 98.423(b)]

(2) For an **Extract Facility**, the following calculation methods may be used:

- (a) **Flow Meters 1:** Flow Meters with no segregation or measurement is after segregation. Use Equation PP-1 or PP-2 for each meter and aggregate at the facility level using Equation PP-3a. [98.423(a)(3)(i)]
- (b) **Flow Meters 3:** Flow Meters with no system aggregation Use Equation PP-1 or PP-2 for each meter and report supply data at the facility level.
- (c) **Streams:** CO<sub>2</sub> that is supplied in containers. Use Equation PP-1 or PP-2 for each stream used to deliver CO<sub>2</sub> to a container and aggregate at the facility level using Equation PP-3a. CO<sub>2</sub> concentration measurement is required. [98.423(b)]

(d) **Flow Meters 1 and Streams:** Flow Meters with no segregation or measurement is after segregation and CO<sub>2</sub> that is supplied in containers. Use Equation PP-1 or PP-2 for each meter or stream used to deliver CO<sub>2</sub> to a container and aggregate at the facility level using Equation PP-3a. [98.423(a)(3)(i) and 98.423(b)]

(3) For an **Importer or Exporter**, the following calculation methods may be used:

- (a) **Flow Meters 3:** Use Equation PP-1 or PP-2 for each meter and report supply data at the corporate level. (*Flow Meters 3*)
- (b) Import/Export **Containers:** Report supply results at the corporate level using Equation PP-4. This method assumes CO<sub>2</sub> concentration is 100%. [98.423(c)]

Facilities that are classified as an importer/exporter (98.420(a)(3)) must select one of the following three options: Importer, Exporter, or Importer and Exporter.

**Figure 10**  
**Facility Classification Schema Diagram**

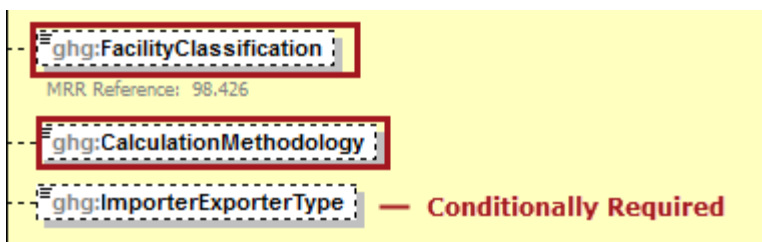

Note: Data elements boxed in red are required.

**Table 6**  
**Facility Classification Data Element Definitions**

Data Element Name	Description
FacilityClassification	An indication that the type of facility reporting is a capture facility, an extract facility, or an importer or exporter. See list of allowable values: <ul style="list-style-type: none"> <li>- capture 98.420(a)(1)</li> <li>- extract 98.420(a)(2)</li> <li>- import/export 98.420(a)(3)</li> </ul>
CalculationMethodology	Report the calculation methodology used. See list of allowable values: <ul style="list-style-type: none"> <li>- Flow Meters 1</li> <li>- Flow Meters 2</li> <li>- Flow Meters 3</li> <li>- Streams</li> <li>- Containers</li> <li>- Flow Meters 1 and Streams</li> </ul>

Data Element Name	Description
ImporterExporterType	<p><b>Conditionally Required:</b> If 'import/export' is indicated in the FacilityClassification data element, report the type of importer/exporter. See list of allowable values:</p> <ul style="list-style-type: none"> <li>- Importer</li> <li>- Exporter</li> <li>- Importer and Exporter</li> </ul>

**XML Excerpt 3  
Example for Facility Classification**

```

<ghg:FacilityClassification>capture 98.420(a)(1)</ghg:FacilityClassification>
<ghg:CalculationMethodology>Flow Meters 1</ghg:CalculationMethodology>
```

**Note:** The code excerpt above is presented here to demonstrate the concept of reporting greenhouse gas quantity data.

### 3.0 Meter Details

**Conditionally Required:** The facility/supplier must report meter details for all methods which use flow meters and CO<sub>2</sub> streams supplied in containers.

**Figure 11**  
**Meter Details Schema Diagram**

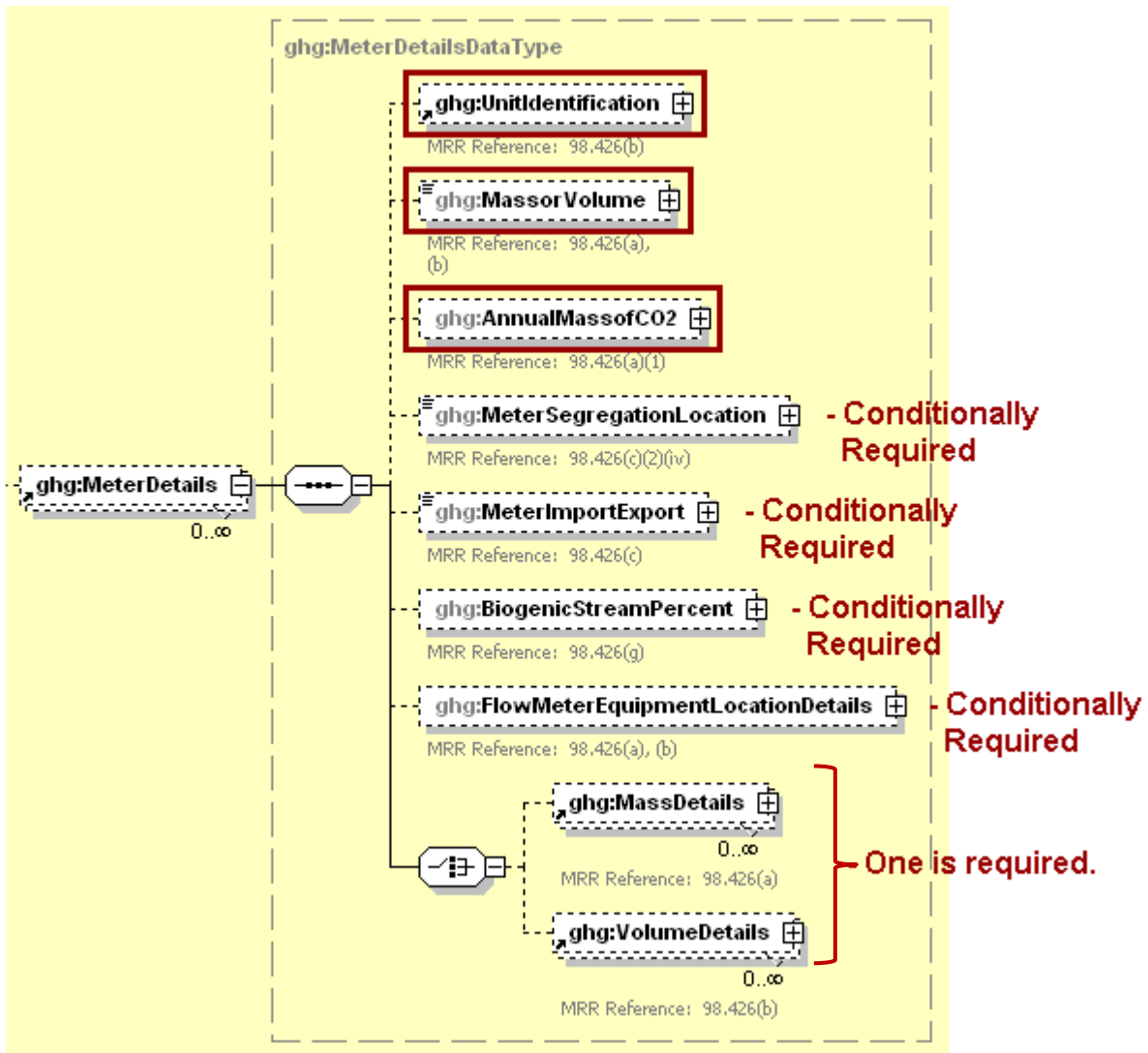

**Note:** Data elements boxed in red are required. Please see page 4 of this document for more information on conditionally required elements.

The following information is required for each individual flow meter/streams supplied in containers:

- A unique flow meter/stream name or ID, an optional description and the type of unit: "CO2 Flow Meter" or "CO2 Stream". Unit name must be unique within the subpart.
- An indication as to whether the flow meter/stream utilizes measurements on a mass or volumetric basis.
- Annual mass of CO<sub>2</sub> in metric tons, calculated using Equation PP-1 or PP-2.
- The location of the flow meter in relation to the point of segregation. This data is **conditionally required**: report only if a capture facility using calculation methodology Flow Meters 1 or Flow Meters 2; otherwise, do not include the data element in the XML file.
- An indication of whether the CO<sub>2</sub> metered by the specified flow meter was imported or exported. If report is not an importer or exporter report 'NA'. This data is **conditionally required**: report only if a capture facility using calculation methodology Flow Meters 1 or Flow Meters 2; otherwise, do not include the data element in the XML file.
- The percentage of the CO<sub>2</sub> stream metered by the flow meter that is biomass-based. This data is also **conditionally required**: report only if a capture facility; otherwise, do not include the data element in the XML file.

**Figure 12**  
**Meter Unit Identification and Information Schema Diagram**

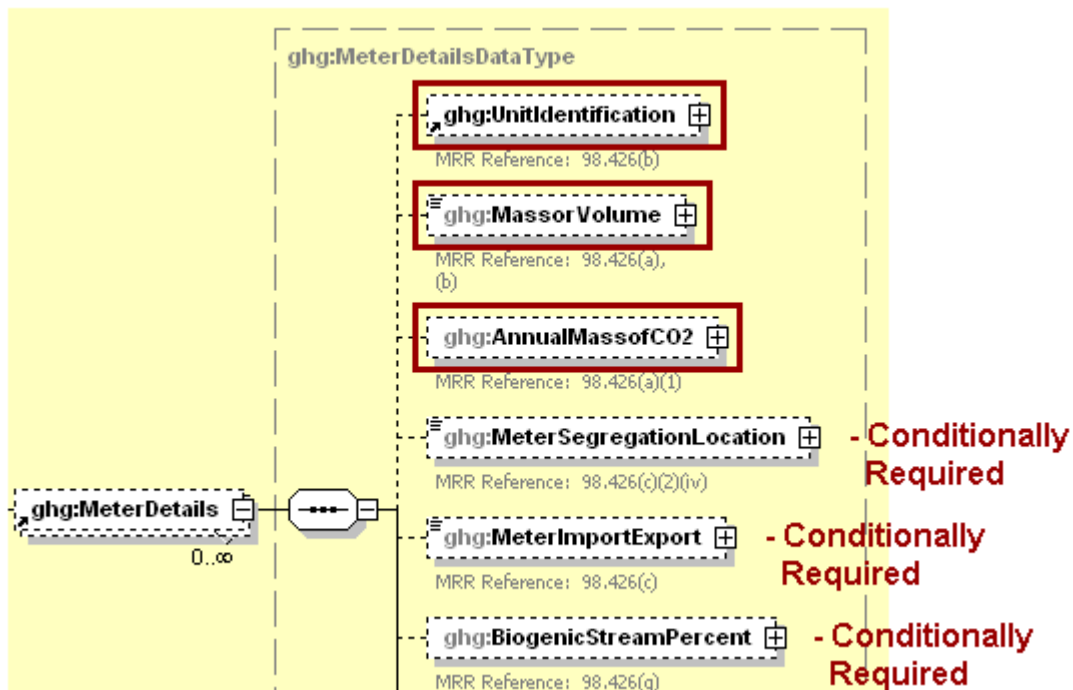

**Note:** Data elements boxed in red are required. Please see page 4 of this document for more information on conditionally required elements.



**Table 7**  
**Meter Unit Identification and Information Data Element Definitions**

Data Element Name	Description
<b>MeterDetails</b>	<b>Parent Element (Conditionally Required):</b> A collection of data elements to report about each flow meter used to measure CO <sub>2</sub> and each CO <sub>2</sub> stream that supplies CO <sub>2</sub> in containers.
UnitIdentification	A collection of data elements containing the identity of each flow meter or CO <sub>2</sub> stream. Report a unique unit name (ID) in the child data element <b>UnitName</b> , an optional brief description in the child data element <b>UnitDescription</b> and the type of unit in the child data element <b>UnitType</b> : "CO <sub>2</sub> Flow Meter" or "CO <sub>2</sub> Stream". Unit name must be unique within the subpart.
MassorVolume	Indicate the measurement type of the specified flow meter or CO <sub>2</sub> stream. See list of allowable values:  Mass Volumetric - concentration in weight percentage Volumetric - concentration in volume percentage
AnnualMassofCO2	A collection of data elements containing the total annual mass of CO <sub>2</sub> in metric tons calculated using Equation PP-1 or PP-2. Report the value in the child data element <b>MeasureValue</b> . Set the units of measure to "Metric Tons" in the attribute <b>massUOM</b> .
MeterSegregationLocation	<b>Conditionally Required:</b> If the capture facility/supplier reports the flow meter calculation method described in 98.423(a)(3)(ii) (Equation PP-3b) (Flow Meters 2), report the location (upstream or downstream) of the specified flow meter in relation to the point of segregation. Capture facilities reporting using the Flow Meters 1 method report 'NA'. Other facilities may omit this item. See list of allowable values:  UpStream DownStream NA
MeterImportExport	<b>Conditionally Required:</b> If the facility/supplier is an importer or exporter of bulk CO <sub>2</sub> , indicate whether the CO <sub>2</sub> metered by the specified flow meter was imported or exported. If a facility is not an importer or exporter report 'NA'. See list of allowable values:  Import Export NA
BiogenicStreamPercent	<b>Conditionally Required:</b> A collection of data elements containing the percentage of the CO <sub>2</sub> stream metered by the flow meter that is biomass-based. Report only if the facility is a capture facility. Report the value in the child data element <b>MeasureValue</b> .

### Example for Meter Unit Identification and Information for Capture Facility

```

<ghg:MeterDetails>
  <ghg:UnitIdentification>
    <ghg:UnitName>001</ghg:UnitName>
    <ghg:UnitDescription>Mass basis flow meter</ghg:UnitDescription>
    <ghg:UnitType>CO2 Flow Meter</ghg:UnitType>
  </ghg:UnitIdentification>
  <ghg:MassorVolume>Mass</ghg:MassorVolume>
  <ghg:AnnualMassofCO2 massUOM="Metric Tons">
    <ghg:MeasureValue>700.4</ghg:MeasureValue>
  </ghg:AnnualMassofCO2>
  <ghg:MeterSegregationLocation>UpStream</ghg:MeterSegregationLocation>
  <ghg:MeterImportExport>NA</ghg:MeterImportExport>
  <ghg:BiogenicStreamPercent>
    <ghg:MeasureValue>10.6</ghg:MeasureValue>
  </ghg:BiogenicStreamPercent>

```

**Note:** The code excerpt above is presented here to demonstrate the concept of reporting greenhouse gas quantity data.

### XML Excerpt 4 Example for Meter Unit Identification and Information for Exporter

```

<ghg:MeterDetails>
  <ghg:UnitIdentification>
    <ghg:UnitName>002</ghg:UnitName>
    <ghg:UnitDescription>export flow meter</ghg:UnitDescription>
    <ghg:UnitType>CO2 Flow Meter</ghg:UnitType>
  </ghg:UnitIdentification>
  <ghg:MassorVolume>Volumetric - concentration in weight percentage</ghg:MassorVolume>
  <ghg:AnnualMassofCO2 massUOM="Metric Tons">
    <ghg:MeasureValue>2270.9</ghg:MeasureValue>
  </ghg:AnnualMassofCO2>
  <ghg:MeterImportExport>Export</ghg:MeterImportExport>

```

**Note:** The code excerpt above is presented here to demonstrate the concept of reporting greenhouse gas quantity data.

**Conditionally Required:** Flow meter equipment location details must be reported if a flow meter was used. This section does not apply to CO<sub>2</sub> streams supplied in containers.

**Figure 13**  
**Flow Meter Equipment Location Details Schema Diagram**

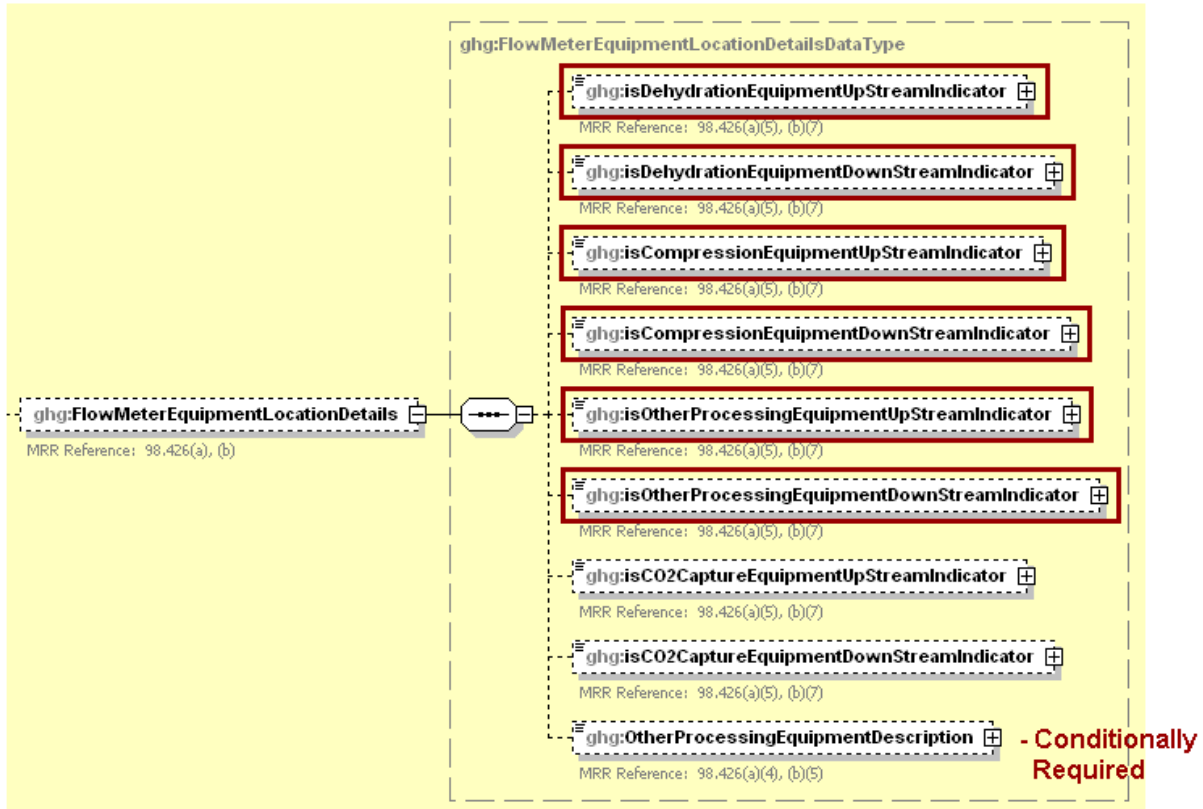

**Note:** Data elements boxed in red are required. Please see page 4 of this document for more information on conditionally required elements.

For the flow meter specified, indicate the location of the flow meter in relation to the following:

- Dehydration equipment.
- Compression equipment.
- Other processing equipment.

**Note:** Do not report the location of CO<sub>2</sub> capture equipment.

For each flow meter in which the facility/supplier indicates that “other processing equipment” is located upstream and/or downstream of the meter, describe any other processing equipment present. If you have more than one type of other processing equipment, describe each type, including whether it is upstream or downstream of the flow meter.

**Table 8  
Flow Meter Equipment Location Details Data Element Definitions**

Data Element Name	Description
<b>FlowMeterEquipmentLocationDetails</b>	<b>Parent Element (Conditionally Required):</b> A collection of data elements to report about the location of the specified flow meter in relation to processing equipment. This section does not apply to CO <sub>2</sub> streams supplied in containers.
isDehydrationEquipmentUpStreamIndicator	An indication (Y/N) if any dehydration equipment is located upstream of the flow meter.
isDehydrationEquipmentDownStreamIndicator	An indication (Y/N) if any dehydration equipment is located downstream of the flow meter.
isCompressionEquipmentUpStreamIndicator	An indication (Y/N) if any compression equipment is located upstream of the flow meter.
isCompressionEquipmentDownStreamIndicator	An indication (Y/N) if any compression equipment is located downstream of the flow meter.
isOtherProcessingEquipmentUpStreamIndicator	An indication (Y/N) if any other processing equipment is located upstream of the flow meter.
isOtherProcessingEquipmentDownStreamIndicator	An indication (Y/N) if any other processing equipment is located downstream of the flow meter.
OtherProcessingEquipmentDescription	<b>Conditionally Required:</b> Describe what other processing equipment is present, if applicable. If there is more than one type, indicate for each type if it is upstream or downstream from the flow meter.

**XML Excerpt 5  
Example for Flow Meter Equipment Location Details**

```

<ghg:FlowMeterEquipmentLocationDetails>
  <ghg:isDehydrationEquipmentUpStreamIndicator>N</ghg:isDehydrationEquipmentUpStreamIndicator>
  <ghg:isDehydrationEquipmentDownStreamIndicator>Y</ghg:isDehydrationEquipmentDownStreamIndicator>
  <ghg:isCompressionEquipmentUpStreamIndicator>N</ghg:isCompressionEquipmentUpStreamIndicator>
  <ghg:isCompressionEquipmentDownStreamIndicator>Y</ghg:isCompressionEquipmentDownStreamIndicator>
  <ghg:isOtherProcessingEquipmentUpStreamIndicator>N</ghg:isOtherProcessingEquipmentUpStreamIndicator>
  <ghg:isOtherProcessingEquipmentDownStreamIndicator>Y</ghg:isOtherProcessingEquipmentDownStreamIndicator>
  <ghg:OtherProcessingEquipmentDescription>Processing equipment description
</ghg:OtherProcessingEquipmentDescription>
</ghg:FlowMeterEquipmentLocationDetails>
    
```

**Note:** The code excerpt above is presented here to demonstrate the concept of reporting greenhouse gas quantity data.



**Which equation was used to calculate the annual mass of CO<sub>2</sub>?**

- If Equation PP-1 was used, see [Mass Details Schema Diagram](#) and instructions on how to report.
- If Equation PP-2 was used, see [Volume Details Schema Diagram](#) and instructions on how to report.

**Figure 14**  
**Mass Details Schema Diagram**

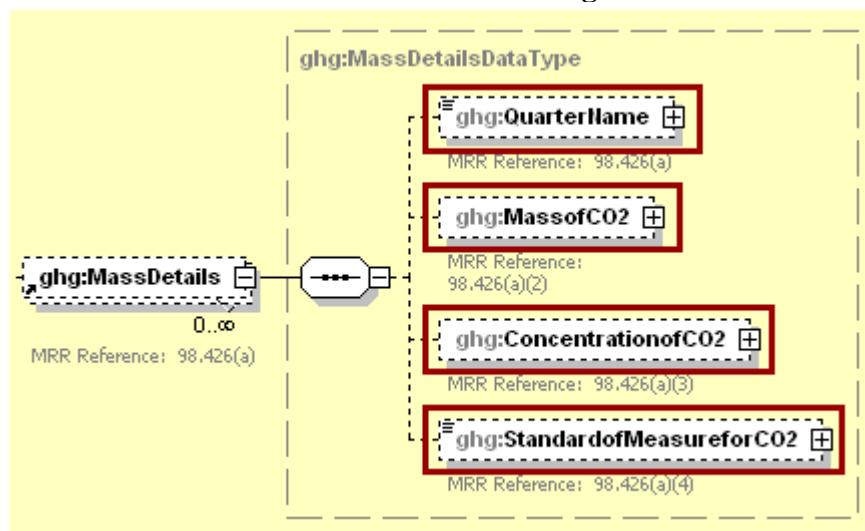

**Note:** Data elements boxed in red are required.

**Conditionally Required:** Mass details must be reported for each flow meter or CO<sub>2</sub> stream supplied in containers for which “Mass” was reported for measurement type. Use Equation PP-1 for mass-based measurements. For each quarter, report the following information:

- The mass of CO<sub>2</sub> stream in metric tons.
- The concentration of CO<sub>2</sub> stream in weight percent CO<sub>2</sub>.
- The name of the standard used to measure CO<sub>2</sub> concentration.

For any quarter in which CO<sub>2</sub> was not supplied, report a value of “0” for both the mass and concentration.

**Table 9**  
**Mass Details Data Element Definitions**

Data Element Name	Description
<b>MassDetails</b>	<b>Parent Element (Conditionally Required):</b> A collection of data elements to report if the measurement type of the specified flow meter or CO <sub>2</sub> streams supplied in containers is mass basis.
QuarterName	Quarter name. See list of allowable values:  First Quarter Second Quarter Third Quarter Fourth Quarter

Data Element Name	Description
MassofCO2	A collection of data elements containing information on the mass of the CO <sub>2</sub> stream for the specified quarter. Report the value in the child data element <b>MeasureValue</b> . Set the units of measure to “Metric Tons” in the attribute <b>massUOM</b> .
ConcentrationofCO2	A collection of data elements containing information on the concentration of the CO <sub>2</sub> stream for the specified quarter in weight percent of CO <sub>2</sub> . Report the value in the child data element <b>MeasureValue</b> . Set the units of measure to “fraction (number between 0 and 1)” in the attribute <b>fractionUOM</b> .
StandardofMeasureforCO2	The standard used to measure the concentration of the CO <sub>2</sub> stream for the specified quarter.

### XML Excerpt 6 Example for Mass Details

```

<ghg:MassDetails>
  <ghg:QuarterName>First Quarter</ghg:QuarterName>
  <ghg:MassofCO2 massUOM="Metric Tons">
    <ghg:MeasureValue>1101.2444</ghg:MeasureValue>
  </ghg:MassofCO2>
  <ghg:ConcentrationofCO2 fractionUOM="fraction (number between 0 and 1)">
    <ghg:MeasureValue>0.5</ghg:MeasureValue>
  </ghg:ConcentrationofCO2>
  <ghg:StandardofMeasureforCO2>Standard H</ghg:StandardofMeasureforCO2>
</ghg:MassDetails>
<ghg:MassDetails>
  <ghg:QuarterName>Second Quarter</ghg:QuarterName>
  <ghg:MassofCO2 massUOM="Metric Tons">
    <ghg:MeasureValue>2200.64466</ghg:MeasureValue>
  </ghg:MassofCO2>
  <ghg:ConcentrationofCO2 fractionUOM="fraction (number between 0 and 1)">
    <ghg:MeasureValue>0.6</ghg:MeasureValue>
  </ghg:ConcentrationofCO2>
  <ghg:StandardofMeasureforCO2>Standard H</ghg:StandardofMeasureforCO2>
</ghg:MassDetails>
<ghg:MassDetails>
  <ghg:QuarterName>Third Quarter</ghg:QuarterName>
  <ghg:MassofCO2 massUOM="Metric Tons">
    <ghg:MeasureValue>3300.42232</ghg:MeasureValue>
  </ghg:MassofCO2>
  <ghg:ConcentrationofCO2 fractionUOM="fraction (number between 0 and 1)">
    <ghg:MeasureValue>0.7</ghg:MeasureValue>
  </ghg:ConcentrationofCO2>
  <ghg:StandardofMeasureforCO2>Standard H</ghg:StandardofMeasureforCO2>
</ghg:MassDetails>
<ghg:MassDetails>
  <ghg:QuarterName>Fourth Quarter</ghg:QuarterName>
  <ghg:MassofCO2 massUOM="Metric Tons">
    <ghg:MeasureValue>4400.82223</ghg:MeasureValue>
  </ghg:MassofCO2>
  <ghg:ConcentrationofCO2 fractionUOM="fraction (number between 0 and 1)">
    <ghg:MeasureValue>0.8</ghg:MeasureValue>
  </ghg:ConcentrationofCO2>
  <ghg:StandardofMeasureforCO2>Standard H</ghg:StandardofMeasureforCO2>
</ghg:MassDetails>
</ghg:MeterDetails>

```

**Note:** The code excerpt above is presented here to demonstrate the concept of reporting greenhouse gas quantity data.

**Figure 15**  
**Volume Details Schema Diagram**

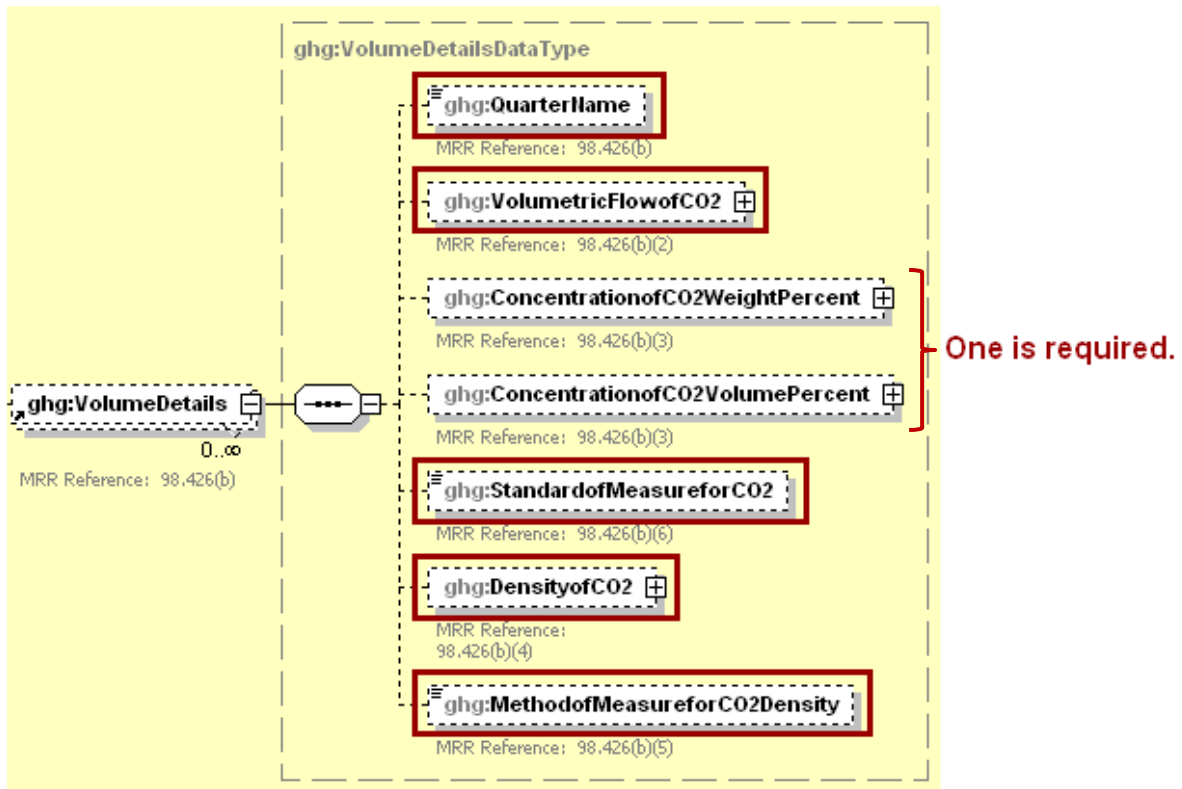

**Note:** Data elements boxed in red are required. Please see page 4 of this document for more information on conditionally required elements.

**Conditionally Required:** Volume details must be reported for each flow meter or CO<sub>2</sub> stream supplied in containers for which “Volumetric - concentration in weight percentage” or “Volumetric - concentration in volume percentage” was reported for the data element “MassorVolume”. Use Equation PP-2 for volume-based measurements. For each quarter, report the following information:

- The volume of CO<sub>2</sub> stream in standard cubic meters.
- The concentration of CO<sub>2</sub> stream in weight percent CO<sub>2</sub> or volume percent CO<sub>2</sub>.
- The name of the standard used to measure CO<sub>2</sub> concentration.
- The density. If reporting concentration in volume percentage, report the density of CO<sub>2</sub> that is required in the rule: 0.001868 metric tons per standard cubic meter. If reporting concentration in weight percentage, report the density of the CO<sub>2</sub> stream as measured.
- The method used to measure density. If reporting concentration in volume percentage, report “rule required density” as the standard.

For any quarter in which CO<sub>2</sub> was not supplied, report a value of “0” for both the volume and concentration.

**Table 10**  
**Volume Details Data Element Definitions**

Data Element Name	Description
<b>VolumeDetails</b>	<b>Parent Element (Conditionally Required):</b> A collection of data elements to report if the measurement type of the specified flow meter or CO <sub>2</sub> stream supplied in containers is volumetric basis (concentration in either weight or volume percentage).
QuarterName	Quarter name. See list of allowable values :  First Quarter Second Quarter Third Quarter Fourth Quarter
VolumetricFlowofCO2	A collection of data elements containing information on the volume of the CO <sub>2</sub> stream in the specified quarter. Report the value in the child data element <b>MeasureValue</b> . Set the units of measure to “Standard Cubic Meters” in the attribute <b>volUOM</b> .
ConcentrationofCO2WeightPercent	<b>Conditionally Required:</b> A collection of data elements containing information on the concentration of the CO <sub>2</sub> stream in weight percent. Report if the measurement type is “Volumetric - concentration in weight percentage”. Report the value in the child data element <b>MeasureValue</b> . Set the units of measure to “fraction (number between 0 and 1)” in the attribute <b>fractionUOM</b> .
ConcentrationofCO2VolumePercent	<b>Conditionally Required:</b> A collection of data elements containing information on the concentration of the CO <sub>2</sub> stream in volume percent. Report if the measurement type is “Volumetric - concentration in volume percentage”. Report the value in the child data element <b>MeasureValue</b> . Set the units of measure to “fraction (number between 0 and 1)” in the attribute <b>fractionUOM</b> .
StandardofMeasureforCO2	The standard used to measure CO <sub>2</sub> concentration for the quarter specified.
DensityofCO2	A collection of data elements containing information on the density of either CO <sub>2</sub> or the CO <sub>2</sub> stream for the quarter specified. If reporting concentration in volume percent, report the density of CO <sub>2</sub> that is required in the rule: 0.001868 metric tons per standard cubic meter. If reporting concentration in weight percent, report the density of the CO <sub>2</sub> stream. Report the value in the child data element <b>MeasureValue</b> . Set the units of measure to “mton/scm” in the attribute <b>densityUOM</b> .



Data Element Name	Description
MethodofMeasureforCO2Density	The method used to measure the density of CO <sub>2</sub> or of the CO <sub>2</sub> stream for the quarter specified. If reporting concentration in volume percent, report "rule required density".

### XML Excerpt 7 Example for Volume Details

```

<ghg:VolumeDetails>
  <ghg:QuarterName>First Quarter</ghg:QuarterName>
  <ghg:VolumetricFlowofCO2 volUOM="Standard Cubic Meters">
    <ghg:MeasureValue>1100.6234</ghg:MeasureValue>
  </ghg:VolumetricFlowofCO2>
  <ghg:ConcentrationofCO2VolumePercent fractionUOM="fraction (number between 0 and 1)">
    <ghg:MeasureValue>0.15</ghg:MeasureValue>
  </ghg:ConcentrationofCO2VolumePercent>
  <ghg:StandardofMeasureforCO2>Standard L</ghg:StandardofMeasureforCO2>
  <ghg:DensityofCO2 densityUOM="mton/scm">
    <ghg:MeasureValue>0.001868</ghg:MeasureValue>
  </ghg:DensityofCO2>
  <ghg:MethodofMeasureforCO2Density>rule required density</ghg:MethodofMeasureforCO2Density>
</ghg:VolumeDetails>
<ghg:VolumeDetails>
  <ghg:QuarterName>Second Quarter</ghg:QuarterName>
  <ghg:VolumetricFlowofCO2 volUOM="Standard Cubic Meters">
    <ghg:MeasureValue>1200.32345</ghg:MeasureValue>
  </ghg:VolumetricFlowofCO2>
  <ghg:ConcentrationofCO2VolumePercent fractionUOM="fraction (number between 0 and 1)">
    <ghg:MeasureValue>0.16</ghg:MeasureValue>
  </ghg:ConcentrationofCO2VolumePercent>
  <ghg:StandardofMeasureforCO2>Standard L</ghg:StandardofMeasureforCO2>
  <ghg:DensityofCO2 densityUOM="mton/scm">
    <ghg:MeasureValue>0.001868</ghg:MeasureValue>
  </ghg:DensityofCO2>
  <ghg:MethodofMeasureforCO2Density>rule required density</ghg:MethodofMeasureforCO2Density>
</ghg:VolumeDetails>
<ghg:VolumeDetails>
  <ghg:QuarterName>Third Quarter</ghg:QuarterName>
  <ghg:VolumetricFlowofCO2 volUOM="Standard Cubic Meters">
    <ghg:MeasureValue>1300.2322</ghg:MeasureValue>
  </ghg:VolumetricFlowofCO2>
  <ghg:ConcentrationofCO2VolumePercent fractionUOM="fraction (number between 0 and 1)">
    <ghg:MeasureValue>0.17</ghg:MeasureValue>
  </ghg:ConcentrationofCO2VolumePercent>
  <ghg:StandardofMeasureforCO2>Standard L</ghg:StandardofMeasureforCO2>
  <ghg:DensityofCO2 densityUOM="mton/scm">
    <ghg:MeasureValue>0.001868</ghg:MeasureValue>
  </ghg:DensityofCO2>
  <ghg:MethodofMeasureforCO2Density>rule required density</ghg:MethodofMeasureforCO2Density>
</ghg:VolumeDetails>
<ghg:VolumeDetails>
  <ghg:QuarterName>Fourth Quarter</ghg:QuarterName>
  <ghg:VolumetricFlowofCO2 volUOM="Standard Cubic Meters">
    <ghg:MeasureValue>1400.423442</ghg:MeasureValue>
  </ghg:VolumetricFlowofCO2>
  <ghg:ConcentrationofCO2VolumePercent fractionUOM="fraction (number between 0 and 1)">
    <ghg:MeasureValue>0.18</ghg:MeasureValue>
  </ghg:ConcentrationofCO2VolumePercent>
  <ghg:StandardofMeasureforCO2>Standard L</ghg:StandardofMeasureforCO2>
  <ghg:DensityofCO2 densityUOM="mton/scm">
    <ghg:MeasureValue>0.001868</ghg:MeasureValue>
  </ghg:DensityofCO2>
  <ghg:MethodofMeasureforCO2Density>rule required density</ghg:MethodofMeasureforCO2Density>
</ghg:VolumeDetails>
</ghg:MeterDetails>

```

**Note:** The code excerpt above is presented here to demonstrate the concept of reporting greenhouse gas quantity data.

#### 4.0 Equation PP-4 CO<sub>2</sub> Details

**Conditionally Required:** This section applies only to importers or exporters that imported or exported CO<sub>2</sub> in containers (and used Equation PP-4 to calculate the total mass of CO<sub>2</sub> - see 98.423(c)). Report the following information at the corporate level:

- Total annual mass of CO<sub>2</sub> in all containers imported according to Equation PP-4 in metric tons.
- Total annual mass of CO<sub>2</sub> in all containers exported according to Equation PP-4 in metric tons.

**Note:** Facilities/suppliers that did not import or export CO<sub>2</sub> in containers should not include the following data elements in the XML file (capture facilities, extract facilities and importers or exporters that used calculation methodology Flow Meters 3).

**Figure 16**  
Equation PP-4 CO<sub>2</sub> Details Schema Diagram

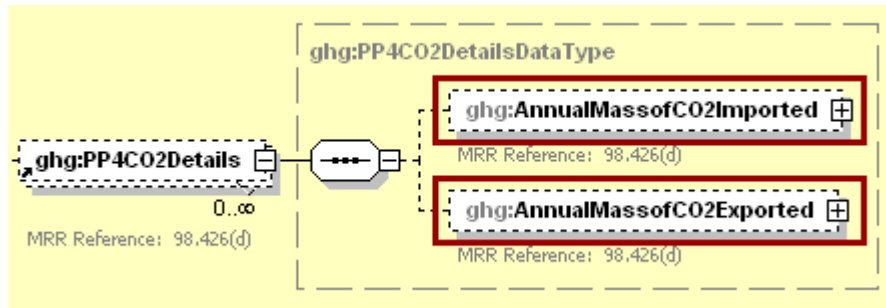

**Note:** Data elements boxed in red are required.

**Table 11**  
Equation PP-4 CO<sub>2</sub> Details Data Element Definitions

Data Element Name	Description
<b>PP4CO2Details</b>	<b>Parent Element (Conditionally Required):</b> A collection of data elements to report if CO <sub>2</sub> was imported or exported using the Containers calculation methodology.
AnnualMassofCO2Imported	A collection of data elements containing information on the annual mass of CO <sub>2</sub> in metric tons in all CO <sub>2</sub> containers that were imported at the corporate level. Report the value in the child data element <b>MeasureValue</b> . Set the units of measure to “Metric Tons” in the attribute <b>massUOM</b> .
AnnualMassofCO2Exported	A collection of data elements containing information on the annual mass of CO <sub>2</sub> in metric tons in all CO <sub>2</sub> containers that were exported the corporate level. Report the value in the child data element <b>MeasureValue</b> . Set the units of measure to “Metric Tons” in the attribute <b>massUOM</b> .

### XML Excerpt 8 Example for Equation PP-4 CO<sub>2</sub> Details

```
<ghg:PP4CO2Details>  
  <ghg:AnnualMassofCO2Imported massUOM="Metric Tons">  
    <ghg:CalculatedValue>1500.9</ghg:CalculatedValue>  
  </ghg:AnnualMassofCO2Imported>  
  <ghg:AnnualMassofCO2Exported massUOM="Metric Tons">  
    <ghg:CalculatedValue>15.2</ghg:CalculatedValue>  
  </ghg:AnnualMassofCO2Exported>  
</ghg:PP4CO2Details>
```

**Note:** The code excerpt above is presented here to demonstrate the concept of reporting greenhouse gas quantity data.

### 5.0 CO<sub>2</sub> End Use Details

Subpart PP requires all reporters to report the following information at the facility level; importers and exporters must report the information at the corporate level:

- The aggregated annual quantity of CO<sub>2</sub> transferred to each of the following end-use applications. Note that most applications can be used regardless of the reporting year. However, as indicated below, some options are applicable only to RY 2010 through RY 2012, while others apply to RY 2013 and forward.
  - Food and beverage
  - Industrial and municipal water/wastewater treatment
  - Metal fabrication, including welding and cutting
  - Greenhouse uses for plant growth
  - Fumigants (e.g., grain storage) and herbicides
  - Pulp and paper
  - Cleaning and solvent use
  - Fire fighting
  - Transportation and storage of explosives
  - *Enhanced oil and natural gas recovery\**
  - Injection of CO<sub>2</sub> for enhanced oil and natural gas recovery that is covered by 40 CFR Part 98, Subpart UU\*\*
  - *Long-term storage (sequestration)\**
  - Geologic sequestration of carbon dioxide that is covered by 40 CFR Part 98, Subpart RR\*\*
  - Research and development
  - *Other/unknown\**
  - Other\*\*
  - Unknown\*\*

\*Available only for RY 2010 through RY 2012

\*\*Available only for RY 2013 onward

- Whether the quantity of each end-use application was imported or exported. Report “All” if the facility is not an importer or exporter.

**Figure 17**  
**CO<sub>2</sub> End Use Details Schema Diagram**

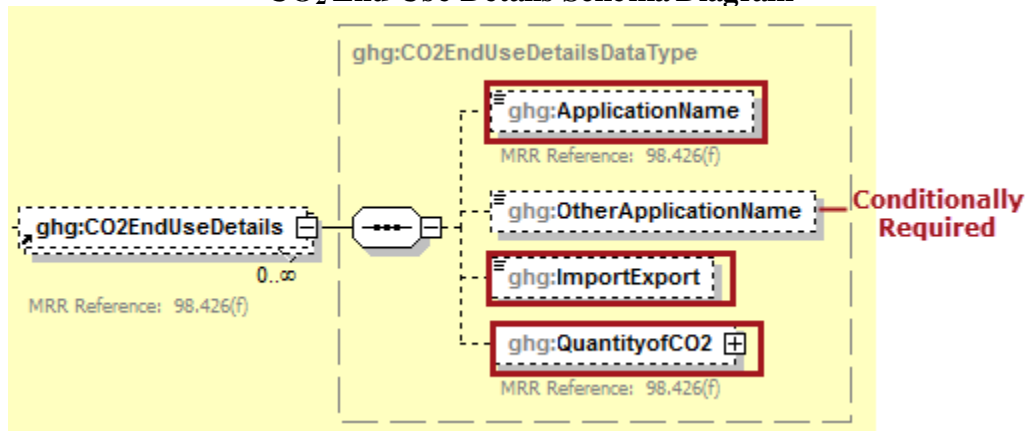

**Note:** Data elements boxed in red are required.

**Table 12**  
**CO<sub>2</sub> End Use Details Data Element Definitions**

Data Element Name	Description
<b>CO2EndUseDetails</b>	<b>Parent Element:</b> A collection of data elements to report about the aggregated annual quantity of CO <sub>2</sub> that is transferred to each end use application.
ApplicationName	<p>The name of the end use application. See list of allowable values (if not known, use the “Other/unknown” category):</p> <ul style="list-style-type: none"> <li>○ Food and beverage</li> <li>○ Industrial and municipal water/wastewater treatment</li> <li>○ Metal fabrication, including welding and cutting</li> <li>○ Greenhouse uses for plant growth</li> <li>○ Fumigants (e.g., grain storage) and herbicides</li> <li>○ Pulp and paper</li> <li>○ Cleaning and solvent use</li> <li>○ Fire fighting</li> <li>○ Transportation and storage of explosives</li> <li>○ Injection of CO<sub>2</sub> for enhanced oil and natural gas recovery that is covered by 40 CFR Part 98, Subpart UU*</li> <li>○ Geologic sequestration of carbon dioxide that is covered by 40 CFR Part 98, Subpart RR*</li> <li>○ Research and development</li> <li>○ Other (if other please provide a short description of the use)*</li> <li>○ Unknown*</li> </ul> <p>*Available only for RY 2013 onward</p>
OtherApplicationName	<b>Conditionally Required:</b> If the option “Other (if other please provide a short description of the use)” is selected for ApplicationName enter a short description of the use.
ImportExport	<p>Indicate if the specified end use application was imported or exported. If the facility is not an importer or exporter, report "All". See list of allowable values:</p> <ul style="list-style-type: none"> <li>○ Import</li> <li>○ Export</li> <li>○ All</li> </ul>
QuantityofCO2	A collection of data elements containing information on the aggregated annual quantity of CO <sub>2</sub> that is transferred to the specified end use application. Report the value in the child data element <b>MeasureValue</b> . Set the units of measure to “Metric Tons” in the attribute <b>massUOM</b> . Report a value of “0” for any end-use category for which your facility did not transfer CO <sub>2</sub> .

## XML Excerpt 9 Example for CO<sub>2</sub> End Use Details

```

<ghg:CO2EndUseDetails>
  <ghg:ApplicationName>Food and beverage</ghg:ApplicationName>
  <ghg:ImportExport>All</ghg:ImportExport>
  <ghg:QuantityofCO2 massUOM="Metric Tons">
    <ghg:MeasureValue>100.2245645</ghg:MeasureValue>
  </ghg:QuantityofCO2>
</ghg:CO2EndUseDetails>
<ghg:CO2EndUseDetails>
  <ghg:ApplicationName>Industrial and municipal water/wastewater treatment</ghg:ApplicationName>
  <ghg:ImportExport>All</ghg:ImportExport>
  <ghg:QuantityofCO2 massUOM="Metric Tons">
    <ghg:MeasureValue>200.48989</ghg:MeasureValue>
  </ghg:QuantityofCO2>
</ghg:CO2EndUseDetails>
<ghg:CO2EndUseDetails>
  <ghg:ApplicationName>Metal fabrication, including welding and cutting</ghg:ApplicationName>
  <ghg:ImportExport>All</ghg:ImportExport>
  <ghg:QuantityofCO2 massUOM="Metric Tons">
    <ghg:MeasureValue>300.823</ghg:MeasureValue>
  </ghg:QuantityofCO2>
</ghg:CO2EndUseDetails>
<ghg:CO2EndUseDetails>
  <ghg:ApplicationName>Greenhouse uses for plant growth</ghg:ApplicationName>
  <ghg:ImportExport>All</ghg:ImportExport>
  <ghg:QuantityofCO2 massUOM="Metric Tons">
    <ghg:MeasureValue>400.612323</ghg:MeasureValue>
  </ghg:QuantityofCO2>
</ghg:CO2EndUseDetails>
<ghg:CO2EndUseDetails>
  <ghg:ApplicationName>Fumigants (e.g., grain storage) and herbicides</ghg:ApplicationName>
  <ghg:ImportExport>All</ghg:ImportExport>
  <ghg:QuantityofCO2 massUOM="Metric Tons">
    <ghg:MeasureValue>500.31231</ghg:MeasureValue>
  </ghg:QuantityofCO2>
</ghg:CO2EndUseDetails>
<ghg:CO2EndUseDetails>
  <ghg:ApplicationName>Pulp and paper</ghg:ApplicationName>
  <ghg:ImportExport>All</ghg:ImportExport>
  <ghg:QuantityofCO2 massUOM="Metric Tons">
    <ghg:MeasureValue>600.1</ghg:MeasureValue>
  </ghg:QuantityofCO2>
</ghg:CO2EndUseDetails>
<ghg:CO2EndUseDetails>
  <ghg:ApplicationName>Cleaning and solvent use</ghg:ApplicationName>
  <ghg:ImportExport>All</ghg:ImportExport>
  <ghg:QuantityofCO2 massUOM="Metric Tons">
    <ghg:MeasureValue>700.5987</ghg:MeasureValue>
  </ghg:QuantityofCO2>
</ghg:CO2EndUseDetails>
<ghg:CO2EndUseDetails>
  <ghg:ApplicationName>Fire fighting</ghg:ApplicationName>
  <ghg:ImportExport>All</ghg:ImportExport>
  <ghg:QuantityofCO2 massUOM="Metric Tons">
    <ghg:MeasureValue>800.23453</ghg:MeasureValue>
  </ghg:QuantityofCO2>
</ghg:CO2EndUseDetails>

```

**Note:** The code excerpt above is presented here to demonstrate the concept of reporting greenhouse gas quantity data.

### 6.0 Equipment Calibration Details

Subpart PP requires all reporters to report the following information at the facility level; importers and exporters must report the information at the corporate level:

- Each type of equipment used to measure the total flow of the CO<sub>2</sub> stream.
- The standard used to operate and calibrate each type of equipment.

**Figure 18**  
**Equipment Calibration Details Schema Diagram**

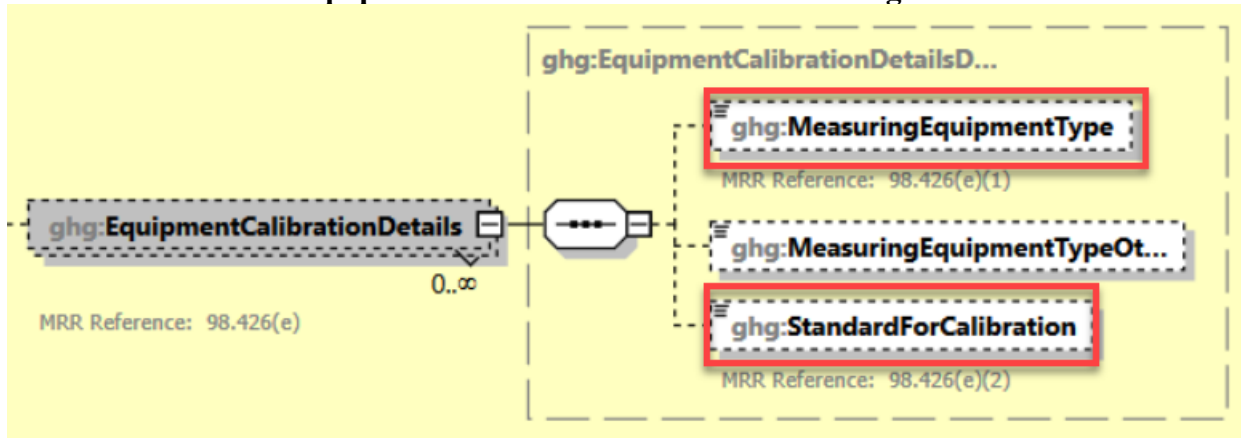

**Note:** Data elements boxed in red are required.

**Table 13**  
**Equipment Calibration Details Data Element Definitions**

Data Element Name	Description
<b>EquipmentCalibrationDetails</b>	<b>Parent Element:</b> A collection of data elements to report about the type of equipment used to measure the total flow of the CO <sub>2</sub> stream or the total mass or volume in CO <sub>2</sub> containers and the standard used to operate and calibrate the equipment.
MeasuringEquipmentType	The type of equipment used to measure the total flow of the CO <sub>2</sub> stream or the total mass or volume in CO <sub>2</sub> containers. See list of allowable values:  Mass flow meter Volumetric flow meter Scale Load cell Weigh bill Loaded container volume Other
MeasuringEquipmentTypeOther	<b>Conditionally Required:</b> description of equipment type if ‘Other’ is selected for MeasuringEquipmentType
StandardForCalibration	The standard used to operate and calibrate the specified equipment.

### XML Excerpt 10 Example for Equipment Calibration Details

```
<ghg:EquipmentCalibrationDetails>  
  <ghg:MeasuringEquipmentType>Mass flow meter</ghg:MeasuringEquipmentType>  
  <ghg:StandardForCalibration>Standard A</ghg:StandardForCalibration>  
</ghg:EquipmentCalibrationDetails>
```

**Note:** The code excerpt above is presented here to demonstrate the concept of reporting greenhouse gas quantity data.



## 7.0 Electricity Generating Unit Details

Beginning in RY2016, if you capture a CO<sub>2</sub> stream from an electricity generating unit that is subject to subpart D, Subpart PP requires that you report the facility identification number (GHGRP ID) and facility name associated with the annual GHG report for the subpart D facility or facilities.

**Figure 19**  
**Electricity Generating Unit Details Schema Diagram**  
**(Required for RY2016 Onward)**

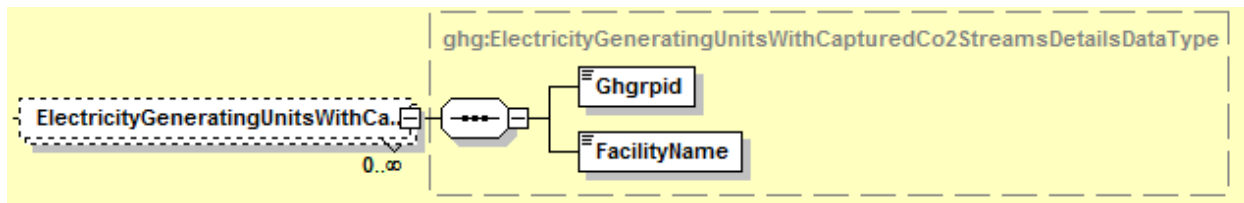

**Table 14**  
**Electricity Generating Unit Details Element Definitions**  
**(Required for RY2016 Onward)**

Data Element Name	Description
ElectricityGeneratingUnitsWithCapturedCo2Streams Details	<b>Parent Element:</b> A collection of data elements identifying facilities subject to Subpart D at which the reporter captures CO <sub>2</sub> from an electricity generating unit and transfers the CO <sub>2</sub> to a facility subject to Subpart RR
GHGRP ID	The six digit Greenhouse Gas Reporting Program identification number for the Subpart D facility
FacilityName	The name of the Subpart D facility

### XML Excerpt 11 Example for Electricity Generating Unit Details (Required for RY2016 Onward)

```
<ghg:ElectricityGeneratingUnitsWithCapturedCo2StreamsDetails >
  <ghg:GHGRPID>522796 </ghg:GHGRPID >
  <ghg:FacilityName>Dencore Generating Unit </ghg:FacilityName >
</ghg:ElectricityGeneratingUnitsWithCapturedCo2StreamsDetails >
```

**Note:** The code excerpt above is presented here to demonstrate the concept of reporting greenhouse gas quantity data.

### 8.0 Subpart RR Facility Where CO<sub>2</sub> Transferred Details

Beginning in RY2016, if you transfer CO<sub>2</sub> to any facilities that are subject to subpart RR, you must report each facility identification number (GHGRPID) associated with the annual GHG reports for each subpart RR facility to which CO<sub>2</sub> is transferred and the annual quantity of CO<sub>2</sub> in metric tons that is transferred to each subpart RR facility.

**Figure 20**  
**Subpart RR Facility Where CO<sub>2</sub> Transferred Details Schema Diagram**  
**(Required for RY2016 Onward)**

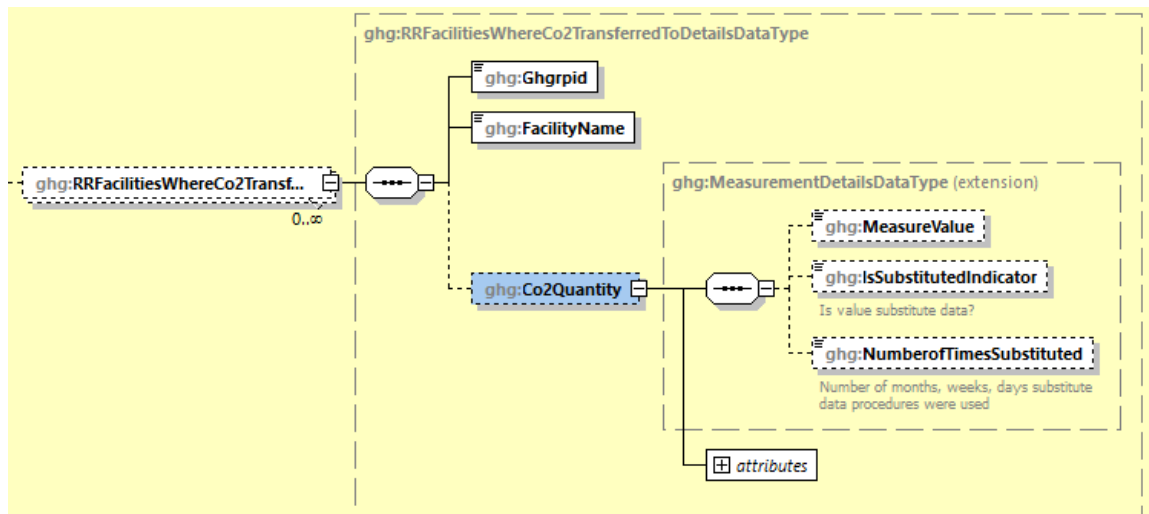

**Table 15**  
**Subpart RR Facility Where CO<sub>2</sub> Transferred Details Data Element Definitions**  
**(Required for RY2016 Onward)**

Data Element Name	Description
RRFacilitiesWhereCo2TransferredToDetails	<b>Parent Element:</b> A collection of data elements providing information on the transfer to Subpart RR facilities of CO <sub>2</sub> captured at an electricity generating unit subject to subpart D.
GHGRPID	The six digit Greenhouse Gas Reporting Program identification number for the Subpart RR facility
FacilityName	The name of the Subpart RR facility
CO2Quantity	A collection of data elements containing information on the aggregated annual quantity of CO <sub>2</sub> that is transferred to the specifieds Subpart RR facility. Report the value in the child data element <b>MeasureValue</b> . Set the units of measure to “Metric Tons” in the attribute <b>massUOM</b> .

**XML Excerpt 12**  
**Example for Subpart RR Facility Where CO<sub>2</sub> Transferred Details**  
**(Required for RY2016 Onward)**

```

<ghg:RRFacilitiesWhereCo2TransferredToDetails >
  <ghg:GHGRPID>566355</ghg:GHGRPID t>
  <ghg:FacilityName>First I njection</ghg:ApplicationName>
  <ghg:CO2Quantity massUOM="Metric Tons">
    <ghg:MeasureValue>500.31231</ghg:MeasureValue >
  </ghg:CO2Quantity>
</ghg:RRFacilitiesWhereCo2TransferredToDetails >
```

**Note:** The code excerpt above is presented here to demonstrate the concept of reporting greenhouse gas quantity data

### 9.0 Substitute Data Details

Subpart PP requires all reporters to report the following information at the facility level; importers and exporters must report the information at the corporate level:

- The number of days in the reporting year for which substitute data procedures were used to measure CO<sub>2</sub> mass or volume.
- The number of days in the reporting year for which substitute data procedures were used to measure CO<sub>2</sub> concentration.
- The number of days in the reporting year for which substitute data procedures were used to measure CO<sub>2</sub> stream density.

**Figure 21**  
**Substitute Data Details Schema Diagram**



**Note:** Data elements boxed in red are required.

**Table 16**  
**Substitute Data Details Data Element Definitions**

Data Element Name	Description
MassVolumeNumberofDaysSubstituted	The number of days in the reporting year for which substitute data procedures were used to measure the mass or volume (integer).
ConcentrationNumberofDaysSubstituted	The number of days in the reporting year for which substitute data procedures were used to measure the concentration (integer).
DensityNumberofDaysSubstituted	The number of days in the reporting year for which substitute data procedures were used to measure the density (integer).

**XML Excerpt 13**  
**Example for Substitute Data Details**

```

<ghg:MassVolumeNumberofDaysSubstituted>1</ghg:MassVolumeNumberofDaysSubstituted>
<ghg:ConcentrationNumberofDaysSubstituted>2</ghg:ConcentrationNumberofDaysSubstituted>
<ghg:DensityNumberofDaysSubstituted>3</ghg:DensityNumberofDaysSubstituted>
</ghg:SubPartPP>
    
```

**Note:** The code excerpt above is presented here to demonstrate the concept of reporting greenhouse gas quantity data.

### 10.0 Facility/Supplier Level Roll-up GHG Quantity

Each facility must report the following facility-level emission totals:

- Total CO<sub>2</sub> equivalent (CO<sub>2</sub>e) emissions (excluding biogenic CO<sub>2</sub>) aggregated across all direct emitter source categories (Subparts C-HH) associated with the facility.
- Total biogenic CO<sub>2</sub> emissions aggregated across all direct emitter source categories (Subparts C-HH) associated with the facility.

Each supplier must report the following supplier totals:

- Total CO<sub>2</sub>e associated with products supplied aggregated across Subparts LL, MM, NN, OO, PP, and QQ (as applicable).

**Figure 22**  
**Facility/Supplier Level Roll-up GHG Quantity Schema Diagram**

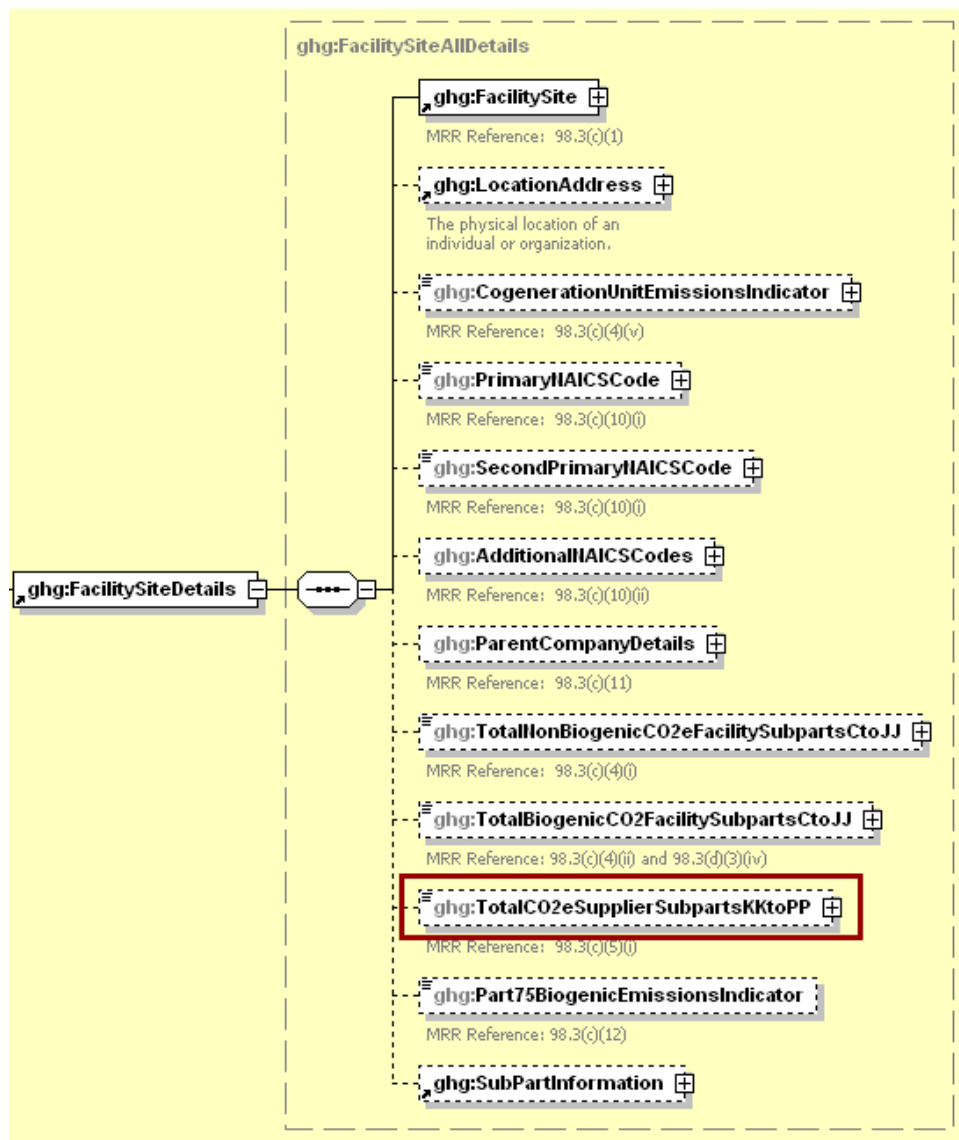

**Note:** Data elements boxed in red are required.

For Subpart PP, add the total quantity of carbon dioxide (CO<sub>2</sub>) to the total CO<sub>2</sub> equivalent (CO<sub>2</sub>e) quantity aggregated across all supplier category Subparts associated with the facility/supplier using the following guidelines:

- Capture: Add the annual mass of CO<sub>2</sub> across all flow meters/streams (result of Equation PP-3a or Equation PP-3b) in metric tons.
- Extract - Streams: Add the annual mass of CO<sub>2</sub> across all streams (result of Equation PP-3a) in metric tons.
- Extract- Flow Meter with No Aggregation: Add the total annual mass of CO<sub>2</sub> extracted (result of Equation PP-1 or PP-2 summed for all flow meters) in metric tons.
- Extract – Flow Meter with No System Segregation: Add the total annual mass of CO<sub>2</sub> across all flow meters (result of Equation PP-3a) in metric tons.
- Import/Export – Container Method: Add the annual mass of CO<sub>2</sub> in all containers imported in metric tons minus the annual mass of CO<sub>2</sub> in all containers exported (result of Equation PP-4) in metric tons.
- Import/Export – Flow Meter with No Aggregation: Add the annual mass of CO<sub>2</sub> imported total (result of Equation PP-1 or PP-2 summed for all import flow meters) in metric tons minus the annual mass of CO<sub>2</sub> exported total (result of Equation PP-1 or PP-2 summed for all export flow meters) in metric tons.

**Note:** You must follow the rounding rules found in [Table 1](#).

**Table 17  
Facility Level Roll-up GHG Quantity Data Element Definitions**

Data Element Name	Description
TotalCO <sub>2</sub> eSupplierSubpartsKKtoPP	Add the total CO <sub>2</sub> e value for Subpart PP in metric tons to the total CO <sub>2</sub> e quantity aggregated across all supplier category Subparts associated with the supplier according to the guidelines above. Set the units of measure to “Metric Tons” in the attribute <b>massUOM</b> .

**XML Excerpt 14  
Example for Facility Level Roll-up GHG Quantity**

```
<ghg:TotalCO2eSupplierSubpartsKKtoPP massUOM="Metric Tons">6753.4 </ghg:TotalCO2eSupplierSubpartsKKtoPP>
```

**Note:** The code excerpt above is presented here to demonstrate the concept of reporting greenhouse gas quantity data.

## IV. Appendix A Sample XML Documents for Subpart PP

### 1.0 Capture Facility – Flow Meters 1

#### [98.423(a)(3)(i)]

*(Note: Data values do not reflect an actual facility's emissions. Additional sample XML files for Subpart PP are posted on the e-GGRT help site.)*

```
<ghg:GHG xmlns="http://www.ccdsupport.com/schema/ghg">
  <ghg:FacilitySiteInformation>
    <ghg:CertificationStatement>The designated representative or alternate designated representative must sign (i.e., agree to) this certification statement. If you are an agent and you click on "SUBMIT", you are not agreeing to the certification statement, but are submitting the certification statement on behalf of the designated representative or alternate designated representative who is agreeing to the certification statement. An agent is only authorized to make the electronic submission on behalf of the designated representative, not to sign (i.e., agree to) the certification statement.</ghg:CertificationStatement>
    <ghg:ReportingYear>2019</ghg:ReportingYear>
    <ghg:FacilitySiteDetails>
      <ghg:FacilitySite>
        <ghg:FacilitySiteIdentifier>524117</ghg:FacilitySiteIdentifier>
        <ghg:FacilitySiteName>Capture- Flow Meters 1 TEST Facility</ghg:FacilitySiteName>
      </ghg:FacilitySite>
      <ghg:LocationAddress>
        <ghg:LocationAddressText>12600 S. ANY STREET</ghg:LocationAddressText>
        <ghg:LocalityName>CHICAGO</ghg:LocalityName>
        <ghg:StateIdentity>
          <ghg:StateCode>IL</ghg:StateCode>
        </ghg:StateIdentity>
        <ghg:AddressPostalCode>60633</ghg:AddressPostalCode>
      </ghg:LocationAddress>
      <ghg:CogenerationUnitEmissionsIndicator>N</ghg:CogenerationUnitEmissionsIndicator>
      <ghg:PrimaryNAICSCode>325120</ghg:PrimaryNAICSCode>
      <ghg:ParentCompanyDetails>
        <ghg:ParentCompany>
          <ghg:ParentCompanyLegalName>Soda Ash Corporation</ghg:ParentCompanyLegalName>
          <ghg:StreetAddress>108 Hillcrest Street</ghg:StreetAddress>
          <ghg:City>Sandpoint</ghg:City>
          <ghg:State>ID</ghg:State>
          <ghg:Zip>83864</ghg:Zip>
          <ghg:PercentOwnershipInterest>100.0</ghg:PercentOwnershipInterest>
        </ghg:ParentCompany>
      </ghg:ParentCompanyDetails>
      <ghg:TotalNonBiogenicCO2eFacilitySubpartsCtoJJ massUOM="Metric Tons">0</ghg:TotalNonBiogenicCO2eFacilitySubpartsCtoJJ>
      <ghg:TotalBiogenicCO2FacilitySubpartsCtoJJ massUOM="Metric Tons">0</ghg:TotalBiogenicCO2FacilitySubpartsCtoJJ>
      <ghg:TotalCO2eSupplierSubpartsKktoPP massUOM="Metric Tons">3122.4</ghg:TotalCO2eSupplierSubpartsKktoPP>
    <ghg:SubPartInformation>
      <ghg:SubPartPP>
        <ghg:GHGasInfoDetails>
          <ghg:GHGasName>Carbon Dioxide</ghg:GHGasName>
          <ghg:GHGasQuantity massUOM="Metric Tons">
            <ghg:CalculatedValue>3122.4</ghg:CalculatedValue>
          </ghg:GHGasQuantity>
        </ghg:GHGasInfoDetails>
      </ghg:SubPartPP>
    </ghg:SubPartInformation>
  </ghg:FacilitySiteInformation>
</ghg:GHG>
```

```

<ghg:FacilityClassification>capture 98.420(a)(1)</ghg:FacilityClassification>
<ghg:CalculationMethodology>Flow Meters 1</ghg:CalculationMethodology>
<ghg:MeterDetails>
  <ghg:UnitIdentification>
    <ghg:UnitName>003- Vol FM</ghg:UnitName>
    <ghg:UnitDescription>Volumetric basis (concentration in volume percentage) flow meter</ghg:UnitDescription>
    <ghg:UnitType>CO2 Flow Meter</ghg:UnitType>
  </ghg:UnitIdentification>
  <ghg:MassorVolume>Volumetric - concentration in volume percentage</ghg:MassorVolume>
  <ghg:AnnualMassofCO2 massUOM="Metric Tons">
    <ghg:MeasureValue>1868.3</ghg:MeasureValue>
  </ghg:AnnualMassofCO2>
  <ghg:MeterSegregationLocation>NA</ghg:MeterSegregationLocation>
  <ghg:MeterImportExport>NA</ghg:MeterImportExport>
  <ghg:BiogenicStreamPercent>
    <ghg:MeasureValue>30.36</ghg:MeasureValue>
  </ghg:BiogenicStreamPercent>
  <ghg:FlowMeterEquipmentLocationDetails>
    <ghg:isDehydrationEquipmentUpStreamIndicator>N</ghg:isDehydrationEquipmentUpStreamIndicator>
    <ghg:isDehydrationEquipmentDownStreamIndicator>Y</ghg:isDehydrationEquipmentDownStreamIndicator>
    <ghg:isCompressionEquipmentUpStreamIndicator>N</ghg:isCompressionEquipmentUpStreamIndicator>
    <ghg:isCompressionEquipmentDownStreamIndicator>Y</ghg:isCompressionEquipmentDownStreamIndicator>
    <ghg:isOtherProcessingEquipmentUpStreamIndicator>N</ghg:isOtherProcessingEquipmentUpStreamIndicator>
    <ghg:isOtherProcessingEquipmentDownStreamIndicator>Y</ghg:isOtherProcessingEquipmentDownStreamIndicator>
    <ghg:OtherProcessingEquipmentDescription>Processing equipment description K</ghg:OtherProcessingEquipmentDescription>
  </ghg:FlowMeterEquipmentLocationDetails>
  <ghg:VolumeDetails>
    <ghg:QuarterName>First Quarter</ghg:QuarterName>
    <ghg:VolumetricFlowofCO2 volUOM="Standard Cubic Meters">
      <ghg:MeasureValue>1111100.3435</ghg:MeasureValue>
    </ghg:VolumetricFlowofCO2>
    <ghg:ConcentrationofCO2VolumePercent fractionUOM="fraction (number between 0 and 1)">
      <ghg:MeasureValue>0.209</ghg:MeasureValue>
    </ghg:ConcentrationofCO2VolumePercent>
    <ghg:StandardofMeasureforCO2>Standard L</ghg:StandardofMeasureforCO2>
    <ghg:DensityofCO2 densityUOM="mton/scm">
      <ghg:MeasureValue>0.001868</ghg:MeasureValue>
    </ghg:DensityofCO2>
    <ghg:MethodofMeasureforCO2Density>rule required density</ghg:MethodofMeasureforCO2Density>
  </ghg:VolumeDetails>
  <ghg:VolumeDetails>
    <ghg:QuarterName>Second Quarter</ghg:QuarterName>
    <ghg:VolumetricFlowofCO2 volUOM="Standard Cubic Meters">
      <ghg:MeasureValue>1111200.8234</ghg:MeasureValue>
    </ghg:VolumetricFlowofCO2>
    <ghg:ConcentrationofCO2VolumePercent fractionUOM="fraction (number between 0 and 1)">
      <ghg:MeasureValue>0.206</ghg:MeasureValue>
    </ghg:ConcentrationofCO2VolumePercent>
    <ghg:StandardofMeasureforCO2>Standard L</ghg:StandardofMeasureforCO2>
    <ghg:DensityofCO2 densityUOM="mton/scm">
      <ghg:MeasureValue>0.001868</ghg:MeasureValue>
    </ghg:DensityofCO2>
    <ghg:MethodofMeasureforCO2Density>rule required density</ghg:MethodofMeasureforCO2Density>
  </ghg:VolumeDetails>
</ghg:VolumeDetails>

```



```

    <ghg:QuarterName>Third Quarter</ghg:QuarterName>
    <ghg:VolumetricFlowofCO2 volUOM="Standard Cubic Meters">
      <ghg:MeasureValue>1111300.234</ghg:MeasureValue>
    </ghg:VolumetricFlowofCO2>
    <ghg:ConcentrationofCO2VolumePercent fractionUOM="fraction (number between 0 and 1)">
      <ghg:MeasureValue>0.204</ghg:MeasureValue>
    </ghg:ConcentrationofCO2VolumePercent>
    <ghg:StandardofMeasureforCO2>Standard L</ghg:StandardofMeasureforCO2>
    <ghg:DensityofCO2 densityUOM="mton/scm">
      <ghg:MeasureValue>0.001868</ghg:MeasureValue>
    </ghg:DensityofCO2>
    <ghg:MethodofMeasureforCO2Density>rule required density</ghg:MethodofMeasureforCO2Density>
  </ghg:VolumeDetails>
</ghg:VolumeDetails>
  <ghg:QuarterName>Fourth Quarter</ghg:QuarterName>
  <ghg:VolumetricFlowofCO2 volUOM="Standard Cubic Meters">
    <ghg:MeasureValue>1111400.323</ghg:MeasureValue>
  </ghg:VolumetricFlowofCO2>
  <ghg:ConcentrationofCO2VolumePercent fractionUOM="fraction (number between 0 and 1)">
    <ghg:MeasureValue>0.306</ghg:MeasureValue>
  </ghg:ConcentrationofCO2VolumePercent>
  <ghg:StandardofMeasureforCO2>Standard L</ghg:StandardofMeasureforCO2>
  <ghg:DensityofCO2 densityUOM="mton/scm">
    <ghg:MeasureValue>0.001868</ghg:MeasureValue>
  </ghg:DensityofCO2>
  <ghg:MethodofMeasureforCO2Density>rule required density</ghg:MethodofMeasureforCO2Density>
</ghg:VolumeDetails>
</ghg:MeterDetails>
<ghg:MeterDetails>
  <ghg:UnitIdentification>
    <ghg:UnitName>001 - Mass FM</ghg:UnitName>
    <ghg:UnitDescription>Mass basis flow meter</ghg:UnitDescription>
    <ghg:UnitType>CO2 Flow Meter</ghg:UnitType>
  </ghg:UnitIdentification>
  <ghg:MassorVolume>Mass</ghg:MassorVolume>
  <ghg:AnnualMassofCO2 massUOM="Metric Tons">
    <ghg:MeasureValue>701.4</ghg:MeasureValue>
  </ghg:AnnualMassofCO2>
  <ghg:BiogenicStreamPercent>
    <ghg:MeasureValue>10</ghg:MeasureValue>
  </ghg:BiogenicStreamPercent>
  <ghg:FlowMeterEquipmentLocationDetails>
    <ghg:isDehydrationEquipmentUpStreamIndicator>Y</ghg:isDehydrationEquipmentUpStreamIndicator>
    <ghg:isDehydrationEquipmentDownStreamIndicator>Y</ghg:isDehydrationEquipmentDownStreamIndicator>
    <ghg:isCompressionEquipmentUpStreamIndicator>Y</ghg:isCompressionEquipmentUpStreamIndicator>
    <ghg:isCompressionEquipmentDownStreamIndicator>Y</ghg:isCompressionEquipmentDownStreamIndicator>
    <ghg:isOtherProcessingEquipmentUpStreamIndicator>Y</ghg:isOtherProcessingEquipmentUpStreamIndicator>
    <ghg:isOtherProcessingEquipmentDownStreamIndicator>Y</ghg:isOtherProcessingEquipmentDownStreamIndicator>
    <ghg:OtherProcessingEquipmentDescription>Processing equipment description</ghg:OtherProcessingEquipmentDescription>
  </ghg:FlowMeterEquipmentLocationDetails>
  <ghg:MassDetails>
    <ghg:QuarterName>First Quarter</ghg:QuarterName>
    <ghg:MassofCO2 massUOM="Metric Tons">
      <ghg:MeasureValue>100.923</ghg:MeasureValue>
    </ghg:MassofCO2>
  </ghg:MassDetails>

```

```

        <ghg:ConcentrationofCO2 fractionUOM="fraction (number between 0 and 1)">
          <ghg:MeasureValue>0.545</ghg:MeasureValue>
        </ghg:ConcentrationofCO2>
        <ghg:StandardofMeasureforCO2>Standard H</ghg:StandardofMeasureforCO2>
      </ghg:MassDetails>
    <ghg:MassDetails>
      <ghg:QuarterName>Second Quarter</ghg:QuarterName>
      <ghg:MassofCO2 massUOM="Metric Tons">
        <ghg:MeasureValue>200.824</ghg:MeasureValue>
      </ghg:MassofCO2>
      <ghg:ConcentrationofCO2 fractionUOM="fraction (number between 0 and 1)">
        <ghg:MeasureValue>0.6</ghg:MeasureValue>
      </ghg:ConcentrationofCO2>
      <ghg:StandardofMeasureforCO2>Standard H</ghg:StandardofMeasureforCO2>
    </ghg:MassDetails>
    <ghg:MassDetails>
      <ghg:QuarterName>Third Quarter</ghg:QuarterName>
      <ghg:MassofCO2 massUOM="Metric Tons">
        <ghg:MeasureValue>300.365</ghg:MeasureValue>
      </ghg:MassofCO2>
      <ghg:ConcentrationofCO2 fractionUOM="fraction (number between 0 and 1)">
        <ghg:MeasureValue>0.798</ghg:MeasureValue>
      </ghg:ConcentrationofCO2>
      <ghg:StandardofMeasureforCO2>Standard H</ghg:StandardofMeasureforCO2>
    </ghg:MassDetails>
    <ghg:MassDetails>
      <ghg:QuarterName>Fourth Quarter</ghg:QuarterName>
      <ghg:MassofCO2 massUOM="Metric Tons">
        <ghg:MeasureValue>400.2261</ghg:MeasureValue>
      </ghg:MassofCO2>
      <ghg:ConcentrationofCO2 fractionUOM="fraction (number between 0 and 1)">
        <ghg:MeasureValue>0.847</ghg:MeasureValue>
      </ghg:ConcentrationofCO2>
      <ghg:StandardofMeasureforCO2>Standard H</ghg:StandardofMeasureforCO2>
    </ghg:MassDetails>
  </ghg:MeterDetails>
<ghg:MeterDetails>
  <ghg:UnitIdentification>
    <ghg:UnitName>002- Vol Wt FM</ghg:UnitName>
    <ghg:UnitDescription>Volumetric basis (concentration in weight percentage) flow meter</ghg:UnitDescription>
    <ghg:UnitType>CO2 Flow Meter</ghg:UnitType>
  </ghg:UnitIdentification>
  <ghg:MassorVolume>Volumetric - concentration in weight percentage</ghg:MassorVolume>
  <ghg:AnnualMassofCO2 massUOM="Metric Tons">
    <ghg:MeasureValue>28.8</ghg:MeasureValue>
  </ghg:AnnualMassofCO2>
  <ghg:BiogenicStreamPercent>
    <ghg:MeasureValue>20.254</ghg:MeasureValue>
  </ghg:BiogenicStreamPercent>
  <ghg:FlowMeterEquipmentLocationDetails>
    <ghg:isDehydrationEquipmentUpStreamIndicator>N</ghg:isDehydrationEquipmentUpStreamIndicator>
    <ghg:isDehydrationEquipmentDownStreamIndicator>N</ghg:isDehydrationEquipmentDownStreamIndicator>
    <ghg:isCompressionEquipmentUpStreamIndicator>N</ghg:isCompressionEquipmentUpStreamIndicator>
    <ghg:isCompressionEquipmentDownStreamIndicator>N</ghg:isCompressionEquipmentDownStreamIndicator>
  </ghg:FlowMeterEquipmentLocationDetails>

```

```

    <ghg:isOtherProcessingEquipmentUpStreamIndicator>N</ghg:isOtherProcessingEquipmentUpStreamIndicator>
    <ghg:isOtherProcessingEquipmentDownStreamIndicator>N</ghg:isOtherProcessingEquipmentDownStreamIndicator>
    <ghg:OtherProcessingEquipmentDescription>Processing equipment description I</ghg:OtherProcessingEquipmentDescription>
  </ghg:FlowMeterEquipmentLocationDetails>
  <ghg:VolumeDetails>
    <ghg:QuarterName>First Quarter</ghg:QuarterName>
    <ghg:VolumetricFlowofCO2 volUOM="Standard Cubic Meters">
      <ghg:MeasureValue>10.7234</ghg:MeasureValue>
    </ghg:VolumetricFlowofCO2>
    <ghg:ConcentrationofCO2WeightPercent fractionUOM="fraction (number between 0 and 1)">
      <ghg:MeasureValue>0.117</ghg:MeasureValue>
    </ghg:ConcentrationofCO2WeightPercent>
    <ghg:StandardofMeasureforCO2>Standard K</ghg:StandardofMeasureforCO2>
    <ghg:DensityofCO2 densityUOM="mton/scm">
      <ghg:MeasureValue>0.50252</ghg:MeasureValue>
    </ghg:DensityofCO2>
    <ghg:MethodofMeasureforCO2Density>Standard J</ghg:MethodofMeasureforCO2Density>
  </ghg:VolumeDetails>
  <ghg:VolumeDetails>
    <ghg:QuarterName>Second Quarter</ghg:QuarterName>
    <ghg:VolumetricFlowofCO2 volUOM="Standard Cubic Meters">
      <ghg:MeasureValue>20.8</ghg:MeasureValue>
    </ghg:VolumetricFlowofCO2>
    <ghg:ConcentrationofCO2WeightPercent fractionUOM="fraction (number between 0 and 1)">
      <ghg:MeasureValue>0.22</ghg:MeasureValue>
    </ghg:ConcentrationofCO2WeightPercent>
    <ghg:StandardofMeasureforCO2>Standard K</ghg:StandardofMeasureforCO2>
    <ghg:DensityofCO2 densityUOM="mton/scm">
      <ghg:MeasureValue>0.6034</ghg:MeasureValue>
    </ghg:DensityofCO2>
    <ghg:MethodofMeasureforCO2Density>Standard J</ghg:MethodofMeasureforCO2Density>
  </ghg:VolumeDetails>
  <ghg:VolumeDetails>
    <ghg:QuarterName>Third Quarter</ghg:QuarterName>
    <ghg:VolumetricFlowofCO2 volUOM="Standard Cubic Meters">
      <ghg:MeasureValue>30.6112</ghg:MeasureValue>
    </ghg:VolumetricFlowofCO2>
    <ghg:ConcentrationofCO2WeightPercent fractionUOM="fraction (number between 0 and 1)">
      <ghg:MeasureValue>0.331</ghg:MeasureValue>
    </ghg:ConcentrationofCO2WeightPercent>
    <ghg:StandardofMeasureforCO2>Standard K</ghg:StandardofMeasureforCO2>
    <ghg:DensityofCO2 densityUOM="mton/scm">
      <ghg:MeasureValue>0.7025</ghg:MeasureValue>
    </ghg:DensityofCO2>
    <ghg:MethodofMeasureforCO2Density>Standard J</ghg:MethodofMeasureforCO2Density>
  </ghg:VolumeDetails>
  <ghg:VolumeDetails>
    <ghg:QuarterName>Fourth Quarter</ghg:QuarterName>
    <ghg:VolumetricFlowofCO2 volUOM="Standard Cubic Meters">
      <ghg:MeasureValue>40.5789</ghg:MeasureValue>
    </ghg:VolumetricFlowofCO2>
    <ghg:ConcentrationofCO2WeightPercent fractionUOM="fraction (number between 0 and 1)">
      <ghg:MeasureValue>0.445</ghg:MeasureValue>
    </ghg:ConcentrationofCO2WeightPercent>
    <ghg:StandardofMeasureforCO2>Standard K</ghg:StandardofMeasureforCO2>
  </ghg:VolumeDetails>

```

```

        <ghg:DensityofCO2 densityUOM="mton/scm">
          <ghg:MeasureValue>0.8091</ghg:MeasureValue>
        </ghg:DensityofCO2>
        <ghg:MethodofMeasureforCO2Density>Standard J</ghg:MethodofMeasureforCO2Density>
      </ghg:VolumeDetails>
    </ghg:MeterDetails>
  <ghg:CO2EndUseDetails>
    <ghg:ApplicationName>Food and beverage</ghg:ApplicationName>
    <ghg:ImportExport>All</ghg:ImportExport>
    <ghg:QuantityofCO2 massUOM="Metric Tons">
      <ghg:MeasureValue>100.1234</ghg:MeasureValue>
    </ghg:QuantityofCO2>
  </ghg:CO2EndUseDetails>
  <ghg:CO2EndUseDetails>
    <ghg:ApplicationName>Industrial and municipal water/wastewater treatment</ghg:ApplicationName>
    <ghg:ImportExport>All</ghg:ImportExport>
    <ghg:QuantityofCO2 massUOM="Metric Tons">
      <ghg:MeasureValue>200.2347</ghg:MeasureValue>
    </ghg:QuantityofCO2>
  </ghg:CO2EndUseDetails>
  <ghg:CO2EndUseDetails>
    <ghg:ApplicationName>Metal fabrication, including welding and cutting</ghg:ApplicationName>
    <ghg:ImportExport>All</ghg:ImportExport>
    <ghg:QuantityofCO2 massUOM="Metric Tons">
      <ghg:MeasureValue>300.523657</ghg:MeasureValue>
    </ghg:QuantityofCO2>
  </ghg:CO2EndUseDetails>
  <ghg:CO2EndUseDetails>
    <ghg:ApplicationName>Greenhouse uses for plant growth</ghg:ApplicationName>
    <ghg:ImportExport>All</ghg:ImportExport>
    <ghg:QuantityofCO2 massUOM="Metric Tons">
      <ghg:MeasureValue>400.8314</ghg:MeasureValue>
    </ghg:QuantityofCO2>
  </ghg:CO2EndUseDetails>
  <ghg:CO2EndUseDetails>
    <ghg:ApplicationName>Fumigants (e.g., grain storage) and herbicides</ghg:ApplicationName>
    <ghg:ImportExport>All</ghg:ImportExport>
    <ghg:QuantityofCO2 massUOM="Metric Tons">
      <ghg:MeasureValue>500.59878</ghg:MeasureValue>
    </ghg:QuantityofCO2>
  </ghg:CO2EndUseDetails>
  <ghg:CO2EndUseDetails>
    <ghg:ApplicationName>Pulp and paper</ghg:ApplicationName>
    <ghg:ImportExport>All</ghg:ImportExport>
    <ghg:QuantityofCO2 massUOM="Metric Tons">
      <ghg:MeasureValue>600.83434</ghg:MeasureValue>
    </ghg:QuantityofCO2>
  </ghg:CO2EndUseDetails>
  <ghg:CO2EndUseDetails>
    <ghg:ApplicationName>Cleaning and solvent use</ghg:ApplicationName>
    <ghg:ImportExport>All</ghg:ImportExport>
    <ghg:QuantityofCO2 massUOM="Metric Tons">
      <ghg:MeasureValue>700.62</ghg:MeasureValue>
    </ghg:QuantityofCO2>
  </ghg:CO2EndUseDetails>

```

```

<ghg:CO2EndUseDetails>
  <ghg:ApplicationName>Fire fighting</ghg:ApplicationName>
  <ghg:ImportExport>All</ghg:ImportExport>
  <ghg:QuantityofCO2 massUOM="Metric Tons">
    <ghg:MeasureValue>80.3</ghg:MeasureValue>
  </ghg:QuantityofCO2>
</ghg:CO2EndUseDetails>
<ghg:CO2EndUseDetails>
  <ghg:ApplicationName>Transportation and storage of explosives</ghg:ApplicationName>
  <ghg:ImportExport>All</ghg:ImportExport>
  <ghg:QuantityofCO2 massUOM="Metric Tons">
    <ghg:MeasureValue>900.236</ghg:MeasureValue>
  </ghg:QuantityofCO2>
</ghg:CO2EndUseDetails>
<ghg:CO2EndUseDetails>
  <ghg:ApplicationName>Injection of CO2 for enhanced oil and natural gas recovery that is covered by 40 CFR Part 98, Subpart
  UU</ghg:ApplicationName>
  <ghg:ImportExport>All</ghg:ImportExport>
  <ghg:QuantityofCO2 massUOM="Metric Tons">
    <ghg:MeasureValue>1000.2233</ghg:MeasureValue>
  </ghg:QuantityofCO2>
</ghg:CO2EndUseDetails>
<ghg:CO2EndUseDetails>
  <ghg:ApplicationName>Geologic sequestration of carbon dioxide that is covered by 40 CFR Part 98, Subpart RR</ghg:ApplicationName>
  <ghg:ImportExport>All</ghg:ImportExport>
  <ghg:QuantityofCO2 massUOM="Metric Tons">
    <ghg:MeasureValue>1100.3123</ghg:MeasureValue>
  </ghg:QuantityofCO2>
</ghg:CO2EndUseDetails>
<ghg:CO2EndUseDetails>
  <ghg:ApplicationName>Research and Development</ghg:ApplicationName>
  <ghg:ImportExport>All</ghg:ImportExport>
  <ghg:QuantityofCO2 massUOM="Metric Tons">
    <ghg:MeasureValue>1200.3987</ghg:MeasureValue>
  </ghg:QuantityofCO2>
</ghg:CO2EndUseDetails>
<ghg:CO2EndUseDetails>
  <ghg:ApplicationName>Other</ghg:ApplicationName>
  <ghg:OtherApplicationName>Test Description</ghg:OtherApplicationName>
  <ghg:ImportExport>All</ghg:ImportExport>
  <ghg:QuantityofCO2 massUOM="Metric Tons">
    <ghg:MeasureValue>1300.3</ghg:MeasureValue>
  </ghg:QuantityofCO2>
</ghg:CO2EndUseDetails>
<ghg:CO2EndUseDetails>
  <ghg:ApplicationName>Unknown</ghg:ApplicationName>
  <ghg:ImportExport>All</ghg:ImportExport>
  <ghg:QuantityofCO2 massUOM="Metric Tons">
    <ghg:MeasureValue>1400.2</ghg:MeasureValue>
  </ghg:QuantityofCO2>
</ghg:CO2EndUseDetails>
<ghg:EquipmentCalibrationDetails>
  <ghg:MeasuringEquipmentType>Mass flow meter</ghg:MeasuringEquipmentType>
  <ghg:StandardForCalibration>Standard A</ghg:StandardForCalibration>
</ghg:EquipmentCalibrationDetails>

```

```

    <ghg:EquipmentCalibrationDetails>
      <ghg:MeasuringEquipmentType>Volumetric flow meter</ghg:MeasuringEquipmentType>
      <ghg:StandardForCalibration>Standard B</ghg:StandardForCalibration>
    </ghg:EquipmentCalibrationDetails>
    <ghg:EquipmentCalibrationDetails>
      <ghg:MeasuringEquipmentType>Scale</ghg:MeasuringEquipmentType>
      <ghg:StandardForCalibration>Standard C</ghg:StandardForCalibration>
    </ghg:EquipmentCalibrationDetails>
    <ghg:EquipmentCalibrationDetails>
      <ghg:MeasuringEquipmentType>Load cell</ghg:MeasuringEquipmentType>
      <ghg:StandardForCalibration>Standard D</ghg:StandardForCalibration>
    </ghg:EquipmentCalibrationDetails>
    <ghg:EquipmentCalibrationDetails>
      <ghg:MeasuringEquipmentType>Weigh bill</ghg:MeasuringEquipmentType>
      <ghg:StandardForCalibration>Standard E</ghg:StandardForCalibration>
    </ghg:EquipmentCalibrationDetails>
    <ghg:EquipmentCalibrationDetails>
      <ghg:MeasuringEquipmentType>Loaded container volume</ghg:MeasuringEquipmentType>
      <ghg:StandardForCalibration>Standard F</ghg:StandardForCalibration>
    </ghg:EquipmentCalibrationDetails>
    <ghg:EquipmentCalibrationDetails>
      <ghg:MeasuringEquipmentType>Other</ghg:MeasuringEquipmentType>
      <ghg:StandardForCalibration>Standard G</ghg:StandardForCalibration>
    </ghg:EquipmentCalibrationDetails>
    <ghg:MassVolumeNumberofDaysSubstituted>1</ghg:MassVolumeNumberofDaysSubstituted>
    <ghg:ConcentrationNumberofDaysSubstituted>2</ghg:ConcentrationNumberofDaysSubstituted>
    <ghg:DensityNumberofDaysSubstituted>3</ghg:DensityNumberofDaysSubstituted>
  </ghg:SubPartPP>
</ghg:SubPartInformation>
</ghg:FacilitySiteDetails>
<ghg:CalculationMethodologyChangesDescription>None</ghg:CalculationMethodologyChangesDescription>
<ghg:BestAvailableMonitoringMethodsUsed>N/A</ghg:BestAvailableMonitoringMethodsUsed>
<ghg:StartDate>2019-01-01</ghg:StartDate>
<ghg:EndDate>2019-12-31</ghg:EndDate>
<ghg:DateTimeReportGenerated>2019-02-24T10:16:31</ghg:DateTimeReportGenerated>
</ghg:FacilitySiteInformation>
</ghg:GHG>

```

## 2.0 Capture Facility – Flow Meters 2

### [98.423(a)(3)(ii)]

*(Note: Data values do not reflect an actual facility's emissions. Additional sample XML files for Subpart PP are posted on the e-GGRT help site.)*

```

<ghg:GHG xmlns="http://www.ccdsupport.com/schema/ghg">
  <ghg:FacilitySiteInformation>
    <ghg:CertificationStatement>The designated representative or alternate designated representative must sign (i.e., agree to) this certification statement. If you are an agent and you click on "SUBMIT", you are not agreeing to the certification statement, but are submitting the certification statement on behalf of the designated representative or alternate designated representative who is agreeing to the certification statement. An agent is only authorized to make the electronic submission on behalf of the designated representative, not to sign (i.e., agree to) the certification statement. </ghg:CertificationStatement>
    <ghg:ReportingYear>2019</ghg:ReportingYear>
    <ghg:FacilitySiteDetails>
      <ghg:FacilitySite>
        <ghg:FacilitySiteIdentifier>524117</ghg:FacilitySiteIdentifier>
        <ghg:FacilitySiteName>Capture- Flow Meters 2 TEST Facility</ghg:FacilitySiteName>
      </ghg:FacilitySite>
      <ghg:LocationAddress>
        <ghg:LocationAddressText>12600 S. ANY STREET</ghg:LocationAddressText>
        <ghg:LocalityName>CHICAGO</ghg:LocalityName>
        <ghg:StateIdentity>
          <ghg:StateCode>IL</ghg:StateCode>
        </ghg:StateIdentity>
        <ghg:AddressPostalCode>60633</ghg:AddressPostalCode>
      </ghg:LocationAddress>
      <ghg:CogenerationUnitEmissionsIndicator>N</ghg:CogenerationUnitEmissionsIndicator>
      <ghg:PrimaryNAICSCode>325120</ghg:PrimaryNAICSCode>
      <ghg:ParentCompanyDetails>
        <ghg:ParentCompany>
          <ghg:ParentCompanyLegalName>Soda Ash Corporation</ghg:ParentCompanyLegalName>
          <ghg:StreetAddress>108 Hillcrest Street</ghg:StreetAddress>
          <ghg:City>Sandpoint</ghg:City>
          <ghg:State>ID</ghg:State>
          <ghg:Zip>83864</ghg:Zip>
          <ghg:PercentOwnershipInterest>100.0</ghg:PercentOwnershipInterest>
        </ghg:ParentCompany>
      </ghg:ParentCompanyDetails>
      <ghg>TotalNonBiogenicCO2eFacilitySubpartsCtoJJ massUOM="Metric Tons">0</ghg>TotalNonBiogenicCO2eFacilitySubpartsCtoJJ>
      <ghg>TotalBiogenicCO2FacilitySubpartsCtoJJ massUOM="Metric Tons">0</ghg>TotalBiogenicCO2FacilitySubpartsCtoJJ>
      <ghg>TotalCO2eSupplierSubpartsKktoPP massUOM="Metric Tons">700.5</ghg>TotalCO2eSupplierSubpartsKktoPP>
    </ghg:SubPartInformation>
    <ghg:SubPartPP>
      <ghg:GHGasInfoDetails>
        <ghg:GHGasName>Carbon Dioxide</ghg:GHGasName>
        <ghg:GHGasQuantity massUOM="Metric Tons">
          <ghg:CalculatedValue>700.5</ghg:CalculatedValue>
        </ghg:GHGasQuantity>
      </ghg:GHGasInfoDetails>
      <ghg:FacilityClassification>capture 98.420(a)(1)</ghg:FacilityClassification>
      <ghg:CalculationMethodology>Flow Meters 2</ghg:CalculationMethodology>
    </ghg:SubPartPP>
  </ghg:FacilitySiteInformation>
</ghg:GHG>

```

```

<ghg:MeterDetails>
  <ghg:UnitIdentification>
    <ghg:UnitName>001- Mass FM</ghg:UnitName>
    <ghg:UnitDescription>Mass basis flow meter</ghg:UnitDescription>
    <ghg:UnitType>CO2 Flow Meter</ghg:UnitType>
  </ghg:UnitIdentification>
  <ghg:MassorVolume>Mass</ghg:MassorVolume>
  <ghg:AnnualMassofCO2 massUOM="Metric Tons">
    <ghg:MeasureValue>700.3</ghg:MeasureValue>
  </ghg:AnnualMassofCO2>
  <ghg:MeterSegregationLocation>UpStream</ghg:MeterSegregationLocation>
  <ghg:MeterImportExport>NA</ghg:MeterImportExport>
  <ghg:BiogenicStreamPercent>
    <ghg:MeasureValue>10.865</ghg:MeasureValue>
  </ghg:BiogenicStreamPercent>
  <ghg:FlowMeterEquipmentLocationDetails>
    <ghg:isDehydrationEquipmentUpStreamIndicator>Y</ghg:isDehydrationEquipmentUpStreamIndicator>
    <ghg:isDehydrationEquipmentDownStreamIndicator>Y</ghg:isDehydrationEquipmentDownStreamIndicator>
    <ghg:isCompressionEquipmentUpStreamIndicator>Y</ghg:isCompressionEquipmentUpStreamIndicator>
    <ghg:isCompressionEquipmentDownStreamIndicator>Y</ghg:isCompressionEquipmentDownStreamIndicator>
    <ghg:isOtherProcessingEquipmentUpStreamIndicator>Y</ghg:isOtherProcessingEquipmentUpStreamIndicator>
    <ghg:isOtherProcessingEquipmentDownStreamIndicator>Y</ghg:isOtherProcessingEquipmentDownStreamIndicator>
    <ghg:OtherProcessingEquipmentDescription>Processing equipment description</ghg:OtherProcessingEquipmentDescription>
  </ghg:FlowMeterEquipmentLocationDetails>
  <ghg:MassDetails>
    <ghg:QuarterName>First Quarter</ghg:QuarterName>
    <ghg:MassofCO2 massUOM="Metric Tons">
      <ghg:MeasureValue>100.254</ghg:MeasureValue>
    </ghg:MassofCO2>
    <ghg:ConcentrationofCO2 fractionUOM="fraction (number between 0 and 1)">
      <ghg:MeasureValue>0.584</ghg:MeasureValue>
    </ghg:ConcentrationofCO2>
    <ghg:StandardofMeasureforCO2>Standard H</ghg:StandardofMeasureforCO2>
  </ghg:MassDetails>
  <ghg:MassDetails>
    <ghg:QuarterName>Second Quarter</ghg:QuarterName>
    <ghg:MassofCO2 massUOM="Metric Tons">
      <ghg:MeasureValue>200.456</ghg:MeasureValue>
    </ghg:MassofCO2>
    <ghg:ConcentrationofCO2 fractionUOM="fraction (number between 0 and 1)">
      <ghg:MeasureValue>0.665</ghg:MeasureValue>
    </ghg:ConcentrationofCO2>
    <ghg:StandardofMeasureforCO2>Standard H</ghg:StandardofMeasureforCO2>
  </ghg:MassDetails>
  <ghg:MassDetails>
    <ghg:QuarterName>Third Quarter</ghg:QuarterName>
    <ghg:MassofCO2 massUOM="Metric Tons">
      <ghg:MeasureValue>300.3423</ghg:MeasureValue>
    </ghg:MassofCO2>
    <ghg:ConcentrationofCO2 fractionUOM="fraction (number between 0 and 1)">
      <ghg:MeasureValue>0.787</ghg:MeasureValue>
    </ghg:ConcentrationofCO2>
    <ghg:StandardofMeasureforCO2>Standard H</ghg:StandardofMeasureforCO2>
  </ghg:MassDetails>
</ghg:MassDetails>

```



```

    <ghg:QuarterName>Fourth Quarter</ghg:QuarterName>
    <ghg:MassofCO2 massUOM="Metric Tons">
      <ghg:MeasureValue>400.3567</ghg:MeasureValue>
    </ghg:MassofCO2>
    <ghg:ConcentrationofCO2 fractionUOM="fraction (number between 0 and 1)">
      <ghg:MeasureValue>0.885</ghg:MeasureValue>
    </ghg:ConcentrationofCO2>
    <ghg:StandardofMeasureforCO2>Standard H</ghg:StandardofMeasureforCO2>
  </ghg:MeterDetails>
</ghg:MeterDetails>
<ghg:CO2EndUseDetails>
  <ghg:ApplicationName>Food and beverage</ghg:ApplicationName>
  <ghg:ImportExport>All</ghg:ImportExport>
  <ghg:QuantityofCO2 massUOM="Metric Tons">
    <ghg:MeasureValue>100.11211</ghg:MeasureValue>
  </ghg:QuantityofCO2>
</ghg:CO2EndUseDetails>
<ghg:CO2EndUseDetails>
  <ghg:ApplicationName>Industrial and municipal water/wastewater treatment</ghg:ApplicationName>
  <ghg:ImportExport>All</ghg:ImportExport>
  <ghg:QuantityofCO2 massUOM="Metric Tons">
    <ghg:MeasureValue>200.11111</ghg:MeasureValue>
  </ghg:QuantityofCO2>
</ghg:CO2EndUseDetails>
<ghg:CO2EndUseDetails>
  <ghg:ApplicationName>Metal fabrication, including welding and cutting</ghg:ApplicationName>
  <ghg:ImportExport>All</ghg:ImportExport>
  <ghg:QuantityofCO2 massUOM="Metric Tons">
    <ghg:MeasureValue>300.11131</ghg:MeasureValue>
  </ghg:QuantityofCO2>
</ghg:CO2EndUseDetails>
<ghg:CO2EndUseDetails>
  <ghg:ApplicationName>Greenhouse uses for plant growth</ghg:ApplicationName>
  <ghg:ImportExport>All</ghg:ImportExport>
  <ghg:QuantityofCO2 massUOM="Metric Tons">
    <ghg:MeasureValue>400.11111</ghg:MeasureValue>
  </ghg:QuantityofCO2>
</ghg:CO2EndUseDetails>
<ghg:CO2EndUseDetails>
  <ghg:ApplicationName>Fumigants (e.g., grain storage) and herbicides</ghg:ApplicationName>
  <ghg:ImportExport>All</ghg:ImportExport>
  <ghg:QuantityofCO2 massUOM="Metric Tons">
    <ghg:MeasureValue>500.11111</ghg:MeasureValue>
  </ghg:QuantityofCO2>
</ghg:CO2EndUseDetails>
<ghg:CO2EndUseDetails>
  <ghg:ApplicationName>Pulp and paper</ghg:ApplicationName>
  <ghg:ImportExport>All</ghg:ImportExport>
  <ghg:QuantityofCO2 massUOM="Metric Tons">
    <ghg:MeasureValue>600.11111</ghg:MeasureValue>
  </ghg:QuantityofCO2>
</ghg:CO2EndUseDetails>
<ghg:CO2EndUseDetails>
  <ghg:ApplicationName>Cleaning and solvent use</ghg:ApplicationName>
  <ghg:ImportExport>All</ghg:ImportExport>

```

```

    <ghg:QuantityofCO2massUOM="Metric Tons">
      <ghg:MeasureValue>700.11111</ghg:MeasureValue>
    </ghg:QuantityofCO2>
  </ghg:CO2EndUseDetails>
  <ghg:CO2EndUseDetails>
    <ghg:ApplicationName>Fire fighting</ghg:ApplicationName>
    <ghg:ImportExport>All</ghg:ImportExport>
    <ghg:QuantityofCO2massUOM="Metric Tons">
      <ghg:MeasureValue>800.11111</ghg:MeasureValue>
    </ghg:QuantityofCO2>
  </ghg:CO2EndUseDetails>
  <ghg:CO2EndUseDetails>
    <ghg:ApplicationName>Transportation and storage of explosives</ghg:ApplicationName>
    <ghg:ImportExport>All</ghg:ImportExport>
    <ghg:QuantityofCO2massUOM="Metric Tons">
      <ghg:MeasureValue>900.11111</ghg:MeasureValue>
    </ghg:QuantityofCO2>
  </ghg:CO2EndUseDetails>
  <ghg:CO2EndUseDetails>
    <ghg:ApplicationName>Injection of CO2 for enhanced oil and natural gas recovery that is covered by 40 CFR Part 98, Subpart UU
    </ghg:ApplicationName>
    <ghg:ImportExport>All</ghg:ImportExport>
    <ghg:QuantityofCO2massUOM="Metric Tons">
      <ghg:MeasureValue>1000.11111</ghg:MeasureValue>
    </ghg:QuantityofCO2>
  </ghg:CO2EndUseDetails>
  <ghg:CO2EndUseDetails>
    <ghg:ApplicationName>Geologic sequestration of carbon dioxide that is covered by 40 CFR Part 98, Subpart RR</ghg:ApplicationName>
    <ghg:ImportExport>All</ghg:ImportExport>
    <ghg:QuantityofCO2massUOM="Metric Tons">
      <ghg:MeasureValue>1100.11111</ghg:MeasureValue>
    </ghg:QuantityofCO2>
  </ghg:CO2EndUseDetails>
  <ghg:CO2EndUseDetails>
    <ghg:ApplicationName>Research and Development</ghg:ApplicationName>
    <ghg:ImportExport>All</ghg:ImportExport>
    <ghg:QuantityofCO2massUOM="Metric Tons">
      <ghg:MeasureValue>1200.11111</ghg:MeasureValue>
    </ghg:QuantityofCO2>
  </ghg:CO2EndUseDetails>
  <ghg:CO2EndUseDetails>
    <ghg:ApplicationName>Other</ghg:ApplicationName>
    <ghg:OtherApplicationName>Test Description</ghg:OtherApplicationName>
    <ghg:ImportExport>All</ghg:ImportExport>
    <ghg:QuantityofCO2massUOM="Metric Tons">
      <ghg:MeasureValue>1300.11111</ghg:MeasureValue>
    </ghg:QuantityofCO2>
  </ghg:CO2EndUseDetails>
  <ghg:EquipmentCalibrationDetails>
    <ghg:MeasuringEquipmentType>Mass flow meter</ghg:MeasuringEquipmentType>
    <ghg:StandardForCalibration>Standard A</ghg:StandardForCalibration>
  </ghg:EquipmentCalibrationDetails>
  <ghg:ElectricityGeneratingUnitsWithCapturedCo2StreamsDetails>
    <ghg:Ghgrpid>515109</ghg:Ghgrpid>
    <ghg:FacilityName>Chubnell Basket</ghg:FacilityName>
  </ghg:ElectricityGeneratingUnitsWithCapturedCo2StreamsDetails>

```

```
</ghg:ElectricityGeneratingUnitsWithCapturedCo2StreamsDetails>
<ghg:RRFacilitiesWhereCo2TransferredToDetails>
  <ghg:Ghgrpid>515108</ghg:Ghgrpid>
  <ghg:FacilityName>Chubnell Basket 2</ghg:FacilityName>
  <ghg:CO2Quantity massUOM="Metric Tons">
    <ghg:MeasureValue>1000</ghg:MeasureValue>
  </ghg:CO2Quantity>
</ghg:RRFacilitiesWhereCo2TransferredToDetails>
<ghg:MassVolumeNumberofDaysSubstituted>1</ghg:MassVolumeNumberofDaysSubstituted>
<ghg:ConcentrationNumberofDaysSubstituted>2</ghg:ConcentrationNumberofDaysSubstituted>
<ghg:DensityNumberofDaysSubstituted>3</ghg:DensityNumberofDaysSubstituted>
</ghg:SubPartPP>
</ghg:SubPartInformation>
</ghg:FacilitySiteDetails>
<ghg:CalculationMethodologyChangesDescription/>
<ghg:BestAvailableMonitoringMethodsUsed/>
<ghg:StartDate>2013-01-01</ghg:StartDate>
<ghg:EndDate>2013-12-31</ghg:EndDate>
<ghg:DateTimeReportGenerated>2014-02-24T10:16:31</ghg:DateTimeReportGenerated>
</ghg:FacilitySiteInformation>
</ghg:GHG>
```

### 3.0 Capture Facility – Streams with Subpart D and RR Facilities

#### [98.423(b)]

*(Note: Schema applied to RY2016 and later reporting years. Data values do not reflect an actual facility's emissions. Additional sample XML files for Subpart PP are posted on the e-GGRT help site.)*

```

<ghg:GHG xmlns="http://www.ccdsupport.com/schema/ghg">
  <ghg:FacilitySiteInformation>
    <ghg:CertificationStatement>The designated representative or alternate designated representative must sign (i.e., agree to) this certification statement. If you are an agent and you click on "SUBMIT", you are not agreeing to the certification statement, but are submitting the certification statement on behalf of the designated representative or alternate designated representative who is agreeing to the certification statement. An agent is only authorized to make the electronic submission on behalf of the designated representative, not to sign (i.e., agree to) the certification statement.</ghg:CertificationStatement>
    <ghg:ReportingYear>2013</ghg:ReportingYear>
    <ghg:FacilitySiteDetails>
      <ghg:FacilitySite>
        <ghg:FacilitySiteIdentifier>524117</ghg:FacilitySiteIdentifier>
        <ghg:FacilitySiteName>Capture- Streams TEST Facility</ghg:FacilitySiteName>
      </ghg:FacilitySite>
      <ghg:LocationAddress>
        <ghg:LocationAddressText>12600 S. ANY STREET</ghg:LocationAddressText>
        <ghg:LocalityName>CHICAGO</ghg:LocalityName>
        <ghg:StateIdentity>
          <ghg:StateCode>IL</ghg:StateCode>
        </ghg:StateIdentity>
        <ghg:AddressPostalCode>60633</ghg:AddressPostalCode>
      </ghg:LocationAddress>
      <ghg:CogenerationUnitEmissionsIndicator>N</ghg:CogenerationUnitEmissionsIndicator>
      <ghg:PrimaryNAICSCode>325120</ghg:PrimaryNAICSCode>
      <ghg:ParentCompanyDetails>
        <ghg:ParentCompany>
          <ghg:ParentCompanyLegalName>Soda Ash Corporation</ghg:ParentCompanyLegalName>
          <ghg:StreetAddress>108 Hillcrest Street</ghg:StreetAddress>
          <ghg:City>Sandpoint</ghg:City>
          <ghg:State>ID</ghg:State>
          <ghg:Zip>83864</ghg:Zip>
          <ghg:PercentOwnershipInterest>100.0</ghg:PercentOwnershipInterest>
        </ghg:ParentCompany>
      </ghg:ParentCompanyDetails>
      <ghg:TotalNonBiogenicCO2eFacilitySubpartsCtoJJ massUOM="Metric Tons">0</ghg:TotalNonBiogenicCO2eFacilitySubpartsCtoJJ>
      <ghg:TotalBiogenicCO2FacilitySubpartsCtoJJ massUOM="Metric Tons">0</ghg:TotalBiogenicCO2FacilitySubpartsCtoJJ>
      <ghg:TotalCO2eSupplierSubpartsKktoPP massUOM="Metric Tons">2200000.3</ghg:TotalCO2eSupplierSubpartsKktoPP>
      <ghg:SubPartInformation>
        <ghg:SubPartPP>
          <ghg:GHGasInfoDetails>
            <ghg:GHGasName>Carbon Dioxide</ghg:GHGasName>
            <ghg:GHGasQuantity massUOM="Metric Tons">
              <ghg:CalculatedValue>2200000.3</ghg:CalculatedValue>
            </ghg:GHGasQuantity>
          </ghg:GHGasInfoDetails>
          <ghg:FacilityClassification>capture 98.420(a)(1)</ghg:FacilityClassification>
          <ghg:CalculationMethodology>Streams</ghg:CalculationMethodology>
        </ghg:SubPartPP>
      </ghg:SubPartInformation>
    </ghg:FacilitySiteDetails>
  </ghg:FacilitySiteInformation>
</ghg:GHG>

```

```

<ghg:MeterDetails>
  <ghg:UnitIdentification>
    <ghg:UnitName>001- CO2 Stream </ghg:UnitName>
    <ghg:UnitDescription>CO2 stream #1 </ghg:UnitDescription>
    <ghg:UnitType>CO2 Stream </ghg:UnitType>
  </ghg:UnitIdentification>
  <ghg:MassorVolume>Volumetric - concentration in weight percentage</ghg:MassorVolume>
  <ghg:AnnualMassofCO2 massUOM="Metric Tons">
    <ghg:MeasureValue>220000.3</ghg:MeasureValue>
  </ghg:AnnualMassofCO2>
  <ghg:VolumeDetails>
    <ghg:QuarterName>First Quarter</ghg:QuarterName>
    <ghg:VolumetricFlowofCO2 volUOM="Standard Cubic Meters">
      <ghg:MeasureValue>10000.34535</ghg:MeasureValue>
    </ghg:VolumetricFlowofCO2>
    <ghg:ConcentrationofCO2WeightPercent fractionUOM="fraction (number between 0 and 1)">
      <ghg:MeasureValue>0.5</ghg:MeasureValue>
    </ghg:ConcentrationofCO2WeightPercent>
    <ghg:StandardofMeasureforCO2>Standard K</ghg:StandardofMeasureforCO2>
    <ghg:DensityofCO2 densityUOM="mton/scm">
      <ghg:MeasureValue>10.325</ghg:MeasureValue>
    </ghg:DensityofCO2>
    <ghg:MethodofMeasureforCO2Density>Standard J</ghg:MethodofMeasureforCO2Density>
  </ghg:VolumeDetails>
  <ghg:VolumeDetails>
    <ghg:QuarterName>Second Quarter</ghg:QuarterName>
    <ghg:VolumetricFlowofCO2 volUOM="Standard Cubic Meters">
      <ghg:MeasureValue>20000.1</ghg:MeasureValue>
    </ghg:VolumetricFlowofCO2>
    <ghg:ConcentrationofCO2WeightPercent fractionUOM="fraction (number between 0 and 1)">
      <ghg:MeasureValue>0.647</ghg:MeasureValue>
    </ghg:ConcentrationofCO2WeightPercent>
    <ghg:StandardofMeasureforCO2>Standard K</ghg:StandardofMeasureforCO2>
    <ghg:DensityofCO2 densityUOM="mton/scm">
      <ghg:MeasureValue>20.25</ghg:MeasureValue>
    </ghg:DensityofCO2>
    <ghg:MethodofMeasureforCO2Density>Standard J</ghg:MethodofMeasureforCO2Density>
  </ghg:VolumeDetails>
  <ghg:VolumeDetails>
    <ghg:QuarterName>Third Quarter</ghg:QuarterName>
    <ghg:VolumetricFlowofCO2 volUOM="Standard Cubic Meters">
      <ghg:MeasureValue>30000.23</ghg:MeasureValue>
    </ghg:VolumetricFlowofCO2>
    <ghg:ConcentrationofCO2WeightPercent fractionUOM="fraction (number between 0 and 1)">
      <ghg:MeasureValue>0.714</ghg:MeasureValue>
    </ghg:ConcentrationofCO2WeightPercent>
    <ghg:StandardofMeasureforCO2>Standard K</ghg:StandardofMeasureforCO2>
    <ghg:DensityofCO2 densityUOM="mton/scm">
      <ghg:MeasureValue>30.24</ghg:MeasureValue>
    </ghg:DensityofCO2>
    <ghg:MethodofMeasureforCO2Density>Standard J</ghg:MethodofMeasureforCO2Density>
  </ghg:VolumeDetails>
  <ghg:VolumeDetails>
    <ghg:QuarterName>Fourth Quarter</ghg:QuarterName>
    <ghg:VolumetricFlowofCO2 volUOM="Standard Cubic Meters">

```

```

        <ghg:MeasureValue>40000.146</ghg:MeasureValue>
      </ghg:VolumeFlowofCO2>
      <ghg:ConcentrationofCO2WeightPercent fractionUOM="fraction (number between 0 and 1)">
        <ghg:MeasureValue>0.814</ghg:MeasureValue>
      </ghg:ConcentrationofCO2WeightPercent>
      <ghg:StandardofMeasureforCO2>Standard K</ghg:StandardofMeasureforCO2>
      <ghg:DensityofCO2 densityUOM="mton/scm">
        <ghg:MeasureValue>40.25</ghg:MeasureValue>
      </ghg:DensityofCO2>
      <ghg:MethodofMeasureforCO2Density>Standard J</ghg:MethodofMeasureforCO2Density>
    </ghg:VolumeDetails>
  </ghg:MeterDetails>
  <ghg:CO2EndUseDetails>
  <ghg:ApplicationName>Food and beverage</ghg:ApplicationName>
    <ghg:ImportExport>All</ghg:ImportExport>
    <ghg:QuantityofCO2 massUOM="Metric Tons">
      <ghg:MeasureValue>100.14</ghg:MeasureValue>
    </ghg:QuantityofCO2>
  </ghg:CO2EndUseDetails>
  <ghg:CO2EndUseDetails>
    <ghg:ApplicationName>Industrial and municipal water/wastewater treatment</ghg:ApplicationName>
    <ghg:ImportExport>All</ghg:ImportExport>
    <ghg:QuantityofCO2 massUOM="Metric Tons">
      <ghg:MeasureValue>200.25</ghg:MeasureValue>
    </ghg:QuantityofCO2>
  </ghg:CO2EndUseDetails>
  <ghg:CO2EndUseDetails>
    <ghg:ApplicationName>Metal fabrication, including welding and cutting</ghg:ApplicationName>
    <ghg:ImportExport>All</ghg:ImportExport>
    <ghg:QuantityofCO2 massUOM="Metric Tons">
      <ghg:MeasureValue>300.36</ghg:MeasureValue>
    </ghg:QuantityofCO2>
  </ghg:CO2EndUseDetails>
  <ghg:CO2EndUseDetails>
    <ghg:ApplicationName>Greenhouse uses for plant growth</ghg:ApplicationName>
    <ghg:ImportExport>All</ghg:ImportExport>
    <ghg:QuantityofCO2 massUOM="Metric Tons">
      <ghg:MeasureValue>400.78</ghg:MeasureValue>
    </ghg:QuantityofCO2>
  </ghg:CO2EndUseDetails>
  <ghg:CO2EndUseDetails>
    <ghg:ApplicationName>Fumigants (e.g., grain storage) and herbicides</ghg:ApplicationName>
    <ghg:ImportExport>All</ghg:ImportExport>
    <ghg:QuantityofCO2 massUOM="Metric Tons">
      <ghg:MeasureValue>500.56</ghg:MeasureValue>
    </ghg:QuantityofCO2>
  </ghg:CO2EndUseDetails>
  <ghg:CO2EndUseDetails>
    <ghg:ApplicationName>Pulp and paper</ghg:ApplicationName>
    <ghg:ImportExport>All</ghg:ImportExport>
    <ghg:QuantityofCO2 massUOM="Metric Tons">
      <ghg:MeasureValue>600.345</ghg:MeasureValue>
    </ghg:QuantityofCO2>
  </ghg:CO2EndUseDetails>
  <ghg:CO2EndUseDetails>

```

```

<ghg:ApplicationName>Cleaning and solvent use</ghg:ApplicationName>
  <ghg:ImportExport>All</ghg:ImportExport>
  <ghg:QuantityofCO2 massUOM="Metric Tons">
    <ghg:MeasureValue>700.58</ghg:MeasureValue>
  </ghg:QuantityofCO2>
</ghg:CO2EndUseDetails>
<ghg:CO2EndUseDetails>
  <ghg:ApplicationName>Fire fighting</ghg:ApplicationName>
  <ghg:ImportExport>All</ghg:ImportExport>
  <ghg:QuantityofCO2 massUOM="Metric Tons">
    <ghg:MeasureValue>800.4345</ghg:MeasureValue>
  </ghg:QuantityofCO2>
</ghg:CO2EndUseDetails>
<ghg:CO2EndUseDetails>
  <ghg:ApplicationName>Transportation and storage of explosives</ghg:ApplicationName>
  <ghg:ImportExport>All</ghg:ImportExport>
  <ghg:QuantityofCO2 massUOM="Metric Tons">
    <ghg:MeasureValue>900.45</ghg:MeasureValue>
  </ghg:QuantityofCO2>
</ghg:CO2EndUseDetails>
<ghg:CO2EndUseDetails>
  <ghg:ApplicationName>Injection of CO2 for enhanced oil and natural gas recovery that is covered by 40 CFR Part 98, Subpart UU
  </ghg:ApplicationName>
  <ghg:ImportExport>All</ghg:ImportExport>
  <ghg:QuantityofCO2 massUOM="Metric Tons">
    <ghg:MeasureValue>1000.76</ghg:MeasureValue>
  </ghg:QuantityofCO2>
</ghg:CO2EndUseDetails>
<ghg:CO2EndUseDetails>
  <ghg:ApplicationName>Geologic sequestration of carbon dioxide that is covered by 40 CFR Part 98, Subpart RR</ghg:ApplicationName>
  <ghg:ImportExport>All</ghg:ImportExport>
  <ghg:QuantityofCO2 massUOM="Metric Tons">
    <ghg:MeasureValue>1100.56</ghg:MeasureValue>
  </ghg:QuantityofCO2>
</ghg:CO2EndUseDetails>
<ghg:CO2EndUseDetails>
  <ghg:ApplicationName>Research and Development</ghg:ApplicationName>
  <ghg:ImportExport>All</ghg:ImportExport>
  <ghg:QuantityofCO2 massUOM="Metric Tons">
    <ghg:MeasureValue>1200.1111</ghg:MeasureValue>
  </ghg:QuantityofCO2>
</ghg:CO2EndUseDetails>
<ghg:CO2EndUseDetails>
  <ghg:ApplicationName>Other</ghg:ApplicationName>
  <ghg:OtherApplicationName>Test Description</ghg:OtherApplicationName>
  <ghg:ImportExport>All</ghg:ImportExport>
  <ghg:QuantityofCO2 massUOM="Metric Tons">
    <ghg:MeasureValue>1300.45</ghg:MeasureValue>
  </ghg:QuantityofCO2>
</ghg:CO2EndUseDetails>
<ghg:EquipmentCalibrationDetails>
  <ghg:MeasuringEquipmentType>Loaded container volume</ghg:MeasuringEquipmentType>
  <ghg:StandardForCalibration>Standard A</ghg:StandardForCalibration>
</ghg:EquipmentCalibrationDetails>
<ghg:ElectricityGeneratingUnitsWithCapturedCo2StreamsDetails>

```

```

    <ghg:GHGRPID>522796</ghg:GHGRPID>
    <ghg:FacilityName>Dencore Generating Unit</ghg:FacilityName>
  </ghg:ElectricityGeneratingUnitsWithCapturedCo2StreamsDetails>
  <ghg:RRFacilitiesWhereCo2TransferredToDetails>
    <ghg:GHGRPID>566355</ghg:GHGRPID t>
    <ghg:FacilityName>First Injection</ghg:ApplicationName>
    <ghg:CO2Quantity massUOM="Metric Tons">
      <ghg:MeasureValue>500.31231</ghg:MeasureValue>
    </ghg:CO2Quantity>
  </ghg:RRFacilitiesWhereCo2TransferredToDetails>
  <ghg:MassVolumeNumberofDaysSubstituted>1</ghg:MassVolumeNumberofDaysSubstituted>
  <ghg:ConcentrationNumberofDaysSubstituted>2</ghg:ConcentrationNumberofDaysSubstituted>
  <ghg:DensityNumberofDaysSubstituted>3</ghg:DensityNumberofDaysSubstituted>
</ghg:SubPartPP>
</ghg:SubPartInformation>
</ghg:FacilitySiteDetails>
<ghg:CalculationMethodologyChangesDescription/>
<ghg:BestAvailableMonitoringMethodsUsed/>
<ghg:StartDate>2013-01-01</ghg:StartDate>
<ghg:EndDate>2013-12-31</ghg:EndDate>
<ghg:DateTimeReportGenerated>2014-02-24T10:16:31</ghg:DateTimeReportGenerated>
</ghg:FacilitySiteInformation>
</ghg:GHG>
```



## 4.0 Capture Facility – Flow Meters 1 and Streams

### [98.423(a)(3)(i) and 98.423(b)]

*(Note: Data values do not reflect an actual facility's emissions. Additional sample XML files for Subpart PP are posted on the e-GGRT help site.)*

```
<ghg:GHG xmlns="http://www.ccdsupport.com/schema/ghg">
  <ghg:FacilitySiteInformation>
    <ghg:CertificationStatement>The designated representative or alternate designated representative must sign (i.e., agree to) this certification statement. If you are an agent and you click on "SUBMIT", you are not agreeing to the certification statement, but are submitting the certification statement on behalf of the designated representative or alternate designated representative who is agreeing to the certification statement. An agent is only authorized to make the electronic submission on behalf of the designated representative, not to sign (i.e., agree to) the certification statement.</ghg:CertificationStatement>
    <ghg:ReportingYear>2013</ghg:ReportingYear>
    <ghg:FacilitySiteDetails>
      <ghg:FacilitySite>
        <ghg:FacilitySiteIdentifier>524117</ghg:FacilitySiteIdentifier>
        <ghg:FacilitySiteName>Capture- Streams TEST Facility</ghg:FacilitySiteName>
      </ghg:FacilitySite>
      <ghg:LocationAddress>
        <ghg:LocationAddressText>12600 S. ANY STREET</ghg:LocationAddressText>
        <ghg:LocalityName>CHICAGO</ghg:LocalityName>
        <ghg:StateIdentity>
          <ghg:StateCode>IL</ghg:StateCode>
        </ghg:StateIdentity>
        <ghg:AddressPostalCode>60633</ghg:AddressPostalCode>
      </ghg:LocationAddress>
      <ghg:CogenerationUnitEmissionsIndicator>N</ghg:CogenerationUnitEmissionsIndicator>
      <ghg:PrimaryNAICSCode>325120</ghg:PrimaryNAICSCode>
      <ghg:ParentCompanyDetails>
        <ghg:ParentCompany>
          <ghg:ParentCompanyLegalName>Soda Ash Corporation</ghg:ParentCompanyLegalName>
          <ghg:StreetAddress>108 Hillcrest Street</ghg:StreetAddress>
          <ghg:City>Sandpoint</ghg:City>
          <ghg:State>ID</ghg:State>
          <ghg:Zip>83864</ghg:Zip>
          <ghg:PercentOwnershipInterest>100.0</ghg:PercentOwnershipInterest>
        </ghg:ParentCompany>
      </ghg:ParentCompanyDetails>
      <ghg:TotalNonBiogenicCO2eFacilitySubpartsCtoJJ massUOM="Metric Tons">0</ghg:TotalNonBiogenicCO2eFacilitySubpartsCtoJJ>
      <ghg:TotalBiogenicCO2FacilitySubpartsCtoJJ massUOM="Metric Tons">0</ghg:TotalBiogenicCO2FacilitySubpartsCtoJJ>
      <ghg:TotalCO2eSupplierSubpartsKktoPP massUOM="Metric Tons">3490000.3</ghg:TotalCO2eSupplierSubpartsKktoPP>
    </ghg:SubPartInformation>
    <ghg:SubPartPP>
      <ghg:GHGasInfoDetails>
        <ghg:GHGasName>Carbon Dioxide</ghg:GHGasName>
        <ghg:GHGasQuantity massUOM="Metric Tons">
          <ghg:CalculatedValue>3490000.3</ghg:CalculatedValue>
        </ghg:GHGasQuantity>
      </ghg:GHGasInfoDetails>
      <ghg:FacilityClassification>capture 98.420(a)(1)</ghg:FacilityClassification>
      <ghg:CalculationMethodology>Flow Meters 1 and Streams</ghg:CalculationMethodology>
      <ghg:MeterDetails>
```

```

<ghg:UnitIdentification>
  <ghg:UnitName>Capture Flow Meter 1</ghg:UnitName>
  <ghg:UnitDescription>Capture Flow Meter 1 and Stream Example</ghg:UnitDescription>
  <ghg:UnitType>CO2 Flow Meter</ghg:UnitType>
</ghg:UnitIdentification>
<ghg:MassorVolume>Volumetric - concentration in weight percentage</ghg:MassorVolume>
<ghg:AnnualMassofCO2 massUOM="Metric Tons">
  <ghg:MeasureValue>3490000.3</ghg:MeasureValue>
</ghg:AnnualMassofCO2>
<ghg:MeterSegregationLocation>NA</ghg:MeterSegregationLocation>
<ghg:MeterImportExport>NA</ghg:MeterImportExport>
<ghg:BiogenicStreamPercent>
  <ghg:MeasureValue>0.05</ghg:MeasureValue>
</ghg:BiogenicStreamPercent>
<ghg:FlowMeterEquipmentLocationDetails>
  <ghg:isDehydrationEquipmentUpStreamIndicator>N</ghg:isDehydrationEquipmentUpStreamIndicator>
  <ghg:isDehydrationEquipmentDownStreamIndicator>N</ghg:isDehydrationEquipmentDownStreamIndicator>
  <ghg:isCompressionEquipmentUpStreamIndicator>Y</ghg:isCompressionEquipmentUpStreamIndicator>
  <ghg:isCompressionEquipmentDownStreamIndicator>N</ghg:isCompressionEquipmentDownStreamIndicator>
  <ghg:isOtherProcessingEquipmentUpStreamIndicator>N</ghg:isOtherProcessingEquipmentUpStreamIndicator>
  <ghg:isOtherProcessingEquipmentDownStreamIndicator>N</ghg:isOtherProcessingEquipmentDownStreamIndicator>
</ghg:FlowMeterEquipmentLocationDetails>
<ghg:VolumeDetails>
  <ghg:QuarterName>First Quarter</ghg:QuarterName>
  <ghg:VolumetricFlowofCO2>
    <ghg:MeasureValue>39000.34535</ghg:MeasureValue>
  </ghg:VolumetricFlowofCO2>
  <ghg:ConcentrationofCO2WeightPercent fractionUOM="fraction (number between 0 and 1)">
    <ghg:MeasureValue>0.5</ghg:MeasureValue>
  </ghg:ConcentrationofCO2WeightPercent>
  <ghg:StandardofMeasureforCO2>Standard J</ghg:StandardofMeasureforCO2>
  <ghg:DensityofCO2 densityUOM="mton/scm">
    <ghg:MeasureValue>20.325</ghg:MeasureValue>
  </ghg:DensityofCO2>
  <ghg:MethodofMeasureforCO2Density>Standard J</ghg:MethodofMeasureforCO2Density>
</ghg:VolumeDetails>
<ghg:VolumeDetails>
  <ghg:QuarterName>Second Quarter</ghg:QuarterName>
  <ghg:VolumetricFlowofCO2>
    <ghg:MeasureValue>25000.1</ghg:MeasureValue>
  </ghg:VolumetricFlowofCO2>
  <ghg:ConcentrationofCO2WeightPercent fractionUOM="fraction (number between 0 and 1)">
    <ghg:MeasureValue>0.647</ghg:MeasureValue>
  </ghg:ConcentrationofCO2WeightPercent>
  <ghg:StandardofMeasureforCO2>Standard J</ghg:StandardofMeasureforCO2>
  <ghg:DensityofCO2 densityUOM="mton/scm">
    <ghg:MeasureValue>20.25</ghg:MeasureValue>
  </ghg:DensityofCO2>
  <ghg:MethodofMeasureforCO2Density>Standard J</ghg:MethodofMeasureforCO2Density>
</ghg:VolumeDetails>
<ghg:VolumeDetails>
  <ghg:QuarterName>Third Quarter</ghg:QuarterName>
  <ghg:VolumetricFlowofCO2>
    <ghg:MeasureValue>37000.23</ghg:MeasureValue>
  </ghg:VolumetricFlowofCO2>

```



```

    </ghg:V olumetricFlowofCO2>
    <ghg:C oncentrationofCO2WeightPercent fractionUOM="fraction (number between 0 and 1)">
      <ghg:M easureValue>0.5</ghg:MeasureValue>
    </ghg:C oncentrationofCO2WeightPercent>
    <ghg:S tandardofMeasureforCO2>Standard K</ghg:StandardofMeasureforCO2>
    <ghg:D ensityofCO2 densityUOM="mton/scm">
      <ghg:M easureValue>20.5</ghg:MeasureValue>
    </ghg:D ensityofCO2>
    <ghg:M ethodofMeasureforCO2Density>Standard K</ghg:M ethodofMeasureforCO2Density>
  </ghg:V olumeDetails>
<ghg:V olumeDetails>
  <ghg:Q uarterName>Third Quarter</ghg:Q uarterName>
  <ghg:V olumetricFlowofCO2>
    <ghg:M easureValue>1000</ghg:MeasureV alue>
  </ghg:V olumetricFlowofCO2>
  <ghg:C oncentrationofCO2WeightPercent fractionUOM="fraction (number between 0 and 1)">
    <ghg:M easureValue>0.5</ghg:MeasureValue>
  </ghg:C oncentrationofCO2WeightPercent>
  <ghg:S tandardofMeasureforCO2>Standard K</ghg:StandardofMeasureforCO2>
  <ghg:D ensityofCO2 densityUOM="mton/scm">
    <ghg:M easureValue>20.5</ghg:MeasureValue>
  </ghg:D ensityofCO2>
  <ghg:M ethodofMeasureforCO2Density>Standard K</ghg:M ethodofMeasureforCO2Density>
</ghg:V olumeDetails>
<ghg:V olumeDetails>
  <ghg:Q uarterName>Fourth Quarter</ghg:Q uarterName>
  <ghg:V olumetricFlowofCO2>
    <ghg:M easureValue>1000</ghg:MeasureV alue>
  </ghg:V olumetricFlowofCO2>
  <ghg:C oncentrationofCO2WeightPercent fractionUOM="fraction (number between 0 and 1)">
    <ghg:M easureValue>0.5</ghg:MeasureValue>
  </ghg:C oncentrationofCO2WeightPercent>
  <ghg:S tandardofMeasureforCO2>Standard K</ghg:StandardofMeasureforCO2>
  <ghg:D ensityofCO2 densityUOM="mton/scm">
    <ghg:M easureValue>20.5</ghg:MeasureValue>
  </ghg:D ensityofCO2>
  <ghg:M ethodofMeasureforCO2Density>Standard K</ghg:M ethodofMeasureforCO2Density>
</ghg:V olumeDetails>
</ghg:M eterDetails>
<ghg:CO2EndUseDetails>
<ghg:A pplicationName>Food and beverage</ghg:ApplicationName>
  <ghg:I mportExport>All</ghg:ImportExport>
  <ghg:Q uantityofCO2 massUOM="Metric Tons">
    <ghg:M easureValue>100.14</ghg:MeasureValue>
  </ghg:Q uantityofCO2>
</ghg:CO2EndUseDetails>
<ghg:CO2EndUseDetails>
  <ghg:A pplicationName>Industrial and municipal water/wastewater treatment</ghg:ApplicationName>
  <ghg:I mportExport>All</ghg:ImportExport>
  <ghg:Q uantityofCO2 massUOM="Metric Tons">
    <ghg:M easureValue>200.25</ghg:MeasureValue>
  </ghg:Q uantityofCO2>
</ghg:CO2EndUseDetails>
<ghg:CO2EndUseDetails>
  <ghg:A pplicationName>Metal fabrication, including welding and cutting</ghg:ApplicationName>

```

```

    <ghg:ImportExport>All</ghg:ImportExport>
    <ghg:QuantityofCO2 massUOM="Metric Tons">
      <ghg:MeasureValue>300.36</ghg:MeasureValue>
    </ghg:QuantityofCO2>
  </ghg:CO2EndUseDetails>
  <ghg:CO2EndUseDetails>
    <ghg:ApplicationName>Greenhouse uses for plant growth</ghg:ApplicationName>
    <ghg:ImportExport>All</ghg:ImportExport>
    <ghg:QuantityofCO2 massUOM="Metric Tons">
      <ghg:MeasureValue>400.78</ghg:MeasureValue>
    </ghg:QuantityofCO2>
  </ghg:CO2EndUseDetails>
  <ghg:CO2EndUseDetails>
    <ghg:ApplicationName>Fumigants (e.g., grain storage) and herbicides</ghg:ApplicationName>
    <ghg:ImportExport>All</ghg:ImportExport>
    <ghg:QuantityofCO2 massUOM="Metric Tons">
      <ghg:MeasureValue>500.56</ghg:MeasureValue>
    </ghg:QuantityofCO2>
  </ghg:CO2EndUseDetails>
  <ghg:CO2EndUseDetails>
    <ghg:ApplicationName>Pulp and paper</ghg:ApplicationName>
    <ghg:ImportExport>All</ghg:ImportExport>
    <ghg:QuantityofCO2 massUOM="Metric Tons">
      <ghg:MeasureValue>600.345</ghg:MeasureValue>
    </ghg:QuantityofCO2>
  </ghg:CO2EndUseDetails>
  <ghg:CO2EndUseDetails>
    <ghg:ApplicationName>Cleaning and solvent use</ghg:ApplicationName>
    <ghg:ImportExport>All</ghg:ImportExport>
    <ghg:QuantityofCO2 massUOM="Metric Tons">
      <ghg:MeasureValue>700.58</ghg:MeasureValue>
    </ghg:QuantityofCO2>
  </ghg:CO2EndUseDetails>
  <ghg:CO2EndUseDetails>
    <ghg:ApplicationName>Fire fighting</ghg:ApplicationName>
    <ghg:ImportExport>All</ghg:ImportExport>
    <ghg:QuantityofCO2 massUOM="Metric Tons">
      <ghg:MeasureValue>800.4345</ghg:MeasureValue>
    </ghg:QuantityofCO2>
  </ghg:CO2EndUseDetails>
  <ghg:CO2EndUseDetails>
    <ghg:ApplicationName>Transportation and storage of explosives</ghg:ApplicationName>
    <ghg:ImportExport>All</ghg:ImportExport>
    <ghg:QuantityofCO2 massUOM="Metric Tons">
      <ghg:MeasureValue>900.45</ghg:MeasureValue>
    </ghg:QuantityofCO2>
  </ghg:CO2EndUseDetails>
  <ghg:CO2EndUseDetails>
    <ghg:ApplicationName>Injection of CO2 for enhanced oil and natural gas recovery that is covered by 40 CFR Part 98, Subpart UU
    </ghg:ApplicationName>
    <ghg:ImportExport>All</ghg:ImportExport>
    <ghg:QuantityofCO2 massUOM="Metric Tons">
      <ghg:MeasureValue>1000.76</ghg:MeasureValue>
    </ghg:QuantityofCO2>
  </ghg:CO2EndUseDetails>

```

```

    <ghg:CO2EndUseDetails>
      <ghg:ApplicationName>Geologic sequestration of carbon dioxide that is covered by 40 CFR Part 98, Subpart RR</ghg:ApplicationName>
      <ghg:ImportExport>All</ghg:ImportExport>
      <ghg:QuantityofCO2 massUOM="Metric Tons">
        <ghg:MeasureValue>1100.56</ghg:MeasureValue>
      </ghg:QuantityofCO2>
    </ghg:CO2EndUseDetails>
    <ghg:CO2EndUseDetails>
      <ghg:ApplicationName>Research and Development</ghg:ApplicationName>
      <ghg:ImportExport>All</ghg:ImportExport>
      <ghg:QuantityofCO2 massUOM="Metric Tons">
        <ghg:MeasureValue>1200.1111</ghg:MeasureValue>
      </ghg:QuantityofCO2>
    </ghg:CO2EndUseDetails>
    <ghg:CO2EndUseDetails>
      <ghg:ApplicationName>Other</ghg:ApplicationName>
      <ghg:OtherApplicationName>Test Description</ghg:OtherApplicationName>
      <ghg:ImportExport>All</ghg:ImportExport>
      <ghg:QuantityofCO2 massUOM="Metric Tons">
        <ghg:MeasureValue>1300.45</ghg:MeasureValue>
      </ghg:QuantityofCO2>
    </ghg:CO2EndUseDetails>
    <ghg:EquipmentCalibrationDetails>
      <ghg:MeasuringEquipmentType>Volumetric flow meter</ghg:MeasuringEquipmentType>
    </ghg:EquipmentCalibrationDetails>
    <ghg:EquipmentCalibrationDetails>
      <ghg:MeasuringEquipmentType>Loaded container volume</ghg:MeasuringEquipmentType>
      <ghg:StandardForCalibration>Standard L</ghg:StandardForCalibration>
    </ghg:EquipmentCalibrationDetails>
    <ghg:MassVolumeNumberofDaysSubstituted>5</ghg:MassVolumeNumberofDaysSubstituted>
    <ghg:ConcentrationNumberofDaysSubstituted>12</ghg:ConcentrationNumberofDaysSubstituted>
    <ghg:DensityNumberofDaysSubstituted>3</ghg:DensityNumberofDaysSubstituted>
  </ghg:SubPartPP>
</ghg:SubPartInformation>
</ghg:FacilitySiteDetails>
<ghg:CalculationMethodologyChangesDescription/>
<ghg:BestAvailableMonitoringMethodsUsed/>
<ghg:StartDate>2013-01-01</ghg:StartDate>
<ghg:EndDate>2013-12-31</ghg:EndDate>
<ghg:DateTimeReportGenerated>2014-02-24T10:16:31</ghg:DateTimeReportGenerated>
</ghg:FacilitySiteInformation>
</ghg:GHG>

```

## 5.0 Extract Facility – Flow Meters 1

### [98.423(a)(3)(i)]

*(Note: Data values do not reflect an actual facility's emissions. Additional sample XML files for Subpart PP are posted on the e-GGRT help site.)*

```
<ghg:GHG xmlns="http://www.ccdsupport.com/schema/ghg">
  <ghg:FacilitySiteInformation>
    <ghg:CertificationStatement>The designated representative or alternate designated representative must sign (i.e., agree to) this certification statement. If you are an agent and you click on "SUBMIT", you are not agreeing to the certification statement, but are submitting the certification statement on behalf of the designated representative or alternate designated representative who is agreeing to the certification statement. An agent is only authorized to make the electronic submission on behalf of the designated representative, not to sign (i.e., agree to) the certification statement. </ghg:CertificationStatement>
    <ghg:ReportingYear>2013</ghg:ReportingYear>
    <ghg:FacilitySiteDetails>
      <ghg:FacilitySite>
        <ghg:FacilitySiteIdentifier>524117</ghg:FacilitySiteIdentifier>
        <ghg:FacilitySiteName>Extract- Flow Meters 3 TEST Facility</ghg:FacilitySiteName>
      </ghg:FacilitySite>
      <ghg:LocationAddress>
        <ghg:LocationAddressText>12600 S. ANY STREET</ghg:LocationAddressText>
        <ghg:LocalityName>CHICAGO</ghg:LocalityName>
        <ghg:StateIdentity>
          <ghg:StateCode>IL</ghg:StateCode>
        </ghg:StateIdentity>
        <ghg:AddressPostalCode>60633</ghg:AddressPostalCode>
      </ghg:LocationAddress>
      <ghg:CogenerationUnitEmissionsIndicator>N</ghg:CogenerationUnitEmissionsIndicator>
      <ghg:PrimaryNAICSCode>325120</ghg:PrimaryNAICSCode>
      <ghg:ParentCompanyDetails>
        <ghg:ParentCompany>
          <ghg:ParentCompanyLegalName>Soda Ash Corporation</ghg:ParentCompanyLegalName>
          <ghg:StreetAddress>108 Hillcrest Street</ghg:StreetAddress>
          <ghg:City>Sandpoint</ghg:City>
          <ghg:State>ID</ghg:State>
          <ghg:Zip>83864</ghg:Zip>
          <ghg:PercentOwnershipInterest>100.0</ghg:PercentOwnershipInterest>
        </ghg:ParentCompany>
      </ghg:ParentCompanyDetails>
      <ghg>TotalNonBiogenicCO2eFacilitySubpartsCtoJJ massUOM="Metric Tons">0</ghg>TotalNonBiogenicCO2eFacilitySubpartsCtoJJ>
      <ghg>TotalBiogenicCO2FacilitySubpartsCtoJJ massUOM="Metric Tons">0</ghg>TotalBiogenicCO2FacilitySubpartsCtoJJ>
      <ghg>TotalCO2eSupplierSubpartsKktoPP massUOM="Metric Tons">700.1</ghg>TotalCO2eSupplierSubpartsKktoPP>
    </ghg:SubPartInformation>
    <ghg:SubPartPP>
      <ghg:GHGasInfoDetails>
        <ghg:GHGasName>Carbon Dioxide</ghg:GHGasName>
        <ghg:GHGasQuantity massUOM="Metric Tons">
          <ghg:CalculatedValue>462.1</ghg:CalculatedValue>
        </ghg:GHGasQuantity>
      </ghg:GHGasInfoDetails>
      <ghg:FacilityClassification>extract 98.420(a)(2)</ghg:FacilityClassification>
      <ghg:CalculationMethodology>Flow Meters 1</ghg:CalculationMethodology>
    </ghg:SubPartPP>
  </ghg:FacilitySiteInformation>
</ghg:GHG>
```

```

<ghg:MeterDetails>
  <ghg:UnitIdentification>
    <ghg:UnitName>Flow Meter 011 </ghg:UnitName>
    <ghg:UnitDescription>Extract flow meter011 </ghg:UnitDescription>
    <ghg:UnitType>CO2 Flow Meter</ghg:UnitType>
  </ghg:UnitIdentification>
  <ghg:MassorVolume>Volumetric – concentration in volume percentage </ghg:MassorVolume>
  <ghg:AnnualMassofCO2 massUOM="Metric Tons">
    <ghg:MeasureValue>540.1 </ghg:MeasureValue>
  </ghg:AnnualMassofCO2>
  <ghg:FlowMeterEquipmentLocationDetails>
    <ghg:isDehydrationEquipmentUpStreamIndicator>N </ghg:isDehydrationEquipmentUpStreamIndicator>
    <ghg:isDehydrationEquipmentDownStreamIndicator>N </ghg:isDehydrationEquipmentDownStreamIndicator>
    <ghg:isCompressionEquipmentUpStreamIndicator>Y </ghg:isCompressionEquipmentUpStreamIndicator>
    <ghg:isCompressionEquipmentDownStreamIndicator>N </ghg:isCompressionEquipmentDownStreamIndicator>
    <ghg:isOtherProcessingEquipmentUpStreamIndicator>N </ghg:isOtherProcessingEquipmentUpStreamIndicator>
    <ghg:isOtherProcessingEquipmentDownStreamIndicator>N </ghg:isOtherProcessingEquipmentDownStreamIndicator>
    <ghg:OtherProcessingEquipmentDescription>Processing equipment description </ghg:OtherProcessingEquipmentDescription>
  </ghg:FlowMeterEquipmentLocationDetails>
  <ghg:VolumeDetails>
    <ghg:QuarterName>First Quarter </ghg:QuarterName>
    <ghg:VolumetricFlowofCO2>
      <ghg:MeasureValue>5000 </ghg:MeasureValue>
    </ghg:VolumetricFlowofCO2>
    <ghg:ConcentrationofCO2VolumePercent fractionUOM="fraction (number between 0 and 1)">
      <ghg:MeasureValue>0.33 </ghg:MeasureValue>
    </ghg:ConcentrationofCO2VolumePercent>
    <ghg:DensityofCO2 densityUOM="mton/scm">
      <MeasureValue>0.001868 </ghg:MeasureValue>
    </ghg:DensityofCO2>
  </ghg:VolumeDetails>
  <ghg:VolumeDetails>
    <ghg:QuarterName>Second Quarter </ghg:QuarterName>
    <ghg:VolumetricFlowofCO2>
      <ghg:MeasureValue>5000 </ghg:MeasureValue>
    </ghg:VolumetricFlowofCO2>
    <ghg:ConcentrationofCO2VolumePercent fractionUOM="fraction (number between 0 and 1)">
      <ghg:MeasureValue>0.33 </ghg:MeasureValue>
    </ghg:ConcentrationofCO2VolumePercent>
    <ghg:DensityofCO2 densityUOM="mton/scm">
      <ghg:MeasureValue>0.001868 </ghg:MeasureValue>
    </ghg:DensityofCO2>
  </ghg:VolumeDetails>
  <ghg:VolumeDetails>
    <ghg:QuarterName>Third Quarter </ghg:QuarterName>
    <ghg:VolumetricFlowofCO2>
      <ghg:MeasureValue>5000 </ghg:MeasureValue>
    </ghg:VolumetricFlowofCO2>
    <ghg:ConcentrationofCO2VolumePercent fractionUOM="fraction (number between 0 and 1)">
      <ghg:MeasureValue>0.33 </ghg:MeasureValue>
    </ghg:ConcentrationofCO2VolumePercent>
    <ghg:DensityofCO2 densityUOM="mton/scm">
      <ghg:MeasureValue>0.001868 </ghg:MeasureValue>
    </ghg:DensityofCO2>
  </ghg:VolumeDetails>

```



```

    <ghg:VolumeDetails>
      <ghg:QuarterName>Fourth Quarter</ghg:QuarterName>
      <ghg:VolumetricFlowofCO2>
        <ghg:MeasureValue>5000</ghg:MeasureValue>
      </ghg:VolumetricFlowofCO2>
      <ghg:ConcentrationofCO2VolumePercent fractionUOM="fraction (number between 0 and 1)">
        <ghg:MeasureValue>0.33</ghg:MeasureValue>
      </ghg:ConcentrationofCO2VolumePercent>
      <ghg:DensityofCO2 densityUOM="mton/scm">
        <ghg:MeasureValue>0.001868</ghg:MeasureValue>
      </ghg:DensityofCO2>
    </ghg:VolumeDetails>
  </ghg:MeterDetails>
  <ghg:CO2EndUseDetails>
    <ghg:ApplicationName>Food and beverage</ghg:ApplicationName>
    <ghg:ImportExport>All</ghg:ImportExport>
    <ghg:QuantityofCO2 massUOM="Metric Tons">
      <ghg:MeasureValue>100.478</ghg:MeasureValue>
    </ghg:QuantityofCO2>
  </ghg:CO2EndUseDetails>
  <ghg:CO2EndUseDetails>
    <ghg:ApplicationName>Industrial and municipal water/wastewater treatment</ghg:ApplicationName>
    <ghg:ImportExport>All</ghg:ImportExport>
    <ghg:QuantityofCO2 massUOM="Metric Tons">
      <ghg:MeasureValue>200.278</ghg:MeasureValue>
    </ghg:QuantityofCO2>
  </ghg:CO2EndUseDetails>
  <ghg:CO2EndUseDetails>
    <ghg:ApplicationName>Metal fabrication, including welding and cutting</ghg:ApplicationName>
    <ghg:ImportExport>All</ghg:ImportExport>
    <ghg:QuantityofCO2 massUOM="Metric Tons">
      <ghg:MeasureValue>300.232</ghg:MeasureValue>
    </ghg:QuantityofCO2>
  </ghg:CO2EndUseDetails>
  <ghg:CO2EndUseDetails>
    <ghg:ApplicationName>Greenhouse uses for plant growth</ghg:ApplicationName>
    <ghg:ImportExport>All</ghg:ImportExport>
    <ghg:QuantityofCO2 massUOM="Metric Tons">
      <ghg:MeasureValue>400.78</ghg:MeasureValue>
    </ghg:QuantityofCO2>
  </ghg:CO2EndUseDetails>
  <ghg:CO2EndUseDetails>
    <ghg:ApplicationName>Fumigants (e.g., grain storage) and herbicides</ghg:ApplicationName>
    <ghg:ImportExport>All</ghg:ImportExport>
    <ghg:QuantityofCO2 massUOM="Metric Tons">
      <ghg:MeasureValue>500.234</ghg:MeasureValue>
    </ghg:QuantityofCO2>
  </ghg:CO2EndUseDetails>
  <ghg:CO2EndUseDetails>
    <ghg:ApplicationName>Pulp and paper</ghg:ApplicationName>
    <ghg:ImportExport>All</ghg:ImportExport>
    <ghg:QuantityofCO2 massUOM="Metric Tons">
      <ghg:MeasureValue>600.78</ghg:MeasureValue>
    </ghg:QuantityofCO2>
  </ghg:CO2EndUseDetails>

```

```

<ghg:CO2EndUseDetails>
  <ghg:ApplicationName>Cleaning and solvent use</ghg:ApplicationName>
  <ghg:ImportExport>All</ghg:ImportExport>
  <ghg:QuantityofCO2 massUOM="Metric Tons">
    <ghg:MeasureValue>700.78</ghg:MeasureValue>
  </ghg:QuantityofCO2>
</ghg:CO2EndUseDetails>
<ghg:CO2EndUseDetails>
  <ghg:ApplicationName>Fire fighting</ghg:ApplicationName>
  <ghg:ImportExport>All</ghg:ImportExport>
  <ghg:QuantityofCO2 massUOM="Metric Tons">
    <ghg:MeasureValue>800.3698</ghg:MeasureValue>
  </ghg:QuantityofCO2>
</ghg:CO2EndUseDetails>
<ghg:CO2EndUseDetails>
  <ghg:ApplicationName>Transportation and storage of explosives</ghg:ApplicationName>
  <ghg:ImportExport>All</ghg:ImportExport>
  <ghg:QuantityofCO2 massUOM="Metric Tons">
    <ghg:MeasureValue>900.123</ghg:MeasureValue>
  </ghg:QuantityofCO2>
</ghg:CO2EndUseDetails>
<ghg:CO2EndUseDetails>
  <ghg:ApplicationName>Injection of CO2 for enhanced oil and natural gas recovery that is covered by 40 CFR Part 98, Subpart UU
  </ghg:ApplicationName>
  <ghg:ImportExport>All</ghg:ImportExport>
  <ghg:QuantityofCO2 massUOM="Metric Tons">
    <ghg:MeasureValue>1000.8979</ghg:MeasureValue>
  </ghg:QuantityofCO2>
</ghg:CO2EndUseDetails>
<ghg:CO2EndUseDetails>
  <ghg:ApplicationName>Geologic sequestration of carbon dioxide that is covered by 40 CFR Part 98, Subpart RR</ghg:ApplicationName>
  <ghg:ImportExport>All</ghg:ImportExport>
  <ghg:QuantityofCO2 massUOM="Metric Tons">
    <ghg:MeasureValue>1100.278</ghg:MeasureValue>
  </ghg:QuantityofCO2>
</ghg:CO2EndUseDetails>
<ghg:CO2EndUseDetails>
  <ghg:ApplicationName>Research and Development</ghg:ApplicationName>
  <ghg:ImportExport>All</ghg:ImportExport>
  <ghg:QuantityofCO2 massUOM="Metric Tons">
    <ghg:MeasureValue>1200.45</ghg:MeasureValue>
  </ghg:QuantityofCO2>
</ghg:CO2EndUseDetails>
<ghg:CO2EndUseDetails>
  <ghg:ApplicationName>Other</ghg:ApplicationName>
  <ghg:OtherApplicationName>Test Description</ghg:OtherApplicationName>
  <ghg:ImportExport>All</ghg:ImportExport>
  <ghg:QuantityofCO2 massUOM="Metric Tons">
    <ghg:MeasureValue>1300.33</ghg:MeasureValue>
  </ghg:QuantityofCO2>
</ghg:CO2EndUseDetails>
<ghg:EquipmentCalibrationDetails>
  <ghg:MeasuringEquipmentType>Volumetric flow meter</ghg:MeasuringEquipmentType>
</ghg:EquipmentCalibrationDetails>
<ghg:MassVolumeNumberofDaysSubstituted>1</ghg:MassVolumeNumberofDaysSubstituted>

```

```
<ghg:ConcentrationNumberofDaysSubstituted>2</ghg:ConcentrationNumberofDaysSubstituted>
<ghg:DensityNumberofDaysSubstituted>3</ghg:DensityNumberofDaysSubstituted>
</ghg:SubPartPP>
</ghg:SubPartInformation>
</ghg:FacilitySiteDetails>
<ghg:CalculationMethodologyChangesDescription/>
<ghg:BestAvailableMonitoringMethodsUsed/>
<ghg:StartDate>2013-01-01</ghg:StartDate>
<ghg:EndDate>2013-12-31</ghg:EndDate>
<ghg:DateTimeReportGenerated>2014-02-24T10:16:31</ghg:DateTimeReportGenerated>
</ghg:FacilitySiteInformation>
</ghg:GHG>
```

## 6.0 Extract Facility – Flow Meters 3

### [98.423(a)(3)(i)]

*(Note: Data values do not reflect an actual facility's emissions. Additional sample XML files for Subpart PP are posted on the e-GGRT help site.)*

```
<ghg:GHG xmlns="http://www.ccdsupport.com/schema/ghg">
  <ghg:FacilitySiteInformation>
    <ghg:CertificationStatement>The designated representative or alternate designated representative must sign (i.e., agree to) this certification statement. If you are an agent and you click on "SUBMIT", you are not agreeing to the certification statement, but are submitting the certification statement on behalf of the designated representative or alternate designated representative who is agreeing to the certification statement. An agent is only authorized to make the electronic submission on behalf of the designated representative, not to sign (i.e., agree to) the certification statement.</ghg:CertificationStatement>
    <ghg:ReportingYear>2013</ghg:ReportingYear>
    <ghg:FacilitySiteDetails>
      <ghg:FacilitySite>
        <ghg:FacilitySiteIdentifier>524117</ghg:FacilitySiteIdentifier>
        <ghg:FacilitySiteName>Extract- Flow Meters 3 TEST Facility</ghg:FacilitySiteName>
      </ghg:FacilitySite>
      <ghg:LocationAddress>
        <ghg:LocationAddressText>12600 S. ANY STREET</ghg:LocationAddressText>
        <ghg:LocalityName>CHICAGO</ghg:LocalityName>
        <ghg:StateIdentity>
          <ghg:StateCode>IL</ghg:StateCode>
        </ghg:StateIdentity>
        <ghg:AddressPostalCode>60633</ghg:AddressPostalCode>
      </ghg:LocationAddress>
      <ghg:CogenerationUnitEmissionsIndicator>N</ghg:CogenerationUnitEmissionsIndicator>
      <ghg:PrimaryNAICSCode>325120</ghg:PrimaryNAICSCode>
      <ghg:ParentCompanyDetails>
        <ghg:ParentCompany>
          <ghg:ParentCompanyLegalName>Soda Ash Corporation</ghg:ParentCompanyLegalName>
          <ghg:StreetAddress>108 Hillcrest Street</ghg:StreetAddress>
          <ghg:City>Sandpoint</ghg:City>
          <ghg:State>ID</ghg:State>
          <ghg:Zip>83864</ghg:Zip>
          <ghg:PercentOwnershipInterest>100.0</ghg:PercentOwnershipInterest>
        </ghg:ParentCompany>
      </ghg:ParentCompanyDetails>
      <ghg:TotalNonBiogenicCO2eFacilitySubpartsCtoJJ massUOM="Metric Tons">0</ghg:TotalNonBiogenicCO2eFacilitySubpartsCtoJJ>
      <ghg:TotalBiogenicCO2FacilitySubpartsCtoJJ massUOM="Metric Tons">0</ghg:TotalBiogenicCO2FacilitySubpartsCtoJJ>
      <ghg:TotalCO2eSupplierSubpartsKktoPP massUOM="Metric Tons">700.1</ghg:TotalCO2eSupplierSubpartsKktoPP>
    </ghg:SubPartInformation>
    <ghg:SubPartPP>
      <ghg:GHGasInfoDetails>
        <ghg:GHGasName>Carbon Dioxide</ghg:GHGasName>
        <ghg:GHGasQuantity massUOM="Metric Tons">
          <ghg:CalculatedValue>700.1</ghg:CalculatedValue>
        </ghg:GHGasQuantity>
      </ghg:GHGasInfoDetails>
    </ghg:SubPartPP>
  </ghg:FacilitySiteInformation>
</ghg:GHG>
```

```

<ghg:FacilityClassification>extract 98.420(a)(2)</ghg:FacilityClassification>
<ghg:CalculationMethodology>Flow Meters 3</ghg:CalculationMethodology>
<ghg:MeterDetails>
  <ghg:UnitIdentification>
    <ghg:UnitName>001 - Mass FM</ghg:UnitName>
    <ghg:UnitDescription>Mass basis flow meter</ghg:UnitDescription>
    <ghg:UnitType>CO2 Flow Meter</ghg:UnitType>
  </ghg:UnitIdentification>
  <ghg:MassorVolume>Mass</ghg:MassorVolume>
  <ghg:AnnualMassofCO2 massUOM="Metric Tons">
    <ghg:MeasureValue>700.1</ghg:MeasureValue>
  </ghg:AnnualMassofCO2>
  <ghg:FlowMeterEquipmentLocationDetails>
    <ghg:isDehydrationEquipmentUpStreamIndicator>Y</ghg:isDehydrationEquipmentUpStreamIndicator>
    <ghg:isDehydrationEquipmentDownStreamIndicator>Y</ghg:isDehydrationEquipmentDownStreamIndicator>
    <ghg:isCompressionEquipmentUpStreamIndicator>Y</ghg:isCompressionEquipmentUpStreamIndicator>
    <ghg:isCompressionEquipmentDownStreamIndicator>Y</ghg:isCompressionEquipmentDownStreamIndicator>
    <ghg:isOtherProcessingEquipmentUpStreamIndicator>Y</ghg:isOtherProcessingEquipmentUpStreamIndicator>
    <ghg:isOtherProcessingEquipmentDownStreamIndicator>Y</ghg:isOtherProcessingEquipmentDownStreamIndicator>
    <ghg:OtherProcessingEquipmentDescription>Processing equipment description</ghg:OtherProcessingEquipmentDescription>
  </ghg:FlowMeterEquipmentLocationDetails>
  <ghg:MassDetails>
    <ghg:QuarterName>First Quarter</ghg:QuarterName>
    <ghg:MassofCO2 massUOM="Metric Tons">
      <ghg:MeasureValue>100.234</ghg:MeasureValue>
    </ghg:MassofCO2>
    <ghg:ConcentrationofCO2 fractionUOM="fraction (number between 0 and 1)">
      <ghg:MeasureValue>0.554</ghg:MeasureValue>
    </ghg:ConcentrationofCO2>
    <ghg:StandardofMeasureforCO2>Standard H</ghg:StandardofMeasureforCO2>
  </ghg:MassDetails>
  <ghg:MassDetails>
    <ghg:QuarterName>Second Quarter</ghg:QuarterName>
    <ghg:MassofCO2 massUOM="Metric Tons">
      <ghg:MeasureValue>200.1</ghg:MeasureValue>
    </ghg:MassofCO2>
    <ghg:ConcentrationofCO2 fractionUOM="fraction (number between 0 and 1)">
      <ghg:MeasureValue>0.678</ghg:MeasureValue>
    </ghg:ConcentrationofCO2>
    <ghg:StandardofMeasureforCO2>Standard H</ghg:StandardofMeasureforCO2>
  </ghg:MassDetails>
  <ghg:MassDetails>
    <ghg:QuarterName>Third Quarter</ghg:QuarterName>
    <ghg:MassofCO2 massUOM="Metric Tons">
      <ghg:MeasureValue>300.9897</ghg:MeasureValue>
    </ghg:MassofCO2>
    <ghg:ConcentrationofCO2 fractionUOM="fraction (number between 0 and 1)">
      <ghg:MeasureValue>0.778</ghg:MeasureValue>
    </ghg:ConcentrationofCO2>
    <ghg:StandardofMeasureforCO2>Standard H</ghg:StandardofMeasureforCO2>
  </ghg:MassDetails>
  <ghg:MassDetails>
    <ghg:QuarterName>Fourth Quarter</ghg:QuarterName>
    <ghg:MassofCO2 massUOM="Metric Tons">
      <ghg:MeasureValue>400.234</ghg:MeasureValue>

```

```

        </ghg:MassofCO2>
        <ghg:ConcentrationofCO2 fractionUOM="fraction (number between 0 and 1)">
          <ghg:MeasureValue>0.878</ghg:MeasureValue>
        </ghg:ConcentrationofCO2>
        <ghg:StandardofMeasureforCO2>Standard H </ghg:StandardofMeasureforCO2>
      </ghg:MassDetails>
    </ghg:MeterDetails>
  <ghg:CO2EndUseDetails>
    <ghg:ApplicationName>Food and beverage </ghg:ApplicationName>
    <ghg:ImportExport>All</ghg:ImportExport>
    <ghg:QuantityofCO2 massUOM="Metric Tons">
      <ghg:MeasureValue>100.478</ghg:MeasureValue>
    </ghg:QuantityofCO2>
  </ghg:CO2EndUseDetails>
  <ghg:CO2EndUseDetails>
    <ghg:ApplicationName>Industrial and municipal water/wastewater treatment</ghg:ApplicationName>
    <ghg:ImportExport>All</ghg:ImportExport>
    <ghg:QuantityofCO2 massUOM="Metric Tons">
      <ghg:MeasureValue>200.278</ghg:MeasureValue>
    </ghg:QuantityofCO2>
  </ghg:CO2EndUseDetails>
  <ghg:CO2EndUseDetails>
    <ghg:ApplicationName>Metal fabrication, including welding and cutting </ghg:ApplicationName>
    <ghg:ImportExport>All</ghg:ImportExport>
    <ghg:QuantityofCO2 massUOM="Metric Tons">
      <ghg:MeasureValue>300.232</ghg:MeasureValue>
    </ghg:QuantityofCO2>
  </ghg:CO2EndUseDetails>
  <ghg:CO2EndUseDetails>
    <ghg:ApplicationName>Greenhouse uses for plant growth</ghg:ApplicationName>
    <ghg:ImportExport>All</ghg:ImportExport>
    <ghg:QuantityofCO2 massUOM="Metric Tons">
      <ghg:MeasureValue>400.78</ghg:MeasureValue>
    </ghg:QuantityofCO2>
  </ghg:CO2EndUseDetails>
  <ghg:CO2EndUseDetails>
    <ghg:ApplicationName>Fumigants (e.g., grain storage) and herbicides </ghg:ApplicationName>
    <ghg:ImportExport>All</ghg:ImportExport>
    <ghg:QuantityofCO2 massUOM="Metric Tons">
      <ghg:MeasureValue>500.234</ghg:MeasureValue>
    </ghg:QuantityofCO2>
  </ghg:CO2EndUseDetails>
  <ghg:CO2EndUseDetails>
    <ghg:ApplicationName>Pulp and paper</ghg:ApplicationName>
    <ghg:ImportExport>All</ghg:ImportExport>
    <ghg:QuantityofCO2 massUOM="Metric Tons">
      <ghg:MeasureValue>600.78</ghg:MeasureValue>
    </ghg:QuantityofCO2>
  </ghg:CO2EndUseDetails>
  <ghg:CO2EndUseDetails>
    <ghg:ApplicationName>Cleaning and solvent use</ghg:ApplicationName>
    <ghg:ImportExport>All</ghg:ImportExport>
    <ghg:QuantityofCO2 massUOM="Metric Tons">
      <ghg:MeasureValue>700.78</ghg:MeasureValue>
    </ghg:QuantityofCO2>
  </ghg:CO2EndUseDetails>

```

```

</ghg:CO2EndUseDetails>
<ghg:CO2EndUseDetails>
  <ghg:ApplicationName>Fire fighting</ghg:ApplicationName>
  <ghg:ImportExport>All</ghg:ImportExport>
  <ghg:QuantityofCO2 massUOM="Metric Tons">
    <ghg:MeasureValue>800.3698</ghg:MeasureValue>
  </ghg:QuantityofCO2>
</ghg:CO2EndUseDetails>
<ghg:CO2EndUseDetails>
  <ghg:ApplicationName>Transportation and storage of explosives</ghg:ApplicationName>
  <ghg:ImportExport>All</ghg:ImportExport>
  <ghg:QuantityofCO2 massUOM="Metric Tons">
    <ghg:MeasureValue>900.123</ghg:MeasureValue>
  </ghg:QuantityofCO2>
</ghg:CO2EndUseDetails>
<ghg:CO2EndUseDetails>
  <ghg:ApplicationName>Injection of CO2 for enhanced oil and natural gas recovery that is covered by 40 CFR Part 98, Subpart UU
</ghg:ApplicationName>
  <ghg:ImportExport>All</ghg:ImportExport>
  <ghg:QuantityofCO2 massUOM="Metric Tons">
    <ghg:MeasureValue>1000.8979</ghg:MeasureValue>
  </ghg:QuantityofCO2>
</ghg:CO2EndUseDetails>
<ghg:CO2EndUseDetails>
  <ghg:ApplicationName>Geologic sequestration of carbon dioxide that is covered by 40 CFR Part 98, Subpart RR</ghg:ApplicationName>
  <ghg:ImportExport>All</ghg:ImportExport>
  <ghg:QuantityofCO2 massUOM="Metric Tons">
    <ghg:MeasureValue>1100.278</ghg:MeasureValue>
  </ghg:QuantityofCO2>
</ghg:CO2EndUseDetails>
<ghg:CO2EndUseDetails>
  <ghg:ApplicationName>Research and Development</ghg:ApplicationName>
  <ghg:ImportExport>All</ghg:ImportExport>
  <ghg:QuantityofCO2 massUOM="Metric Tons">
    <ghg:MeasureValue>1200.45</ghg:MeasureValue>
  </ghg:QuantityofCO2>
</ghg:CO2EndUseDetails>
<ghg:CO2EndUseDetails>
  <ghg:ApplicationName>Other</ghg:ApplicationName>
  <ghg:OtherApplicationName>Test Description</ghg:OtherApplicationName>
  <ghg:ImportExport>All</ghg:ImportExport>
  <ghg:QuantityofCO2 massUOM="Metric Tons">
    <ghg:MeasureValue>1300.33</ghg:MeasureValue>
  </ghg:QuantityofCO2>
</ghg:CO2EndUseDetails>
<ghg:EquipmentCalibrationDetails>
  <ghg:MeasuringEquipmentType>Mass flow meter</ghg:MeasuringEquipmentType>
  <ghg:StandardForCalibration>Standard A</ghg:StandardForCalibration>
</ghg:EquipmentCalibrationDetails>
<ghg:MassVolumeNumberofDaysSubstituted >1</ghg:MassVolumeNumberofDaysSubstituted>
<ghg:ConcentrationNumberofDaysSubstituted >2</ghg:ConcentrationNumberofDaysSubstituted>
<ghg:DensityNumberofDaysSubstituted >3</ghg:DensityNumberofDaysSubstituted>
</ghg:SubPartPP>
</ghg:SubPartInformation>
</ghg:FacilitySiteDetails>

```

```
<ghg:CalculationMethodologyChangesDescription/>  
<ghg:BestAvailableMonitoringMethodsUsed/>  
<ghg:StartDate>2013-01-01</ghg:StartDate>  
<ghg:EndDate>2013-12-31</ghg:EndDate>  
<ghg:DateTimeReportGenerated>2014-02-24T10:16:31</ghg:DateTimeReportGenerated>  
</ghg:FacilitySiteInformation>  
</ghg:GHG>
```



## 7.0 Extract Facility – Flow Meter 1 and Streams

### [98.423(a)(3)(i) and 98.423(b)]

*(Note: Data values do not reflect an actual facility's emissions. Additional sample XML files for Subpart PP are posted on the e-GGRT help site.)*

```
<ghg:GHG xmlns="http://www.ccdsupport.com/schema/ghg">
  <ghg:FacilitySiteInformation>
    <ghg:CertificationStatement>The designated representative or alternate designated representative must sign (i.e., agree to) this certification statement. If you are an agent and you click on "SUBMIT", you are not agreeing to the certification statement, but are submitting the certification statement on behalf of the designated representative or alternate designated representative who is agreeing to the certification statement. An agent is only authorized to make the electronic submission on behalf of the designated representative, not to sign (i.e., agree to) the certification statement.</ghg:CertificationStatement>
    <ghg:ReportingYear>2013</ghg:ReportingYear>
    <ghg:FacilitySiteDetails>
      <ghg:FacilitySite>
        <ghg:FacilitySiteIdentifier>524117</ghg:FacilitySiteIdentifier>
        <ghg:FacilitySiteName>Extract- Flow Meters 3 TEST Facility</ghg:FacilitySiteName>
      </ghg:FacilitySite>
      <ghg:LocationAddress>
        <ghg:LocationAddressText>12600 S. ANY STREET</ghg:LocationAddressText>
        <ghg:LocalityName>CHICAGO</ghg:LocalityName>
        <ghg:StateIdentity>
          <ghg:StateCode>IL</ghg:StateCode>
        </ghg:StateIdentity>
        <ghg:AddressPostalCode>60633</ghg:AddressPostalCode>
      </ghg:LocationAddress>
      <ghg:CogenerationUnitEmissionsIndicator>N</ghg:CogenerationUnitEmissionsIndicator>
      <ghg:PrimaryNAICSCode>325120</ghg:PrimaryNAICSCode>
      <ghg:ParentCompanyDetails>
        <ghg:ParentCompany>
          <ghg:ParentCompanyLegalName>Soda Ash Corporation</ghg:ParentCompanyLegalName>
          <ghg:StreetAddress>108 Hillcrest Street</ghg:StreetAddress>
          <ghg:City>Sandpoint</ghg:City>
          <ghg:State>ID</ghg:State>
          <ghg:Zip>83864</ghg:Zip>
          <ghg:PercentOwnershipInterest>100.0</ghg:PercentOwnershipInterest>
        </ghg:ParentCompany>
      </ghg:ParentCompanyDetails>
      <ghg:TotalNonBiogenicCO2eFacilitySubpartsCtoJJ massUOM="Metric Tons">0</ghg:TotalNonBiogenicCO2eFacilitySubpartsCtoJJ>
      <ghg:TotalBiogenicCO2FacilitySubpartsCtoJJ massUOM="Metric Tons">0</ghg:TotalBiogenicCO2FacilitySubpartsCtoJJ>
      <ghg:TotalCO2eSupplierSubpartsKktoPP massUOM="Metric Tons">700.1</ghg:TotalCO2eSupplierSubpartsKktoPP>
    </ghg:SubPartInformation>
    <ghg:SubPartPP>
      <ghg:GHGasInfoDetails>
        <ghg:GHGasName>Carbon Dioxide</ghg:GHGasName>
        <ghg:GHGasQuantity massUOM="Metric Tons">
          <ghg:CalculatedValue>980.1</ghg:CalculatedValue>
        </ghg:GHGasQuantity>
      </ghg:GHGasInfoDetails>
      <ghg:FacilityClassification>extract 98.420(a)(2)</ghg:FacilityClassification>
    </ghg:SubPartPP>
  </ghg:FacilitySiteInformation>
</ghg:GHG>
```

```

<ghg:CalculationMethodology>Flow Meters 1 and Stream </ghg:CalculationMethodology>
<ghg:MeterDetails>
  <ghg:UnitIdentification>
    <ghg:UnitName>Flow Meter 012 </ghg:UnitName>
    <ghg:UnitDescription>Extract with Flow Meter 1 and Streams Example</ghg:UnitDescription>
    <ghg:UnitType>CO2 Flow Meter</ghg:UnitType>
  </ghg:UnitIdentification>
  <ghg:MassorVolume>Volumetric – concentration in volume percentage </ghg:MassorVolume>
  <ghg:AnnualMassofCO2 massUOM="Metric Tons">
    <ghg:MeasureValue>90.1</ghg:MeasureValue>
  </ghg:AnnualMassofCO2>
  <ghg:MeterSegregationLocation>NA</ghg:MeterSegregationLocation>
  <ghg:MeterImportExport>NA</ghg:MeterImportExport>
  <ghg:FlowMeterEquipmentLocationDetails>
    <ghg:isDehydrationEquipmentUpStreamIndicator>Y</ghg:isDehydrationEquipmentUpStreamIndicator>
    <ghg:isDehydrationEquipmentDownStreamIndicator>Y</ghg:isDehydrationEquipmentDownStreamIndicator>
    <ghg:isCompressionEquipmentUpStreamIndicator>Y</ghg:isCompressionEquipmentUpStreamIndicator>
    <ghg:isCompressionEquipmentDownStreamIndicator>Y</ghg:isCompressionEquipmentDownStreamIndicator>
    <ghg:isOtherProcessingEquipmentUpStreamIndicator>Y</ghg:isOtherProcessingEquipmentUpStreamIndicator>
    <ghg:isOtherProcessingEquipmentDownStreamIndicator>Y</ghg:isOtherProcessingEquipmentDownStreamIndicator>
    <ghg:OtherProcessingEquipmentDescription>Processing equipment description</ghg:OtherProcessingEquipmentDescription>
  </ghg:FlowMeterEquipmentLocationDetails>
  <ghg:VolumeDetails>
    <ghg:QuarterName>First Quarter</ghg:QuarterName>
    <ghg:VolumetricFlowofCO2>
      <ghg:MeasureValue>25</ghg:MeasureValue>
    </ghg:VolumetricFlowofCO2>
    <ghg:ConcentrationofCO2VolumePercent fractionUOM="fraction (number between 0 and 1)">
      <ghg:MeasureValue>0.554</ghg:MeasureValue>
    </ghg:ConcentrationofCO2VolumePercent>
    <ghg:DensityofCO2 densityUOM="mton/scm">
      <ghg:MeasureValue>0.0184</ghg:MeasureValue>
    </ghg:DensityofCO2>
  </ghg:VolumeDetails>
  <ghg:VolumeDetails>
    <ghg:QuarterName>Second Quarter</ghg:QuarterName>
    <ghg:VolumetricFlowofCO2>
      <ghg:MeasureValue>22</ghg:MeasureValue>
    </ghg:VolumetricFlowofCO2>
    <ghg:ConcentrationofCO2VolumePercent fractionUOM="fraction (number between 0 and 1)">
      <ghg:MeasureValue>0.654</ghg:MeasureValue>
    </ghg:ConcentrationofCO2VolumePercent>
    <ghg:DensityofCO2 densityUOM="mton/scm">
      <ghg:MeasureValue>0.0444</ghg:MeasureValue>
    </ghg:DensityofCO2>
  </ghg:VolumeDetails>
  <ghg:VolumeDetails>
    <ghg:QuarterName>Third Quarter</ghg:QuarterName>
    <ghg:VolumetricFlowofCO2>
      <ghg:MeasureValue>17</ghg:MeasureValue>
    </ghg:VolumetricFlowofCO2>
    <ghg:ConcentrationofCO2VolumePercent fractionUOM="fraction (number between 0 and 1)">
      <ghg:MeasureValue>0.224</ghg:MeasureValue>
    </ghg:ConcentrationofCO2VolumePercent>
    <ghg:DensityofCO2 densityUOM="mton/scm">

```

```

        <ghg:MeasureValue>0.0239</ghg:MeasureValue>
      </ghg:DensityofCO2>
    </ghg:VolumeDetails>
  </ghg:VolumeDetails>
  <ghg:VolumeDetails>
    <ghg:QuarterName>Fourth Quarter</ghg:QuarterName>
    <ghg:VolumetricFlowofCO2>
      <ghg:MeasureValue>75</ghg:MeasureValue>
    </ghg:VolumetricFlowofCO2>
    <ghg:ConcentrationofCO2VolumePercent fractionUOM="fraction (number between 0 and 1)">
      <ghg:MeasureValue>0.684</ghg:MeasureValue>
    </ghg:ConcentrationofCO2VolumePercent>
    <ghg:DensityofCO2 densityUOM="mton/scm">
      <ghg:MeasureValue>0.03376</ghg:MeasureValue>
    </ghg:DensityofCO2>
  </ghg:VolumeDetails>
</ghg:MeterDetails>
<ghg:MeterDetails>
  <ghg:UnitIdentification>
    <ghg:UnitName>Extract Stream</ghg:UnitName>
    <ghg:UnitDescription>Extract Flow Meter 1 and Stream Example</ghg:UnitDescription>
    <ghg:UnitType>CO2 Stream</ghg:UnitType>
  </ghg:UnitIdentification>
  <ghg:MassorVolume>Volumetric - concentration in volume percentage</ghg:MassorVolume>
  <ghg:AnnualMassofCO2 massUOM="Metric Tons">
    <ghg:MeasureValue>3.7</ghg:MeasureValue>
  </ghg:AnnualMassofCO2>
  <ghg:VolumeDetails>
    <ghg:QuarterName>First Quarter</ghg:QuarterName>
    <ghg:VolumetricFlowofCO2>
      <ghg:MeasureValue>1000</ghg:MeasureValue>
    </ghg:VolumetricFlowofCO2>
    <ghg:ConcentrationofCO2VolumePercent fractionUOM="fraction (number between 0 and 1)">
      <ghg:MeasureValue>0.5</ghg:MeasureValue>
    </ghg:ConcentrationofCO2VolumePercent>
    <ghg:DensityofCO2 densityUOM="mton/scm">
      <ghg:MeasureValue>0.001868</ghg:MeasureValue>
    </ghg:DensityofCO2>
  </ghg:VolumeDetails>
  <ghg:VolumeDetails>
    <ghg:QuarterName>Second Quarter</ghg:QuarterName>
    <ghg:VolumetricFlowofCO2>
      <ghg:MeasureValue>1000</ghg:MeasureValue>
    </ghg:VolumetricFlowofCO2>
    <ghg:ConcentrationofCO2VolumePercent fractionUOM="fraction (number between 0 and 1)">
      <ghg:MeasureValue>0.5</ghg:MeasureValue>
    </ghg:ConcentrationofCO2VolumePercent>
    <ghg:DensityofCO2 densityUOM="mton/scm">
      <ghg:MeasureValue>0.001868</ghg:MeasureValue>
    </ghg:DensityofCO2>
  </ghg:VolumeDetails>
  <ghg:VolumeDetails>
    <ghg:QuarterName>Third Quarter</ghg:QuarterName>
    <ghg:VolumetricFlowofCO2>
      <ghg:MeasureValue>1000</ghg:MeasureValue>
    </VolumetricFlowofCO2>
  </ghg:VolumeDetails>

```

```

        <ghg:ConcentrationofCO2VolumePercent fractionUOM="fraction (number between 0 and 1)">
          <ghg:MeasureValue>0.5</ghg:MeasureValue>
        </ghg:ConcentrationofCO2VolumePercent>
        <ghg:DensityofCO2 densityUOM="mton/scm">
          <ghg:MeasureValue>0.001868</ghg:MeasureValue>
        </ghg:DensityofCO2>
      </ghg:VolumeDetails>
    </ghg:VolumeDetails>
    <ghg:QuarterName>Fourth Quarter</ghg:QuarterName>
    <ghg:VolumetricFlowofCO2>
      <ghg:MeasureValue>1000</ghg:MeasureValue>
    </ghg:VolumetricFlowofCO2>
    <ghg:ConcentrationofCO2VolumePercent fractionUOM="fraction (number between 0 and 1)">
      <ghg:MeasureValue>0.5</ghg:MeasureValue>
    </ghg:ConcentrationofCO2VolumePercent>
    <ghg:DensityofCO2 densityUOM="mton/scm">
      <ghg:MeasureValue>0.001868</ghg:MeasureValue>
    </ghg:DensityofCO2>
  </ghg:VolumeDetails>
</ghg:MeterDetails>
<ghg:CO2EndUseDetails>
  <ghg:ApplicationName>Food and beverage</ghg:ApplicationName>
  <ghg:ImportExport>All</ghg:ImportExport>
  <ghg:QuantityofCO2 massUOM="Metric Tons">
    <ghg:MeasureValue>100.478</ghg:MeasureValue>
  </ghg:QuantityofCO2>
</ghg:CO2EndUseDetails>
<ghg:CO2EndUseDetails>
  <ghg:ApplicationName>Industrial and municipal water/wastewater treatment</ghg:ApplicationName>
  <ghg:ImportExport>All</ghg:ImportExport>
  <ghg:QuantityofCO2 massUOM="Metric Tons">
    <ghg:MeasureValue>200.278</ghg:MeasureValue>
  </ghg:QuantityofCO2>
</ghg:CO2EndUseDetails>
<ghg:CO2EndUseDetails>
  <ghg:ApplicationName>Metal fabrication, including welding and cutting</ghg:ApplicationName>
  <ghg:ImportExport>All</ghg:ImportExport>
  <ghg:QuantityofCO2 massUOM="Metric Tons">
    <ghg:MeasureValue>300.232</ghg:MeasureValue>
  </ghg:QuantityofCO2>
</ghg:CO2EndUseDetails>
<ghg:CO2EndUseDetails>
  <ghg:ApplicationName>Greenhouse uses for plant growth</ghg:ApplicationName>
  <ghg:ImportExport>All</ghg:ImportExport>
  <ghg:QuantityofCO2 massUOM="Metric Tons">
    <ghg:MeasureValue>400.78</ghg:MeasureValue>
  </ghg:QuantityofCO2>
</ghg:CO2EndUseDetails>
<ghg:CO2EndUseDetails>
  <ghg:ApplicationName>Fumigants (e.g., grain storage) and herbicides</ghg:ApplicationName>
  <ghg:ImportExport>All</ghg:ImportExport>
  <ghg:QuantityofCO2 massUOM="Metric Tons">
    <ghg:MeasureValue>500.234</ghg:MeasureValue>
  </ghg:QuantityofCO2>
</ghg:CO2EndUseDetails>

```

```

<ghg:CO2EndUseDetails>
  <ghg:ApplicationName>Pulp and paper</ghg:ApplicationName>
  <ghg:ImportExport>All</ghg:ImportExport>
  <ghg:QuantityofCO2 massUOM="Metric Tons">
    <ghg:MeasureValue>600.78</ghg:MeasureValue>
  </ghg:QuantityofCO2>
</ghg:CO2EndUseDetails>
<ghg:CO2EndUseDetails>
  <ghg:ApplicationName>Cleaning and solvent use</ghg:ApplicationName>
  <ghg:ImportExport>All</ghg:ImportExport>
  <ghg:QuantityofCO2 massUOM="Metric Tons">
    <ghg:MeasureValue>700.78</ghg:MeasureValue>
  </ghg:QuantityofCO2>
</ghg:CO2EndUseDetails>
<ghg:CO2EndUseDetails>
  <ghg:ApplicationName>Fire fighting</ghg:ApplicationName>
  <ghg:ImportExport>All</ghg:ImportExport>
  <ghg:QuantityofCO2 massUOM="Metric Tons">
    <ghg:MeasureValue>800.3698</ghg:MeasureValue>
  </ghg:QuantityofCO2>
</ghg:CO2EndUseDetails>
<ghg:CO2EndUseDetails>
  <ghg:ApplicationName>Transportation and storage of explosives</ghg:ApplicationName>
  <ghg:ImportExport>All</ghg:ImportExport>
  <ghg:QuantityofCO2 massUOM="Metric Tons">
    <ghg:MeasureValue>900.123</ghg:MeasureValue>
  </ghg:QuantityofCO2>
</ghg:CO2EndUseDetails>
<ghg:CO2EndUseDetails>
  <ghg:ApplicationName>Injection of CO2 for enhanced oil and natural gas recovery that is covered by 40 CFR Part 98, Subpart UU
  </ghg:ApplicationName>
  <ghg:ImportExport>All</ghg:ImportExport>
  <ghg:QuantityofCO2 massUOM="Metric Tons">
    <ghg:MeasureValue>1000.8979</ghg:MeasureValue>
  </ghg:QuantityofCO2>
</ghg:CO2EndUseDetails>
<ghg:CO2EndUseDetails>
  <ghg:ApplicationName>Geologic sequestration of carbon dioxide that is covered by 40 CFR Part 98, Subpart RR</ghg:ApplicationName>
  <ghg:ImportExport>All</ghg:ImportExport>
  <ghg:QuantityofCO2 massUOM="Metric Tons">
    <ghg:MeasureValue>1100.278</ghg:MeasureValue>
  </ghg:QuantityofCO2>
</ghg:CO2EndUseDetails>
<ghg:CO2EndUseDetails>
  <ghg:ApplicationName>Research and Development</ghg:ApplicationName>
  <ghg:ImportExport>All</ghg:ImportExport>
  <ghg:QuantityofCO2 massUOM="Metric Tons">
    <ghg:MeasureValue>1200.45</ghg:MeasureValue>
  </ghg:QuantityofCO2>
</ghg:CO2EndUseDetails>
<ghg:CO2EndUseDetails>
  <ghg:ApplicationName>Other</ghg:ApplicationName>
  <ghg:OtherApplicationName>Test Description</ghg:OtherApplicationName>
  <ghg:ImportExport>All</ghg:ImportExport>
  <ghg:QuantityofCO2 massUOM="Metric Tons">

```

```

    <ghg:MeasureValue>1300.33</ghg:MeasureValue>
  </ghg:QuantityofCO2>
</ghg:CO2EndUseDetails>
<ghg:EquipmentCalibrationDetails>
  <ghg:MeasuringEquipmentType>Volumetric flow meter</ghg:MeasuringEquipmentType>
</ghg:EquipmentCalibrationDetails>
<ghg:MassVolumeNumberofDaysSubstituted >1</ghg:MassVolumeNumberofDaysSubstituted>
<ghg:ConcentrationNumberofDaysSubstituted >2</ghg:ConcentrationNumberofDaysSubstituted >
<ghg:DensityNumberofDaysSubstituted>3</ghg:DensityNumberofDaysSubstituted>
</ghg:SubPartPP>
</ghg:SubPartInformation>
</ghg:FacilitySiteDetails>
<ghg:CalculationMethodologyChangesDescription/>
<ghg:BestAvailableMonitoringMethodsUsed/>
<ghg:StartDate>2013-01-01</ghg:StartDate>
<ghg:EndDate>2013-12-31</ghg:EndDate>
<ghg:DateTimeReportGenerated>2014-02-24T10:16:31</ghg:DateTimeReportGenerated>
</ghg:FacilitySiteInformation>
</ghg:GHG>
```

## 8.0 Extract Facility – Streams

### [98.423(b)]

*(Note: Data values do not reflect an actual facility's emissions. Additional sample XML files for Subpart PP are posted on the e-GGRT help site.)*

```
<ghg:GHG xmlns="http://www.ccdsupport.com/schema/ghg">
  <ghg:FacilitySiteInformation>
    <ghg:CertificationStatement>The designated representative or alternate designated representative must sign (i.e., agree to) this certification statement. If you are an agent and you click on "SUBMIT", you are not agreeing to the certification statement, but are submitting the certification statement on behalf of the designated representative or alternate designated representative who is agreeing to the certification statement. An agent is only authorized to make the electronic submission on behalf of the designated representative, not to sign (i.e., agree to) the certification statement.</ghg:CertificationStatement>
    <ghg:ReportingYear>2013</ghg:ReportingYear>
    <ghg:FacilitySiteDetails>
      <ghg:FacilitySite>
        <ghg:FacilitySiteIdentifier>524117</ghg:FacilitySiteIdentifier>
        <ghg:FacilitySiteName>Extract- Streams TEST Facility</ghg:FacilitySiteName>
      </ghg:FacilitySite>
      <ghg:LocationAddress>
        <ghg:LocationAddressText>12600 S. ANY STREET</ghg:LocationAddressText>
        <ghg:LocalityName>CHICAGO</ghg:LocalityName>
        <ghg:StateIdentity>
          <ghg:StateCode>IL</ghg:StateCode>
        </ghg:StateIdentity>
        <ghg:AddressPostalCode>60633</ghg:AddressPostalCode>
      </ghg:LocationAddress>
      <ghg:CogenerationUnitEmissionsIndicator>N</ghg:CogenerationUnitEmissionsIndicator>
      <ghg:PrimaryNAICSCode>325120</ghg:PrimaryNAICSCode>
      <ghg:ParentCompanyDetails>
        <ghg:ParentCompany>
          <ghg:ParentCompanyLegalName>Soda Ash Corporation</ghg:ParentCompanyLegalName>
          <ghg:StreetAddress>108 Hillcrest Street</ghg:StreetAddress>
          <ghg:City>Sandpoint</ghg:City>
          <ghg:State>ID</ghg:State>
          <ghg:Zip>83864</ghg:Zip>
          <ghg:PercentOwnershipInterest>100.0</ghg:PercentOwnershipInterest>
        </ghg:ParentCompany>
      </ghg:ParentCompanyDetails>
      <ghg:TotalNonBiogenicCO2eFacilitySubpartsCtoJJ massUOM="Metric Tons">0</ghg:TotalNonBiogenicCO2eFacilitySubpartsCtoJJ>
      <ghg:TotalBiogenicCO2FacilitySubpartsCtoJJ massUOM="Metric Tons">0</ghg:TotalBiogenicCO2FacilitySubpartsCtoJJ>
      <ghg:TotalCO2eSupplierSubpartsKktoPP massUOM="Metric Tons">131.2</ghg:TotalCO2eSupplierSubpartsKktoPP>
    </ghg:SubPartInformation>
    <ghg:SubPartPP>
      <ghg:GHGasInfoDetails>
        <ghg:GHGasName>Carbon Dioxide</ghg:GHGasName>
        <ghg:GHGasQuantity massUOM="Metric Tons">
          <ghg:CalculatedValue>131.2</ghg:CalculatedValue>
        </ghg:GHGasQuantity>
      </ghg:GHGasInfoDetails>
      <ghg:FacilityClassification>extract 98.420(a)(2)</ghg:FacilityClassification>
      <ghg:CalculationMethodology>Streams</ghg:CalculationMethodology>
      <ghg:MeterDetails>
```

```

<ghg:UnitIdentification>
  <ghg:UnitName>001- CO2 Stream </ghg:UnitName>
  <ghg:UnitDescription>CO2 stream #1 </ghg:UnitDescription>
  <ghg:UnitType>CO2 Stream </ghg:UnitType>
</ghg:UnitIdentification>
<ghg:MassorVolume>Volumetric - concentration in volume percentage</ghg:MassorVolume>
<ghg:AnnualMassofCO2 massUOM="Metric Tons">
  <ghg:MeasureValue>131.2</ghg:MeasureValue>
</ghg:AnnualMassofCO2>
<ghg:VolumeDetails>
  <ghg:QuarterName>First Quarter</ghg:QuarterName>
  <ghg:VolumetricFlowofCO2 volUOM="Standard Cubic Meters">
    <ghg:MeasureValue>10000.1</ghg:MeasureValue>
  </ghg:VolumetricFlowofCO2>
  <ghg:ConcentrationofCO2VolumePercent fractionUOM="fraction (number between 0 and 1)">
    <ghg:MeasureValue>0.545</ghg:MeasureValue>
  </ghg:ConcentrationofCO2VolumePercent>
  <ghg:StandardofMeasureforCO2>Standard F</ghg:StandardofMeasureforCO2>
  <ghg:DensityofCO2 densityUOM="mton/scm">
    <ghg:MeasureValue>0.001868</ghg:MeasureValue>
  </ghg:DensityofCO2>
  <ghg:MethodofMeasureforCO2Density>rule required density</ghg:MethodofMeasureforCO2Density>
</ghg:VolumeDetails>
<ghg:VolumeDetails>
  <ghg:QuarterName>Second Quarter</ghg:QuarterName>
  <ghg:VolumetricFlowofCO2 volUOM="Standard Cubic Meters">
    <ghg:MeasureValue>20000.2</ghg:MeasureValue>
  </ghg:VolumetricFlowofCO2>
  <ghg:ConcentrationofCO2VolumePercent fractionUOM="fraction (number between 0 and 1)">
    <ghg:MeasureValue>0.645</ghg:MeasureValue>
  </ghg:ConcentrationofCO2VolumePercent>
  <ghg:StandardofMeasureforCO2>Standard F</ghg:StandardofMeasureforCO2>
  <ghg:DensityofCO2 densityUOM="mton/scm">
    <ghg:MeasureValue>0.001868</ghg:MeasureValue>
  </ghg:DensityofCO2>
  <ghg:MethodofMeasureforCO2Density>rule required density</ghg:MethodofMeasureforCO2Density>
</ghg:VolumeDetails>
<ghg:VolumeDetails>
  <ghg:QuarterName>Third Quarter</ghg:QuarterName>
  <ghg:VolumetricFlowofCO2 volUOM="Standard Cubic Meters">
    <ghg:MeasureValue>30000.456</ghg:MeasureValue>
  </ghg:VolumetricFlowofCO2>
  <ghg:ConcentrationofCO2VolumePercent fractionUOM="fraction (number between 0 and 1)">
    <ghg:MeasureValue>0.7</ghg:MeasureValue>
  </ghg:ConcentrationofCO2VolumePercent>
  <ghg:StandardofMeasureforCO2>Standard F</ghg:StandardofMeasureforCO2>
  <ghg:DensityofCO2 densityUOM="mton/scm">
    <ghg:MeasureValue>0.001868</ghg:MeasureValue>
  </ghg:DensityofCO2>
  <ghg:MethodofMeasureforCO2Density>rule required density</ghg:MethodofMeasureforCO2Density>
</ghg:VolumeDetails>
<ghg:VolumeDetails>
  <ghg:QuarterName>Fourth Quarter</ghg:QuarterName>
  <ghg:VolumetricFlowofCO2 volUOM="Standard Cubic Meters">

```



```

        <ghg:MeasureValue>40000.789</ghg:MeasureValue>
      </ghg:VolumeFlowofCO2>
      <ghg:ConcentrationofCO2VolumePercent fractionUOM="fraction (number between 0 and 1)">
        <ghg:MeasureValue>0.8</ghg:MeasureValue>
      </ghg:ConcentrationofCO2VolumePercent>
      <ghg:StandardofMeasureforCO2>Standard F</ghg:StandardofMeasureforCO2>
      <ghg:DensityofCO2 densityUOM="mton/scm">
        <ghg:MeasureValue>0.001868</ghg:MeasureValue>
      </ghg:DensityofCO2>
      <ghg:MethodofMeasureforCO2Density>rule required density</ghg:MethodofMeasureforCO2Density>
    </ghg:VolumeDetails>
  </ghg:MeterDetails>
  <ghg:CO2EndUseDetails>
    <ghg:ApplicationName>Food and beverage</ghg:ApplicationName>
    <ghg:ImportExport>All</ghg:ImportExport>
    <ghg:QuantityofCO2 massUOM="Metric Tons">
      <ghg:MeasureValue>100.123</ghg:MeasureValue>
    </ghg:QuantityofCO2>
  </ghg:CO2EndUseDetails>
  <ghg:CO2EndUseDetails>
    <ghg:ApplicationName>Industrial and municipal water/wastewater treatment</ghg:ApplicationName>
    <ghg:ImportExport>All</ghg:ImportExport>
    <ghg:QuantityofCO2 massUOM="Metric Tons">
      <ghg:MeasureValue>200.45</ghg:MeasureValue>
    </ghg:QuantityofCO2>
  </ghg:CO2EndUseDetails>
  <ghg:CO2EndUseDetails>
    <ghg:ApplicationName>Metal fabrication, including welding and cutting</ghg:ApplicationName>
    <ghg:ImportExport>All</ghg:ImportExport>
    <ghg:QuantityofCO2 massUOM="Metric Tons">
      <ghg:MeasureValue>300.3453455</ghg:MeasureValue>
    </ghg:QuantityofCO2>
  </ghg:CO2EndUseDetails>
  <ghg:CO2EndUseDetails>
    <ghg:ApplicationName>Greenhouse uses for plant growth</ghg:ApplicationName>
    <ghg:ImportExport>All</ghg:ImportExport>
    <ghg:QuantityofCO2 massUOM="Metric Tons">
      <ghg:MeasureValue>400.145</ghg:MeasureValue>
    </ghg:QuantityofCO2>
  </ghg:CO2EndUseDetails>
  <ghg:CO2EndUseDetails>
    <ghg:ApplicationName>Fumigants (e.g., grain storage) and herbicides</ghg:ApplicationName>
    <ghg:ImportExport>All</ghg:ImportExport>
    <ghg:QuantityofCO2 massUOM="Metric Tons">
      <ghg:MeasureValue>500.345</ghg:MeasureValue>
    </ghg:QuantityofCO2>
  </ghg:CO2EndUseDetails>
  <ghg:CO2EndUseDetails>
    <ghg:ApplicationName>Pulp and paper</ghg:ApplicationName>
    <ghg:ImportExport>All</ghg:ImportExport>
    <ghg:QuantityofCO2 massUOM="Metric Tons">
      <ghg:MeasureValue>600.445</ghg:MeasureValue>
    </ghg:QuantityofCO2>
  </ghg:CO2EndUseDetails>
  <ghg:CO2EndUseDetails>

```

```

    <ghg:ApplicationName>Cleaning and solvent use</ghg:ApplicationName>
    <ghg:ImportExport>All</ghg:ImportExport>
    <ghg:QuantityofCO2 massUOM="Metric Tons">
      <ghg:MeasureValue>700.45</ghg:MeasureValue>
    </ghg:QuantityofCO2>
  </ghg:CO2EndUseDetails>
  <ghg:CO2EndUseDetails>
    <ghg:ApplicationName>Fire fighting</ghg:ApplicationName>
    <ghg:ImportExport>All</ghg:ImportExport>
    <ghg:QuantityofCO2 massUOM="Metric Tons">
      <ghg:MeasureValue>800.45</ghg:MeasureValue>
    </ghg:QuantityofCO2>
  </ghg:CO2EndUseDetails>
  <ghg:CO2EndUseDetails>
    <ghg:ApplicationName>Transportation and storage of explosives</ghg:ApplicationName>
    <ghg:ImportExport>All</ghg:ImportExport>
    <ghg:QuantityofCO2 massUOM="Metric Tons">
      <ghg:MeasureValue>900.45</ghg:MeasureValue>
    </ghg:QuantityofCO2>
  </ghg:CO2EndUseDetails>
  <ghg:CO2EndUseDetails>
    <ghg:ApplicationName>Injection of CO2 for enhanced oil and natural gas recovery that is covered by 40 CFR Part 98, Subpart UU
    </ghg:ApplicationName>
    <ghg:ImportExport>All</ghg:ImportExport>
    <ghg:QuantityofCO2 massUOM="Metric Tons">
      <ghg:MeasureValue>1000.5678</ghg:MeasureValue>
    </ghg:QuantityofCO2>
  </ghg:CO2EndUseDetails>
  <ghg:CO2EndUseDetails>
    <ghg:ApplicationName>Geologic sequestration of carbon dioxide that is covered by 40 CFR Part 98, Subpart RR</ghg:ApplicationName>
    <ghg:ImportExport>All</ghg:ImportExport>
    <ghg:QuantityofCO2 massUOM="Metric Tons">
      <ghg:MeasureValue>1100.45</ghg:MeasureValue>
    </ghg:QuantityofCO2>
  </ghg:CO2EndUseDetails>
  <ghg:CO2EndUseDetails>
    <ghg:ApplicationName>Research and Development</ghg:ApplicationName>
    <ghg:ImportExport>All</ghg:ImportExport>
    <ghg:QuantityofCO2 massUOM="Metric Tons">
      <ghg:MeasureValue>1200.7896</ghg:MeasureValue>
    </ghg:QuantityofCO2>
  </ghg:CO2EndUseDetails>
  <ghg:CO2EndUseDetails>
    <ghg:ApplicationName>Other</ghg:ApplicationName>
    <ghg:OtherApplicationName>Test Description</ghg:OtherApplicationName>
    <ghg:ImportExport>All</ghg:ImportExport>
    <ghg:QuantityofCO2 massUOM="Metric Tons">
      <ghg:MeasureValue>1300.45</ghg:MeasureValue>
    </ghg:QuantityofCO2>
  </ghg:CO2EndUseDetails>
  <ghg:EquipmentCalibrationDetails>
    <ghg:MeasuringEquipmentType>Mass flow meter</ghg:MeasuringEquipmentType>
    <ghg:StandardForCalibration>Standard A</ghg:StandardForCalibration>
  </ghg:EquipmentCalibrationDetails>
  <ghg:MassVolumeNumberofDaysSubstituted>1</ghg:MassVolumeNumberofDaysSubstituted>

```

```
<ghg:ConcentrationNumberofDaysSubstituted>2</ghg:ConcentrationNumberofDaysSubstituted>
<ghg:DensityNumberofDaysSubstituted>3</ghg:DensityNumberofDaysSubstituted>
</ghg:SubPartPP>
</ghg:SubPartInformation>
</ghg:FacilitySiteDetails>
<ghg:CalculationMethodologyChangesDescription/>
<ghg:BestAvailableMonitoringMethodsUsed/>
<ghg:StartDate>2013-01-01</ghg:StartDate>
<ghg:EndDate>2013-12-31</ghg:EndDate>
<ghg:DateTimeReportGenerated>2014-02-24T10:16:31</ghg:DateTimeReportGenerated>
</ghg:FacilitySiteInformation>
</ghg:GHG>
```

## 9.0 Import/Export – Flow Meters 3

*(Note: Data values do not reflect an actual facility's emissions. Additional sample XML files for Subpart PP are posted on the e-GGRT help site.)*

```

<ghg:GHG xmlns="http://www.ccdsupport.com/schema/ghg">
  <ghg:FacilitySiteInformation>
    <ghg:CertificationStatement>The designated representative or alternate designated representative must sign (i.e., agree to) this certification statement. If you are an agent and you click on "SUBMIT", you are not agreeing to the certification statement, but are submitting the certification statement on behalf of the designated representative or alternate designated representative who is agreeing to the certification statement. An agent is only authorized to make the electronic submission on behalf of the designated representative, not to sign (i.e., agree to) the certification statement. </ghg:CertificationStatement>
    <ghg:ReportingYear>2013</ghg:ReportingYear>
    <ghg:FacilitySiteDetails>
      <ghg:FacilitySite>
        <ghg:FacilitySiteIdentifier>524117</ghg:FacilitySiteIdentifier>
        <ghg:FacilitySiteName>Import/Export- Flow Meters 3 TEST Facility</ghg:FacilitySiteName>
      </ghg:FacilitySite>
      <ghg:LocationAddress>
        <ghg:LocationAddressText>12600 S. ANY STREET</ghg:LocationAddressText>
        <ghg:LocalityName>CHICAGO</ghg:LocalityName>
        <ghg:StateIdentity>
          <ghg:StateCode>IL</ghg:StateCode>
        </ghg:StateIdentity>
        <ghg:AddressPostalCode>60633</ghg:AddressPostalCode>
      </ghg:LocationAddress>
      <ghg:CogenerationUnitEmissionsIndicator>N</ghg:CogenerationUnitEmissionsIndicator>
      <ghg:PrimaryNAICSCode>325120</ghg:PrimaryNAICSCode>
      <ghg:ParentCompanyDetails>
        <ghg:ParentCompany>
          <ghg:ParentCompanyLegalName>Soda Ash Corporation</ghg:ParentCompanyLegalName>
          <ghg:StreetAddress>108 Hillcrest Street</ghg:StreetAddress>
          <ghg:City>Sandpoint</ghg:City>
          <ghg:State>ID</ghg:State>
          <ghg:Zip>83864</ghg:Zip>
          <ghg:PercentOwnershipInterest>100.0</ghg:PercentOwnershipInterest>
        </ghg:ParentCompany>
      </ghg:ParentCompanyDetails>
      <ghg:TotalNonBiogenicCO2eFacilitySubpartsCtoJJ massUOM="Metric Tons">0</ghg:TotalNonBiogenicCO2eFacilitySubpartsCtoJJ>
      <ghg:TotalBiogenicCO2FacilitySubpartsCtoJJ massUOM="Metric Tons">0</ghg:TotalBiogenicCO2FacilitySubpartsCtoJJ>
      <ghg:TotalCO2eSupplierSubpartsKKtoPP massUOM="Metric Tons">2365.9</ghg:TotalCO2eSupplierSubpartsKKtoPP>
    </ghg:SubPartInformation>
    <ghg:SubPartPP>
      <ghg:GHGasInfoDetails>
        <ghg:GHGasName>Carbon Dioxide</ghg:GHGasName>
        <ghg:GHGasQuantity massUOM="Metric Tons">
          <ghg:CalculatedValue>2365.9</ghg:CalculatedValue>
        </ghg:GHGasQuantity>
      </ghg:GHGasInfoDetails>
      <ghg:FacilityClassification>import/export 98.420(a)(3)</ghg:FacilityClassification>
      <ghg:CalculationMethodology>Flow Meters 3</ghg:CalculationMethodology>
      <ghg:ImporterExporterType>Importer</ghg:ImporterExporterType>
      <ghg:MeterDetails>
        <ghg:UnitIdentification>

```

```

    <ghg:UnitName>001- IFM </ghg:UnitName>
    <ghg:UnitDescription>import flow meter</ghg:UnitDescription>
    <ghg:UnitType>CO2 Flow Meter</ghg:UnitType>
  </ghg:UnitIdentification>
  <ghg:MassorVolume>Volumetric - concentration in volume percentage</ghg:MassorVolume>
  <ghg:AnnualMassofCO2 massUOM="Metric Tons">
    <ghg:MeasureValue>95.5</ghg:MeasureValue>
  </ghg:AnnualMassofCO2>
  <ghg:MeterImportExport>Import</ghg:MeterImportExport>
  <ghg:FlowMeterEquipmentLocationDetails>
    <ghg:isDehydrationEquipmentUpStreamIndicator>N</ghg:isDehydrationEquipmentUpStreamIndicator>
    <ghg:isDehydrationEquipmentDownStreamIndicator>Y</ghg:isDehydrationEquipmentDownStreamIndicator>
    <ghg:isCompressionEquipmentUpStreamIndicator>N</ghg:isCompressionEquipmentUpStreamIndicator>
    <ghg:isCompressionEquipmentDownStreamIndicator>Y</ghg:isCompressionEquipmentDownStreamIndicator>
    <ghg:isOtherProcessingEquipmentUpStreamIndicator>N</ghg:isOtherProcessingEquipmentUpStreamIndicator>
    <ghg:isOtherProcessingEquipmentDownStreamIndicator>Y</ghg:isOtherProcessingEquipmentDownStreamIndicator>
    <ghg:OtherProcessingEquipmentDescription>Processing equipment description</ghg:OtherProcessingEquipmentDescription>
  </ghg:FlowMeterEquipmentLocationDetails>
  <ghg:VolumeDetails>
    <ghg:QuarterName>First Quarter</ghg:QuarterName>
    <ghg:VolumetricFlowofCO2 volUOM="Standard Cubic Meters">
      <ghg:MeasureValue>10000.345</ghg:MeasureValue>
    </ghg:VolumetricFlowofCO2>
    <ghg:ConcentrationofCO2VolumePercent fractionUOM="fraction (number between 0 and 1)">
      <ghg:MeasureValue>0.5</ghg:MeasureValue>
    </ghg:ConcentrationofCO2VolumePercent>
    <ghg:StandardofMeasureforCO2>Standard L</ghg:StandardofMeasureforCO2>
    <ghg:DensityofCO2 densityUOM="mton/scm">
      <ghg:MeasureValue>0.001868</ghg:MeasureValue>
    </ghg:DensityofCO2>
    <ghg:MethodofMeasureforCO2Density>rule required density</ghg:MethodofMeasureforCO2Density>
  </ghg:VolumeDetails>
  <ghg:VolumeDetails>
    <ghg:QuarterName>Second Quarter</ghg:QuarterName>
    <ghg:VolumetricFlowofCO2 volUOM="Standard Cubic Meters">
      <ghg:MeasureValue>20000.45</ghg:MeasureValue>
    </ghg:VolumetricFlowofCO2>
    <ghg:ConcentrationofCO2VolumePercent fractionUOM="fraction (number between 0 and 1)">
      <ghg:MeasureValue>0.678</ghg:MeasureValue>
    </ghg:ConcentrationofCO2VolumePercent>
    <ghg:StandardofMeasureforCO2>Standard L</ghg:StandardofMeasureforCO2>
    <ghg:DensityofCO2 densityUOM="mton/scm">
      <ghg:MeasureValue>0.001868</ghg:MeasureValue>
    </ghg:DensityofCO2>
    <ghg:MethodofMeasureforCO2Density>rule required density</ghg:MethodofMeasureforCO2Density>
  </ghg:VolumeDetails>
  <ghg:VolumeDetails>
    <ghg:QuarterName>Third Quarter</ghg:QuarterName>
    <ghg:VolumetricFlowofCO2 volUOM="Standard Cubic Meters">
      <ghg:MeasureValue>3000.1230</ghg:MeasureValue>
    </ghg:VolumetricFlowofCO2>
    <ghg:ConcentrationofCO2VolumePercent fractionUOM="fraction (number between 0 and 1)">
      <ghg:MeasureValue>0.7</ghg:MeasureValue>
    </ghg:ConcentrationofCO2VolumePercent>
    <ghg:StandardofMeasureforCO2>Standard L</ghg:StandardofMeasureforCO2>
  </ghg:VolumeDetails>

```

```

        <ghg:DensityofCO2 densityUOM="mton/scm">
          <ghg:MeasureValue>0.001868</ghg:MeasureValue>
        </ghg:DensityofCO2 >
        <ghg:MethodofMeasureforCO2Density>rule required density </ghg:MethodofMeasureforCO2Density >
      </ghg:VolumeDetails >
    <ghg:VolumeDetails >
      <ghg:QuarterName>Fourth Quarter</ghg:QuarterName >
      <ghg:VolumetricFlowofCO2 volUOM="Standard Cubic Meters">
        <ghg:MeasureValue>40000.907</ghg:MeasureValue >
      </ghg:VolumetricFlowofCO2 >
      <ghg:ConcentrationofCO2VolumePercent fractionUOM="fraction (number between 0 and 1)">
        <ghg:MeasureValue>0.878</ghg:MeasureValue >
      </ghg:ConcentrationofCO2VolumePercent >
      <ghg:StandardofMeasureforCO2 >Standard L</ghg:StandardofMeasureforCO2 >
      <ghg:DensityofCO2 densityUOM="mton/scm">
        <ghg:MeasureValue>0.001868</ghg:MeasureValue >
      </ghg:DensityofCO2 >
      <ghg:MethodofMeasureforCO2Density>rule required density </ghg:MethodofMeasureforCO2Density >
    </ghg:VolumeDetails >
  </ghg:MeterDetails >
<ghg:MeterDetails >
  <ghg:UnitIdentification >
    <ghg:UnitName>002- EFM</ghg:UnitName >
    <ghg:UnitDescription >export flow meter</ghg:UnitDescription >
    <ghg:UnitType >CO2 Flow Meter</ghg:UnitType >
  </ghg:UnitIdentification >
  <ghg:MassorVolume>Volumetric - concentration in weight percentage</ghg:MassorVolume >
  <ghg:AnnualMassofCO2 massUOM="Metric Tons">
    <ghg:MeasureValue>2270.4</ghg:MeasureValue >
  </ghg:AnnualMassofCO2 >
  <ghg:MeterImportExport >Export</ghg:MeterImportExport >
  <ghg:FlowMeterEquipmentLocationDetails >
    <ghg:isDehydrationEquipmentUpStreamIndicator >N</ghg:isDehydrationEquipmentUpStreamIndicator >
    <ghg:isDehydrationEquipmentDownStreamIndicator >Y</ghg:isDehydrationEquipmentDownStreamIndicator >
    <ghg:isCompressionEquipmentUpStreamIndicator >N</ghg:isCompressionEquipmentUpStreamIndicator >
    <ghg:isCompressionEquipmentDownStreamIndicator >Y</ghg:isCompressionEquipmentDownStreamIndicator >
    <ghg:isOtherProcessingEquipmentUpStreamIndicator >N</ghg:isOtherProcessingEquipmentUpStreamIndicator >
    <ghg:isOtherProcessingEquipmentDownStreamIndicator >Y</ghg:isOtherProcessingEquipmentDownStreamIndicator >
    <ghg:OtherProcessingEquipmentDescription >Processing equipment description</ghg:OtherProcessingEquipmentDescription >
  </ghg:FlowMeterEquipmentLocationDetails >
  <ghg:VolumeDetails >
    <ghg:QuarterName>First Quarter</ghg:QuarterName >
    <ghg:VolumetricFlowofCO2 volUOM="Standard Cubic Meters">
      <ghg:MeasureValue>1100.678</ghg:MeasureValue >
    </ghg:VolumetricFlowofCO2 >
    <ghg:ConcentrationofCO2WeightPercent fractionUOM="fraction (number between 0 and 1)">
      <ghg:MeasureValue>0.578</ghg:MeasureValue >
    </ghg:ConcentrationofCO2WeightPercent >
    <ghg:StandardofMeasureforCO2 >Standard N</ghg:StandardofMeasureforCO2 >
    <ghg:DensityofCO2 densityUOM="mton/scm">
      <ghg:MeasureValue>0.178</ghg:MeasureValue >
    </ghg:DensityofCO2 >
    <ghg:MethodofMeasureforCO2Density >Standard M</ghg:MethodofMeasureforCO2Density >
  </ghg:VolumeDetails >
</ghg:VolumeDetails >

```

```

    <ghg:QuarterName>Second Quarter</ghg:QuarterName>
    <ghg:VolumetricFlowofCO2 volUOM="Standard Cubic Meters">
      <ghg:MeasureValue>2100.67</ghg:MeasureValue>
    </ghg:VolumetricFlowofCO2>
    <ghg:ConcentrationofCO2WeightPercent fractionUOM="fraction (number between 0 and 1)">
      <ghg:MeasureValue>0.678</ghg:MeasureValue>
    </ghg:ConcentrationofCO2WeightPercent>
    <ghg:StandardofMeasureforCO2>Standard N</ghg:StandardofMeasureforCO2>
    <ghg:DensityofCO2 densityUOM="mton/scm">
      <ghg:MeasureValue>0.278</ghg:MeasureValue>
    </ghg:DensityofCO2>
    <ghg:MethodofMeasureforCO2Density>Standard M</ghg:MethodofMeasureforCO2Density>
  </ghg:VolumeDetails>
<ghg:VolumeDetails>
<ghg:QuarterName>Third Quarter</ghg:QuarterName>
  <ghg:VolumetricFlowofCO2 volUOM="Standard Cubic Meters">
    <ghg:MeasureValue>3100.565</ghg:MeasureValue>
  </ghg:VolumetricFlowofCO2>
  <ghg:ConcentrationofCO2WeightPercent fractionUOM="fraction (number between 0 and 1)">
    <ghg:MeasureValue>0.778</ghg:MeasureValue>
  </ghg:ConcentrationofCO2WeightPercent>
  <ghg:StandardofMeasureforCO2>Standard N</ghg:StandardofMeasureforCO2>
  <ghg:DensityofCO2 densityUOM="mton/scm">
    <ghg:MeasureValue>0.378</ghg:MeasureValue>
  </ghg:DensityofCO2>
  <ghg:MethodofMeasureforCO2Density>Standard M</ghg:MethodofMeasureforCO2Density>
</ghg:VolumeDetails>
<ghg:VolumeDetails>
<ghg:QuarterName>Fourth Quarter</ghg:QuarterName>
  <ghg:VolumetricFlowofCO2 volUOM="Standard Cubic Meters">
    <ghg:MeasureValue>4100.456</ghg:MeasureValue>
  </ghg:VolumetricFlowofCO2>
  <ghg:ConcentrationofCO2WeightPercent fractionUOM="fraction (number between 0 and 1)">
    <ghg:MeasureValue>0.878</ghg:MeasureValue>
  </ghg:ConcentrationofCO2WeightPercent>
  <ghg:StandardofMeasureforCO2>Standard N</ghg:StandardofMeasureforCO2>
  <ghg:DensityofCO2 densityUOM="mton/scm">
    <ghg:MeasureValue>0.478</ghg:MeasureValue>
  </ghg:DensityofCO2>
  <ghg:MethodofMeasureforCO2Density>Standard M</ghg:MethodofMeasureforCO2Density>
</ghg:VolumeDetails>
</ghg:MeterDetails>
<ghg:CO2EndUseDetails>
  <ghg:ApplicationName>Food and beverage</ghg:ApplicationName>
  <ghg:ImportExport>Import</ghg:ImportExport>
  <ghg:QuantityofCO2 massUOM="Metric Tons">
    <ghg:MeasureValue>100.2524567</ghg:MeasureValue>
  </ghg:QuantityofCO2>
</ghg:CO2EndUseDetails>
<ghg:CO2EndUseDetails>
  <ghg:ApplicationName>Industrial and municipal water/wastewater treatment</ghg:ApplicationName>
  <ghg:ImportExport>Import</ghg:ImportExport>
  <ghg:QuantityofCO2 massUOM="Metric Tons">
    <ghg:MeasureValue>200.5654656</ghg:MeasureValue>
  </ghg:QuantityofCO2>

```

```

</ghg:CO2EndUseDetails>
<ghg:CO2EndUseDetails>
  <ghg:ApplicationName>Metal fabrication, including welding and cutting </ghg:ApplicationName>
  <ghg:ImportExport>Import </ghg:ImportExport>
  <ghg:QuantityofCO2 massUOM="Metric Tons">
    <ghg:MeasureValue>300.333879</ghg:MeasureValue>
  </ghg:QuantityofCO2>
</ghg:CO2EndUseDetails>
<ghg:CO2EndUseDetails>
  <ghg:ApplicationName>Greenhouse uses for plant growth</ghg:ApplicationName>
  <ghg:ImportExport>Import </ghg:ImportExport>
  <ghg:QuantityofCO2 massUOM="Metric Tons">
    <ghg:MeasureValue>400.35368</ghg:MeasureValue>
  </ghg:QuantityofCO2>
</ghg:CO2EndUseDetails>
<ghg:CO2EndUseDetails>
  <ghg:ApplicationName>Fumigants (e.g., grain storage) and herbicides </ghg:ApplicationName>
  <ghg:ImportExport>Import </ghg:ImportExport>
  <ghg:QuantityofCO2 massUOM="Metric Tons">
    <ghg:MeasureValue>500.208977</ghg:MeasureValue>
  </ghg:QuantityofCO2>
</ghg:CO2EndUseDetails>
<ghg:CO2EndUseDetails>
  <ghg:ApplicationName>Pulp and paper </ghg:ApplicationName>
  <ghg:ImportExport>Import </ghg:ImportExport>
  <ghg:QuantityofCO2 massUOM="Metric Tons">
    <ghg:MeasureValue>600.23426</ghg:MeasureValue>
  </ghg:QuantityofCO2>
</ghg:CO2EndUseDetails>
<ghg:CO2EndUseDetails>
  <ghg:ApplicationName>Cleaning and solvent use </ghg:ApplicationName>
  <ghg:ImportExport>Import </ghg:ImportExport>
  <ghg:QuantityofCO2 massUOM="Metric Tons">
    <ghg:MeasureValue>700.22246</ghg:MeasureValue>
  </ghg:QuantityofCO2>
</ghg:CO2EndUseDetails>
<ghg:CO2EndUseDetails>
  <ghg:ApplicationName>Fire fighting </ghg:ApplicationName>
  <ghg:ImportExport>Import </ghg:ImportExport>
  <ghg:QuantityofCO2 massUOM="Metric Tons">
    <ghg:MeasureValue>800.9793223</ghg:MeasureValue>
  </ghg:QuantityofCO2>
</ghg:CO2EndUseDetails>
<ghg:CO2EndUseDetails>
  <ghg:ApplicationName>Transportation and storage of explosives </ghg:ApplicationName>
  <ghg:ImportExport>Import </ghg:ImportExport>
  <ghg:QuantityofCO2 massUOM="Metric Tons">
    <ghg:MeasureValue>9890.323442346</ghg:MeasureValue>
  </ghg:QuantityofCO2>
</ghg:CO2EndUseDetails>
<ghg:CO2EndUseDetails>
  <ghg:ApplicationName>Injection of CO2 for enhanced oil and natural gas recovery that is covered by 40 CFR Part 98, Subpart UU
  </ghg:ApplicationName>
  <ghg:ImportExport>Import </ghg:ImportExport>
  <ghg:QuantityofCO2 massUOM="Metric Tons">

```



```

        <ghg:MeasureValue>10100.45623</ghg:MeasureValue >
      </ghg:QuantityofCO2>
    </ghg:CO2EndUseDetails >
  <ghg:CO2EndUseDetails>
    <ghg:ApplicationName>Geologic sequestration of carbon dioxide that is covered by 40 CFR Part 98, Subpart RR</ghg:ApplicationName>
    <ghg:ImportExport>Import</ghg:ImportExport>
    <ghg:QuantityofCO2 massUOM="Metric Tons">
      <ghg:MeasureValue>1100.32342</ghg:MeasureValue>
    </ghg:QuantityofCO2>
  </ghg:CO2EndUseDetails >
<ghg:CO2EndUseDetails>
  <ghg:ApplicationName>Research and Development</ghg:ApplicationName>
  <ghg:ImportExport>Import</ghg:ImportExport>
  <ghg:QuantityofCO2 massUOM="Metric Tons">
    <ghg:MeasureValue>1200.248723</ghg:MeasureValue >
  </ghg:QuantityofCO2>
</ghg:CO2EndUseDetails >
<ghg:CO2EndUseDetails>
  <ghg:ApplicationName>Other</ghg:ApplicationName>
  <ghg:OtherApplicationName>Test Description</ghg:OtherApplicationName>
  <ghg:ImportExport>Import</ghg:ImportExport>
  <ghg:QuantityofCO2 massUOM="Metric Tons">
    <ghg:MeasureValue>1300.23898</ghg:MeasureValue>
  </ghg:QuantityofCO2>
</ghg:CO2EndUseDetails >
<ghg:CO2EndUseDetails>
  <ghg:ApplicationName>Food and beverage</ghg:ApplicationName>
  <ghg:ImportExport>Export</ghg:ImportExport >
  <ghg:QuantityofCO2 massUOM="Metric Tons">
    <ghg:MeasureValue>1.234924</ghg:MeasureValue>
  </ghg:QuantityofCO2>
</ghg:CO2EndUseDetails >
<ghg:CO2EndUseDetails>
  <ghg:ApplicationName>Industrial and municipal water/wastewater treatment</ghg:ApplicationName>
  <ghg:ImportExport>Export</ghg:ImportExport >
  <ghg:QuantityofCO2 massUOM="Metric Tons">
    <ghg:MeasureValue>2.23473</ghg:MeasureValue>
  </ghg:QuantityofCO2>
</ghg:CO2EndUseDetails >
<ghg:CO2EndUseDetails>
  <ghg:ApplicationName>Metal fabrication, including welding and cutting</ghg:ApplicationName>
  <ghg:ImportExport>Export</ghg:ImportExport >
  <ghg:QuantityofCO2 massUOM="Metric Tons">
    <ghg:MeasureValue>3.234235</ghg:MeasureValue>
  </ghg:QuantityofCO2>
</ghg:CO2EndUseDetails >
<ghg:CO2EndUseDetails>
  <ghg:ApplicationName>Greenhouse uses for plant growth</ghg:ApplicationName>
  <ghg:ImportExport>Export</ghg:ImportExport >
  <ghg:QuantityofCO2 massUOM="Metric Tons">
    <ghg:MeasureValue>4.234213</ghg:MeasureValue>
  </ghg:QuantityofCO2>
</ghg:CO2EndUseDetails >
<ghg:CO2EndUseDetails>
  <ghg:ApplicationName>Fumigants (e.g., grain storage) and herbicides</ghg:ApplicationName>

```

```

    <ghg:ImportExport>Export</ghg:ImportExport>
    <ghg:QuantityofCO2 massUOM="Metric Tons">
      <ghg:MeasureValue>5.234283</ghg:MeasureValue>
    </ghg:QuantityofCO2>
  </ghg:CO2EndUseDetails>
  <ghg:CO2EndUseDetails>
    <ghg:ApplicationName>Pulp and paper</ghg:ApplicationName>
    <ghg:ImportExport>Export</ghg:ImportExport>
    <ghg:QuantityofCO2 massUOM="Metric Tons">
      <ghg:MeasureValue>6.234239</ghg:MeasureValue>
    </ghg:QuantityofCO2>
  </ghg:CO2EndUseDetails>
  <ghg:CO2EndUseDetails>
    <ghg:ApplicationName>Cleaning and solvent use</ghg:ApplicationName>
    <ghg:ImportExport>Export</ghg:ImportExport>
    <ghg:QuantityofCO2 massUOM="Metric Tons">
      <ghg:MeasureValue>7.23473</ghg:MeasureValue>
    </ghg:QuantityofCO2>
  </ghg:CO2EndUseDetails>
  <ghg:CO2EndUseDetails>
    <ghg:ApplicationName>Fire fighting</ghg:ApplicationName>
    <ghg:ImportExport>Export</ghg:ImportExport>
    <ghg:QuantityofCO2 massUOM="Metric Tons">
      <ghg:MeasureValue>8.2323</ghg:MeasureValue>
    </ghg:QuantityofCO2>
  </ghg:CO2EndUseDetails>
  <ghg:CO2EndUseDetails>
    <ghg:ApplicationName>Transportation and storage of explosives</ghg:ApplicationName>
    <ghg:ImportExport>Export</ghg:ImportExport>
    <ghg:QuantityofCO2 massUOM="Metric Tons">
      <ghg:MeasureValue>9.234</ghg:MeasureValue>
    </ghg:QuantityofCO2>
  </ghg:CO2EndUseDetails>
  <ghg:CO2EndUseDetails>
    <ghg:ApplicationName>Injection of CO2 for enhanced oil and natural gas recovery that is covered by 40 CFR Part 98, Subpart UU
    </ghg:ApplicationName>
    <ghg:ImportExport>Export</ghg:ImportExport>
    <ghg:QuantityofCO2 massUOM="Metric Tons">
      <ghg:MeasureValue>10.234</ghg:MeasureValue>
    </ghg:QuantityofCO2>
  </ghg:CO2EndUseDetails>
  <ghg:CO2EndUseDetails>
    <ghg:ApplicationName>Geologic sequestration of carbon dioxide that is covered by 40 CFR Part 98, Subpart RR</ghg:ApplicationName>
    <ghg:ImportExport>Export</ghg:ImportExport>
    <ghg:QuantityofCO2 massUOM="Metric Tons">
      <ghg:MeasureValue>11.377</ghg:MeasureValue>
    </ghg:QuantityofCO2>
  </ghg:CO2EndUseDetails>
  <ghg:CO2EndUseDetails>
    <ghg:ApplicationName>Research and Development</ghg:ApplicationName>
    <ghg:ImportExport>Export</ghg:ImportExport>
    <ghg:QuantityofCO2 massUOM="Metric Tons">
      <ghg:MeasureValue>12.23434</ghg:MeasureValue>
    </ghg:QuantityofCO2>
  </ghg:CO2EndUseDetails>

```

```
<ghg:CO2EndUseDetails>
  <ghg:ApplicationName>Other</ghg:ApplicationName>
  <ghg:OtherApplicationName>Test Description</ghg:OtherApplicationName>
  <ghg:ImportExport>Export</ghg:ImportExport>
  <ghg:QuantityofCO2massUOM="Metric Tons">
    <ghg:MeasureValue>13.12634</ghg:MeasureValue>
  </ghg:QuantityofCO2>
</ghg:CO2EndUseDetails>
<ghg:EquipmentCalibrationDetails>
  <ghg:MeasuringEquipmentType>Weigh bill</ghg:MeasuringEquipmentType>
  <ghg:StandardForCalibration>Standard B</ghg:StandardForCalibration>
</ghg:EquipmentCalibrationDetails>
<ghg:MassVolumeNumberofDaysSubstituted >1</ghg:MassVolumeNumberofDaysSubstituted>
<ghg:ConcentrationNumberofDaysSubstituted >2</ghg:ConcentrationNumberofDaysSubstituted>
<ghg:DensityNumberofDaysSubstituted>3</ghg:DensityNumberofDaysSubstituted>
</ghg:SubPartPP>
</ghg:SubPartInformation>
</ghg:FacilitySiteDetails>
<ghg:CalculationMethodologyChangesDescription/>
<ghg:BestAvailableMonitoringMethodsUsed/>
<ghg:StartDate>2013-01-01</ghg:StartDate>
<ghg:EndDate>2013-12-31</ghg:EndDate>
<ghg:DateTimeReportGenerated>2014-02-24T10:16:31</ghg:DateTimeReportGenerated>
</ghg:FacilitySiteInformation>
</ghg:GHG>
```

## 10.0 Import/Export – Containers

### [98.423(c)]

*(Note: Data values do not reflect an actual facility's emissions. Additional sample XML files for Subpart PP are posted on the e-GGRT help site.)*

```

<ghg:GHG xmlns="http://www.ccdsupport.com/schema/ghg">
  <ghg:FacilitySiteInformation>
    <ghg:CertificationStatement>The designated representative or alternate designated representative must sign (i.e., agree to) this certification statement. If you are an agent and you click on "SUBMIT", you are not agreeing to the certification statement, but are submitting the certification statement on behalf of the designated representative or alternate designated representative who is agreeing to the certification statement. An agent is only authorized to make the electronic submission on behalf of the designated representative, not to sign (i.e., agree to) the certification statement.</ghg:CertificationStatement>
    <ghg:ReportingYear>2013</ghg:ReportingYear>
    <ghg:FacilitySiteDetails>
      <ghg:FacilitySite>
        <ghg:FacilitySiteIdentifier>524117</ghg:FacilitySiteIdentifier>
        <ghg:FacilitySiteName>Import/Export- Containers TEST Facility</ghg:FacilitySiteName>
      </ghg:FacilitySite>
      <ghg:LocationAddress>
        <ghg:LocationAddressText>12600 S. ANY STREET</ghg:LocationAddressText>
        <ghg:LocalityName>CHICAGO</ghg:LocalityName>
        <ghg:StateIdentity>
          <ghg:StateCode>IL</ghg:StateCode>
        </ghg:StateIdentity>
        <ghg:AddressPostalCode>60633</ghg:AddressPostalCode>
      </ghg:LocationAddress>
      <ghg:CogenerationUnitEmissionsIndicator>N</ghg:CogenerationUnitEmissionsIndicator>
      <ghg:PrimaryNAICSCode>325120</ghg:PrimaryNAICSCode>
      <ghg:ParentCompanyDetails>
        <ghg:ParentCompany>
          <ghg:ParentCompanyLegalName>Soda Ash Corporation</ghg:ParentCompanyLegalName>
          <ghg:StreetAddress>108 Hillcrest Street</ghg:StreetAddress>
          <ghg:City>Sandpoint</ghg:City>
          <ghg:State>ID</ghg:State>
          <ghg:Zip>83864</ghg:Zip>
          <ghg:PercentOwnershipInterest>100.0</ghg:PercentOwnershipInterest>
        </ghg:ParentCompany>
      </ghg:ParentCompanyDetails>
      <ghg:TotalNonBiogenicCO2eFacilitySubpartsCtoJJ massUOM="Metric Tons">0</ghg:TotalNonBiogenicCO2eFacilitySubpartsCtoJJ>
      <ghg:TotalBiogenicCO2FacilitySubpartsCtoJJ massUOM="Metric Tons">0</ghg:TotalBiogenicCO2FacilitySubpartsCtoJJ>
      <ghg:TotalCO2eSupplierSubpartsKktoPP massUOM="Metric Tons">1350.2</ghg:TotalCO2eSupplierSubpartsKktoPP>
    </ghg:SubPartInformation>
    <ghg:SubPartPP>
      <ghg:GHGasInfoDetails>
        <ghg:GHGasName>Carbon Dioxide</ghg:GHGasName>
        <ghg:GHGasQuantity massUOM="Metric Tons">
          <ghg:CalculatedValue>1350.2</ghg:CalculatedValue>
        </ghg:GHGasQuantity>
      </ghg:GHGasInfoDetails>
      <ghg:FacilityClassification>import/export 98.420(a)(3)</ghg:FacilityClassification>
      <ghg:CalculationMethodology>Containers</ghg:CalculationMethodology>
      <ghg:ImporterExporterType>Importer</ghg:ImporterExporterType>
      <ghg:PP4CO2Details>
        <ghg:AnnualMassofCO2Imported massUOM="Metric Tons">

```

```

        <ghg:CalculatedValue>1500.6</ghg:CalculatedValue>
      </ghg:AnnualMassofCO2Imported>
      <ghg:AnnualMassofCO2Exported massUOM="Metric Tons">
        <ghg:CalculatedValue>150.4</ghg:CalculatedValue>
      </ghg:AnnualMassofCO2Exported>
    </ghg:PP4CO2Details>
  <ghg:CO2EndUseDetails>
    <ghg:ApplicationName>Food and beverage</ghg:ApplicationName>
    <ghg:ImportExport>Import</ghg:ImportExport>
    <ghg:QuantityofCO2 massUOM="Metric Tons">
      <ghg:MeasureValue>100.89</ghg:MeasureValue>
    </ghg:QuantityofCO2>
  </ghg:CO2EndUseDetails>
  <ghg:CO2EndUseDetails>
    <ghg:ApplicationName>Industrial and municipal water/wastewater treatment</ghg:ApplicationName>
    <ghg:ImportExport>Import</ghg:ImportExport>
    <ghg:QuantityofCO2 massUOM="Metric Tons">
      <ghg:MeasureValue>200.189</ghg:MeasureValue>
    </ghg:QuantityofCO2>
  </ghg:CO2EndUseDetails>
  <ghg:CO2EndUseDetails>
    <ghg:ApplicationName>Metal fabrication, including welding and cutting</ghg:ApplicationName>
    <ghg:ImportExport>Import</ghg:ImportExport>
    <ghg:QuantityofCO2 massUOM="Metric Tons">
      <ghg:MeasureValue>300.234</ghg:MeasureValue>
    </ghg:QuantityofCO2>
  </ghg:CO2EndUseDetails>
  <ghg:CO2EndUseDetails>
    <ghg:ApplicationName>Greenhouse uses for plant growth</ghg:ApplicationName>
    <ghg:ImportExport>Import</ghg:ImportExport>
    <ghg:QuantityofCO2 massUOM="Metric Tons">
      <ghg:MeasureValue>400.189</ghg:MeasureValue>
    </ghg:QuantityofCO2>
  </ghg:CO2EndUseDetails>
  <ghg:CO2EndUseDetails>
    <ghg:ApplicationName>Fumigants (e.g., grain storage) and herbicides</ghg:ApplicationName>
    <ghg:ImportExport>Import</ghg:ImportExport>
    <ghg:QuantityofCO2 massUOM="Metric Tons">
      <ghg:MeasureValue>500.389</ghg:MeasureValue>
    </ghg:QuantityofCO2>
  </ghg:CO2EndUseDetails>
  <ghg:CO2EndUseDetails>
    <ghg:ApplicationName>Pulp and paper</ghg:ApplicationName>
    <ghg:ImportExport>Import</ghg:ImportExport>
    <ghg:QuantityofCO2 massUOM="Metric Tons">
      <ghg:MeasureValue>600.89</ghg:MeasureValue>
    </ghg:QuantityofCO2>
  </ghg:CO2EndUseDetails>
  <ghg:CO2EndUseDetails>
    <ghg:ApplicationName>Cleaning and solvent use</ghg:ApplicationName>
    <ghg:ImportExport>Import</ghg:ImportExport>
    <ghg:QuantityofCO2 massUOM="Metric Tons">
      <ghg:MeasureValue>700.56</ghg:MeasureValue>
    </ghg:QuantityofCO2>
  </ghg:CO2EndUseDetails>

```

```

<ghg:CO2EndUseDetails>
  <ghg:ApplicationName>Fire fighting</ghg:ApplicationName>
  <ghg:ImportExport>Import</ghg:ImportExport>
  <ghg:QuantityofCO2 massUOM="Metric Tons">
    <ghg:MeasureValue>800.24</ghg:MeasureValue>
  </ghg:QuantityofCO2>
</ghg:CO2EndUseDetails>
<ghg:CO2EndUseDetails>
  <ghg:ApplicationName>Transportation and storage of explosives</ghg:ApplicationName>
  <ghg:ImportExport>Import</ghg:ImportExport>
  <ghg:QuantityofCO2 massUOM="Metric Tons">
    <ghg:MeasureValue>900.89</ghg:MeasureValue>
  </ghg:QuantityofCO2>
</ghg:CO2EndUseDetails>
<ghg:CO2EndUseDetails>
  <ghg:ApplicationName>Injection of CO2 for enhanced oil and natural gas recovery that is covered by 40 CFR Part 98, Subpart UU
  </ghg:ApplicationName>
  <ghg:ImportExport>Import</ghg:ImportExport>
  <ghg:QuantityofCO2 massUOM="Metric Tons">
    <ghg:MeasureValue>1000.354</ghg:MeasureValue>
  </ghg:QuantityofCO2>
</ghg:CO2EndUseDetails>
<ghg:CO2EndUseDetails>
  <ghg:ApplicationName>Geologic sequestration of carbon dioxide that is covered by 40 CFR Part 98, Subpart RR</ghg:ApplicationName>
  <ghg:ImportExport>Import</ghg:ImportExport>
  <ghg:QuantityofCO2 massUOM="Metric Tons">
    <ghg:MeasureValue>1100.28</ghg:MeasureValue>
  </ghg:QuantityofCO2>
</ghg:CO2EndUseDetails>
<ghg:CO2EndUseDetails>
  <ghg:ApplicationName>Research and Development</ghg:ApplicationName>
  <ghg:ImportExport>Import</ghg:ImportExport>
  <ghg:QuantityofCO2 massUOM="Metric Tons">
    <ghg:MeasureValue>1200.12</ghg:MeasureValue>
  </ghg:QuantityofCO2>
</ghg:CO2EndUseDetails>
<ghg:CO2EndUseDetails>
  <ghg:ApplicationName>Other</ghg:ApplicationName>
  <ghg:OtherApplicationName>Test Description</ghg:OtherApplicationName>
  <ghg:ImportExport>Import</ghg:ImportExport>
  <ghg:QuantityofCO2 massUOM="Metric Tons">
    <ghg:MeasureValue>1300.99</ghg:MeasureValue>
  </ghg:QuantityofCO2>
</ghg:CO2EndUseDetails>
<ghg:CO2EndUseDetails>
  <ghg:ApplicationName>Food and beverage</ghg:ApplicationName>
  <ghg:ImportExport>Export</ghg:ImportExport>
  <ghg:QuantityofCO2 massUOM="Metric Tons">
    <ghg:MeasureValue>1.189</ghg:MeasureValue>
  </ghg:QuantityofCO2>
</ghg:CO2EndUseDetails>
<ghg:CO2EndUseDetails>
  <ghg:ApplicationName>Industrial and municipal water/wastewater treatment</ghg:ApplicationName>
  <ghg:ImportExport>Export</ghg:ImportExport>
  <ghg:QuantityofCO2 massUOM="Metric Tons">

```

```

        <ghg:MeasureValue>2.189</ghg:MeasureValue>
      </ghg:QuantityofCO2>
    </ghg:CO2EndUseDetails>
  <ghg:CO2EndUseDetails>
    <ghg:ApplicationName>Metal fabrication, including welding and cutting </ghg:ApplicationName>
    <ghg:ImportExport>Export</ghg:ImportExport>
    <ghg:QuantityofCO2 massUOM="Metric Tons">
      <ghg:MeasureValue>3.189</ghg:MeasureValue>
    </ghg:QuantityofCO2>
  </ghg:CO2EndUseDetails>
  <ghg:CO2EndUseDetails>
    <ghg:ApplicationName>Greenhouse uses for plant growth</ghg:ApplicationName>
    <ghg:ImportExport>Export</ghg:ImportExport>
    <ghg:QuantityofCO2 massUOM="Metric Tons">
      <ghg:MeasureValue>4.789</ghg:MeasureValue>
    </ghg:QuantityofCO2>
  </ghg:CO2EndUseDetails>
  <ghg:CO2EndUseDetails>
    <ghg:ApplicationName>Fumigants (e.g., grain storage) and herbicides </ghg:ApplicationName>
    <ghg:ImportExport>Export</ghg:ImportExport>
    <ghg:QuantityofCO2 massUOM="Metric Tons">
      <ghg:MeasureValue>5.89</ghg:MeasureValue>
    </ghg:QuantityofCO2>
  </ghg:CO2EndUseDetails>
  <ghg:CO2EndUseDetails>
    <ghg:ApplicationName>Pulp and paper</ghg:ApplicationName>
    <ghg:ImportExport>Export</ghg:ImportExport>
    <ghg:QuantityofCO2 massUOM="Metric Tons">
      <ghg:MeasureValue>6.89</ghg:MeasureValue>
    </ghg:QuantityofCO2>
  </ghg:CO2EndUseDetails>
  <ghg:CO2EndUseDetails>
    <ghg:ApplicationName>Cleaning and solvent use</ghg:ApplicationName>
    <ghg:ImportExport>Export</ghg:ImportExport>
    <ghg:QuantityofCO2 massUOM="Metric Tons">
      <ghg:MeasureValue>7.789</ghg:MeasureValue>
    </ghg:QuantityofCO2>
  </ghg:CO2EndUseDetails>
  <ghg:CO2EndUseDetails>
    <ghg:ApplicationName>Fire fighting</ghg:ApplicationName>
    <ghg:ImportExport>Export</ghg:ImportExport>
    <ghg:QuantityofCO2 massUOM="Metric Tons">
      <ghg:MeasureValue>8.675</ghg:MeasureValue>
    </ghg:QuantityofCO2>
  </ghg:CO2EndUseDetails>
  <ghg:CO2EndUseDetails>
    <ghg:ApplicationName>Transportation and storage of explosives </ghg:ApplicationName>
    <ghg:ImportExport>Export</ghg:ImportExport>
    <ghg:QuantityofCO2 massUOM="Metric Tons">
      <ghg:MeasureValue>9.5345453</ghg:MeasureValue>
    </ghg:QuantityofCO2>
  </ghg:CO2EndUseDetails>
  <ghg:CO2EndUseDetails>
    <ghg:ApplicationName>Injection of CO2 for enhanced oil and natural gas recovery that is covered by 40 CFR Part 98, Subpart UU
    </ghg:ApplicationName>
  </ghg:CO2EndUseDetails>

```

```
<ghg:ImportExport>Export</ghg:ImportExport>
  <ghg:QuantityofCO2 massUOM="Metric Tons">
    <ghg:MeasureValue>10.234</ghg:MeasureValue>
  </ghg:QuantityofCO2>
</ghg:CO2EndUseDetails>
<ghg:CO2EndUseDetails>
  <ghg:ApplicationName>Geologic sequestration of carbon dioxide that is covered by 40 CFR Part 98, Subpart RR</ghg:ApplicationName>
  <ghg:ImportExport>Export</ghg:ImportExport>
  <ghg:QuantityofCO2 massUOM="Metric Tons">
    <ghg:MeasureValue>11.2242</ghg:MeasureValue>
  </ghg:QuantityofCO2>
</ghg:CO2EndUseDetails>
<ghg:CO2EndUseDetails>
  <ghg:ApplicationName>Research and Development</ghg:ApplicationName>
  <ghg:ImportExport>Export</ghg:ImportExport>
  <ghg:QuantityofCO2 massUOM="Metric Tons">
    <ghg:MeasureValue>12.46</ghg:MeasureValue>
  </ghg:QuantityofCO2>
</ghg:CO2EndUseDetails>
<ghg:EquipmentCalibrationDetails>
  <ghg:MeasuringEquipmentType>Mass flow meter</ghg:MeasuringEquipmentType>
  <ghg:StandardForCalibration>Standard A</ghg:StandardForCalibration>
</ghg:EquipmentCalibrationDetails>
<ghg:MassVolumeNumberofDaysSubstituted >1</ghg:MassVolumeNumberofDaysSubstituted>
<ghg:ConcentrationNumberofDaysSubstituted >2</ghg:ConcentrationNumberofDaysSubstituted >
<ghg:DensityNumberofDaysSubstituted >3</ghg:DensityNumberofDaysSubstituted >
</ghg:SubPartPP>
</ghg:SubPartInformation>
</ghg:FacilitySiteDetails>
<ghg:CalculationMethodologyChangesDescription/>
<ghg:BestAvailableMonitoringMethodsUsed/>
<ghg:StartDate>2013-01-01</ghg:StartDate>
<ghg:EndDate>2013-12-31</ghg:EndDate>
<ghg:DateTimeReportGenerated>2014-02-24T10:16:31</ghg:DateTimeReportGenerated>
</ghg:FacilitySiteInformation>
</ghg:GHG>
```