

# **Greenhouse Gas Reporting Program**

## **XML Reporting Instructions for Subpart C - General Stationary Fuel Combustion Sources**

United States Environmental Protection Agency  
Climate Change Division  
Washington, DC

February 6, 2018

*These instructions explain how to upload the required data for the applicable regulations. Owners and operators of units should refer to the applicable regulations for information about what data are required to be uploaded.*

*[This page intentionally left blank]*

## Table of Contents

	<u>Page</u>
I. Introduction.....	1
II. Summary of Changes .....	9
III. Subpart C Overview.....	9
<b>1.0 Subpart C Total Emissions .....</b>	<b>13</b>
<b>2.0 Configuration Identification Information.....</b>	<b>16</b>
2.1 Configuration Type 1 Identification.....	19
2.2 Configuration Type 2 Identification.....	24
2.3 Configuration Type 3 Identification.....	29
2.4 Configuration Type 4 Identification.....	33
2.5 Configuration Type 5 Identification.....	37
2.6 Configuration Type 6 Identification.....	41
2.7 Configuration Plant Code.....	44
<b>3.0 Configuration Level Emissions Information.....</b>	<b>46</b>
3.1 Configuration Type 1 Configuration Level Emissions.....	47
3.2 Configuration Type 2 Configuration Level Emissions.....	49
3.3 Configuration Type 3 Configuration Level Emissions.....	49
3.4 Configuration Type 4 Configuration Level Emissions.....	52
3.5 Configuration Type 5 Configuration Level Emissions.....	54
3.6 Configuration Type 6 Configuration Level Emissions.....	55
<b>4.0 Fuel Level Emissions by Configuration Type.....</b>	<b>61</b>
4.1 Tier 1 Fuel Details.....	65
4.2 Tier 2 Fuel Details.....	72
4.3 Tier 3 Fuel Details.....	84
4.4 Tier 4 Fuel Details.....	103
4.5 Part 75 Fuel Details .....	109
<b>5.0 Additional Configuration Level Emission Reporting.....</b>	<b>112</b>
5.1 Biogenic CO <sub>2</sub> Verification Data .....	112
5.2 Tier 4 Details .....	114
<b>6.0 Facility Level Roll-up Emissions.....</b>	<b>122</b>
IV. Appendix A: Sample XML Document for Subpart C.....	124

### List of Tables

		<u>Page</u>
Table 1	Reporting Numbers.....	2
Table 2	Calculated Details Data Element Definitions .....	5
Table 3	Measurement Details Data Element Definitions .....	5
Table 4	Unit Identification Details Data Element Definitions .....	6
Table 5	Greenhouse Gas Information Details Data Element Definitions.....	14
Table 6	Configuration Type 1 Unit Identification Data Element Definitions.....	20
Table 7	Configuration Type 1 Individual Unit Details Data Element Definitions .....	22
Table 8	Configuration Type 2 Unit Identification Data Element Definitions.....	25
Table 9	Configuration Type 2 Individual Unit Details Data Element Definitions .....	27
Table 10	Configuration Type 3 Unit Identification Data Element Definitions.....	30
Table 11	Small Unit Aggregation Details Data Element Definitions .....	31
Table 12	Configuration Type 4 Unit Identification Data Element Definitions.....	34
Table 13	Common Pipe Details Data Element Definitions .....	36
Table 14	Configuration Type 5 Unit Identification Data Element Definitions.....	38
Table 15	Common Stack Details Data Element Definitions .....	40
Table 16	Configuration Type 6 Unit Identification Data Element Definitions.....	42
Table 17	Configuration Plant Code Data Element Definitions.....	45
Table 18	Configuration Type 1 Configuration Level Emissions Data Element Definitions .....	48
Table 19	Configuration Type 3 Configuration Level Emissions Data Element Definitions .....	50
Table 20	Configuration Type 4 Configuration Level Emissions Data Element Definitions .....	52
Table 21	Configuration Type 6 Configuration Level Emissions Data Element Definitions .....	55
Table 22	Part 75 Details Data Element Definitions.....	57
Table 23	Appendix D and G Calculation Method Details Data Element Definitions .....	58
Table 24	CEMS Details Data Element Definitions .....	60
Table 25	Tier Fuel Details Data Element Definitions.....	62
Table 26	Tier 1 Fuel Details Data Element Definitions .....	66
Table 27	Tier 1 Emissions Details Node Data Element Definitions .....	67
Table 28	Tier 1 Equation Inputs Data Element Definitions .....	70
Table 29	Tier 2 Fuel Details Data Element Definitions .....	73
Table 30	Tier 2 Monthly HHV Details Data Element Definitions.....	75
Table 31	Tier 2 Monthly HHV Details Emissions Details Node Data Element Definitions.....	78
Table 32	Tier 2 Equation C2aC9a Data Element Definitions.....	81
Table 33	Tier 2 Equation C2cC9b Data Element Definitions.....	83
Table 34	Tier 3 Fuel Details Data Element Definitions .....	85
Table 35	Tier 3 Fuel Details Emissions Details Node Data Element Definitions.....	87
Table 36	Tier 3 Equation C3C8 Data Element Definitions .....	90
Table 37	Tier 3 Equation C4C8 Data Element Definitions .....	93
Table 38	Tier 3 Equation C5C8 Data Element Definitions .....	96
Table 39	Tier 3 Fuel Details Data Element Definitions .....	100

Table 40	Tier 4 Fuel Details Data Element Definitions .....	104
Table 41	Tier 4 Equation C10 Inputs Data Element Definitions .....	106
Table 42	Tier 4 Equation C13 Inputs Data Element Definitions .....	107
Table 43	Part 75 Fuel Details Data Element Definitions .....	110
Table 44	Biogenic CO <sub>2</sub> Verification Details Data Element Definitions .....	113
Table 45	Tier 4 Details Data Element Definitions .....	115
Table 46	Operating Hours Details Data Element Definitions.....	118
Table 47	Biogenic Portion Details Data Element Definitions .....	120
Table 48	Facility Level Roll-up Emissions Data Element Definitions .....	123

## List of Figures

	<u>Page</u>
Figure 1 Example of an XML Tree.....	3
Figure 2 Calculated Details Data Type Schema Diagram.....	4
Figure 3 Measurement Details Data Type Schema Diagram.....	5
Figure 4 Unit Identification Details Data Type Schema Diagram.....	6
Figure 5 “Unbounded” Symbol in Schema Diagram.....	7
Figure 6 Logical “Or” Symbol in Schema Diagram.....	8
Figure 7 Subpart C Reporting Diagram.....	10
Figure 8 Subpart C Schema Diagram.....	12
Figure 9 Greenhouse Gas Information Details Schema Diagram.....	13
Figure 10 Units C Details for Configuration Type 1 Schema Diagram.....	19
Figure 11 Configuration Type 1 Unit Identification Schema Diagram.....	20
Figure 12 Configuration Type 1 Individual Unit Details Schema Diagram.....	22
Figure 13 Units C Details for Configuration Type 2 Schema Diagram.....	24
Figure 14 Configuration Type 2 Unit Identification Schema Diagram.....	25
Figure 15 Configuration Type 2 Individual Unit Details Schema Diagram.....	27
Figure 16 Units C Details for Configuration Type 3 Schema Diagram.....	29
Figure 17 Configuration Type 3 Unit Identification Schema Diagram.....	30
Figure 18 Small Unit Aggregation Details Schema Diagram.....	31
Figure 19 Units C Details for Configuration Type 4 Schema Diagram.....	33
Figure 20 Configuration Type 4 Unit Identification Schema Diagram.....	34
Figure 21 Common Pipe Details Schema Diagram.....	35
Figure 22 Units C Details for Configuration Type 5 Schema Diagram.....	37
Figure 23 Configuration Type 5 Unit Identification Schema Diagram.....	38
Figure 24 Common Stack Details Schema Diagram.....	39
Figure 25 Units C Details for Configuration Type 6 Schema Diagram.....	41
Figure 26 Configuration Type 6 Unit Identification Schema Diagram.....	42
Figure 27 Configuration Plant Code Schema Diagram.....	44
Figure 28 Configuration Level Emissions Data.....	46
Figure 29 Configuration Type 1 Configuration Level Emissions.....	47
Figure 30 Configuration Type 3 Configuration Level Emissions Schema Diagram.....	50
Figure 31 Configuration Type 4 Configuration Level Emissions Schema Diagram.....	52
Figure 32 Configuration Type 6 Configuration Level Emissions Schema Diagram.....	55
Figure 33 Part 75 Details Schema Diagram.....	56
Figure 34 Appendix D and G Calculation Method Details Schema Diagram.....	58
Figure 35 CEMS Details Schema Diagram.....	59
Figure 36 Tier Fuel Details Schema Diagram.....	61
Figure 37 Tier 1 Fuel Details Schema Diagram.....	65
Figure 38 Tier 1 Fuel Details Equation C1C8 Inputs Schema Diagram.....	69
Figure 39 Tier 1 Fuel Details Equation C1aC8a Inputs Schema Diagram.....	69

Figure 40	Tier 1 Fuel Details Equation C1bC8b Inputs Schema Diagram.....	70
Figure 41	Tier 2 Fuel Details Schema Diagram.....	72
Figure 42	Tier 2 Monthly HHV Details Schema Diagram.....	74
Figure 43	Tier 2 Emissions Details Node Schema Diagram.....	77
Figure 44	EquationC2aC9a Inputs Schema Diagram .....	80
Figure 45	Equation C2cC9b Inputs Schema Diagram .....	82
Figure 46	Tier 3 Fuel Details Schema Diagram.....	84
Figure 47	Tier 3 Emissions Details Node Schema Diagram.....	86
Figure 48	Tier 3 Equation Inputs Schema Diagram .....	88
Figure 49	Tier 3 Equation C3C8 Inputs Schema Diagram.....	89
Figure 50	Tier 3 Equation C4C8 Inputs Schema Diagram.....	92
Figure 51	Tier 3 Equation C5C8 Inputs Schema Diagram.....	95
Figure 52	Additional Tier 3 Fuel Details Schema Diagram .....	98
Figure 53	Tier 4 Fuel Details Schema Diagram.....	103
Figure 54	Equation C10 Inputs Schema Diagram.....	105
Figure 55	Equation C13 Inputs Schema Diagram.....	107
Figure 56	Part 75 Fuel Details Schema Diagram .....	109
Figure 57	Biogenic Portion of CO <sub>2</sub> Emissions and Portion Verification Schema Diagram.....	112
Figure 58	Tier 4 Details Schema Diagram .....	114
Figure 59	Tier 4 Quarter Details Schema Diagram .....	115
Figure 60	Operating Hours Details Schema Diagram.....	117
Figure 61	Biogenic Portion Details Schema Diagram .....	119
Figure 62	Facility-Level Roll-up Emissions Schema Diagram.....	122

### List of XML Excerpts

	<u>Page</u>
XML Excerpt 1 Example for “Unbounded” Parent Element .....	7
XML Excerpt 2 Example for Greenhouse Gas Information Details .....	15
XML Excerpt 3 Example for Configuration Type 1 Unit Identification .....	21
XML Excerpt 4 Example for Configuration Type 1 Individual Unit Details .....	23
XML Excerpt 5 Example for Configuration Type 2 Unit Identification .....	26
XML Excerpt 6 Example for Configuration Type 2 Individual Unit Details .....	28
XML Excerpt 7 Example for Configuration Type 3 Unit Identification .....	31
XML Excerpt 8 Example for Small Unit Aggregation Details .....	32
XML Excerpt 9 Example for Configuration Type 4 Unit Identification .....	35
XML Excerpt 10 Example for Common Pipe Details.....	36
XML Excerpt 11 Example for Configuration Type 5 Unit Identification .....	39
XML Excerpt 12 Example for Common Stack Details .....	40
XML Excerpt 13 Example for Configuration Type 6 Unit Identification .....	42
XML Excerpt 14 Example for Configuration Type 1 Configuration Level Emissions .....	45
XML Excerpt 15 Example for Configuration Type 1 Configuration Level Emissions .....	48
XML Excerpt 16 Example for Configuration Type 3 Configuration Level Emissions .....	51
XML Excerpt 17 Example for Configuration Type 4 Configuration Level Emissions .....	53
XML Excerpt 18 Example for Configuration Type 6 Configuration Level Emissions .....	55
XML Excerpt 19 Example for Part 75 Details .....	57
XML Excerpt 20 Example for Appendix D and G Calculation Method Details.....	59
XML Excerpt 21 Example for CEMS Details.....	60
XML Excerpt 22 Example for Tier Fuel Details .....	64
XML Excerpt 23 Example for Tier 1 Fuel Details .....	66
XML Excerpt 24 Example for Tier 1 Emissions Details Node.....	68
XML Excerpt 25 Example for Equation C1C8 Inputs .....	71
XML Excerpt 26 Example for Equation C1aC8a Inputs.....	71
XML Excerpt 27 Example for Equation C1bC8b Inputs .....	71
XML Excerpt 28 Example for Tier 2 Fuel Details .....	73
XML Excerpt 29 Example for Tier 2 Monthly HHV Details .....	76
XML Excerpt 30 Example for Tier 2 Monthly HHV Details Emissions Details Node .....	79
XML Excerpt 31 Example for Tier 3 Fuel Details .....	85
XML Excerpt 32 Example for Tier 3 Fuel Details Emissions Details Node .....	102
XML Excerpt 33 Example for Tier 4 Fuel Details .....	105
XML Excerpt 34 Example for Equation C10 Inputs.....	106
XML Excerpt 35 Example for Equation C13 Inputs.....	108
XML Excerpt 36 Example for Part 75 Fuel Details.....	111
XML Excerpt 37 Example for Biogenic Portion of CO <sub>2</sub> Emissions and Portion Verification Data .....	113
XML Excerpt 38 Example for Tier 4 Details.....	116
XML Excerpt 39 Example for Operating Hours Details .....	119



XML Excerpt 40 Example for Biogenic Portion Details..... 121  
XML Excerpt 41 Example for Facility Level Roll-up Emissions ..... 123



## I. Introduction

This document provides a step-by-step description of how to report emissions data to the EPA electronic greenhouse gas reporting tool (e-GGRT) using the Greenhouse Gas (GHG) XML schema. The GHG XML schema contains all of the data elements needed to comply with the Greenhouse Gas Reporting Program (GHGRP). The schema defines expected data elements and attributes, allowable data formats for each data element, and the hierarchical structure and sequence in which data elements are placed within the XML file.

The GHG XML schema's root data element is "GHG". The data elements within the schema are related to each other in parent-child relationships. The root data element is the parent of the entire schema.

The e-GGRT XML upload method may be used for reporting a facility or supplier's annual GHG data. However, the following actions must be performed using only the e-GGRT web forms:

- User, facility and supplier registration
- Certificate of Representation and Notice of Delegation signing
- Facility representative and agent changes
- Facility and supplier address changes
- Notice of intent to not submit an annual GHG report

Every XML file submitted to e-GGRT must be well-formed and conform to the current version of the GHG schema. Every XML file must contain GHG data only for a single facility or supplier. Reporters are required to submit a single XML file containing all emissions data for a facility or supplier as a complete report. The XML file must include all of the relevant Subparts. Reporters cannot submit a portion of a facility's data to add, delete, correct or update. To make any modification to previously submitted emissions data, a reporter must resubmit the entire set of emissions data. Each subsequent submission for the same facility replaces all of the previously submitted data.

The schema contains enumerated lists of the units of measures for some data elements and allowable values for some data elements. For rules regarding the unit of measure or allowable values for a specific data element, please refer to the appropriate Data Element Definitions table.

The reporting schema is available for download at the e-GGRT help website:

<http://www.ccdsupport.com/confluence/display/help/XML+Reporting+Instructions>. The page includes:

- **Schema zip file with the master GHG\_Final\_vN.n.xsd and supporting subpart and component xsd files for the current reporting year.**
- **Schema change log files and year to year comparison reports.**

**Table 1**  
**Reporting Numbers**

Number Format	Description
Rounding	<ul style="list-style-type: none"> <li>• CO<sub>2</sub>e and CO<sub>2</sub> emissions data expressed in metric tons should be rounded to one decimal place. This should be done regardless of the level of data collection (e.g., unit-level, facility-level). Quantities less than 0.05 metric tons would round to 0.0 and be reported as such. Quantities greater than or equal to 0.05 metric tons would round up to 0.1 and be reported as such.</li> <li>• CH<sub>4</sub> emissions data expressed in metric tons should be rounded to two decimal places.</li> <li>• N<sub>2</sub>O emissions data expressed in metric tons should be rounded to three decimal places.</li> <li>• Emissions data for all GHGs other than CO<sub>2</sub>, N<sub>2</sub>O and CH<sub>4</sub> expressed in metric tons should be rounded to the fourth digit to the right of the decimal (one tenth of a kilogram, or 1 ten thousandth of a metric ton). This rounding should be applied regardless of the level of data collection (unit, facility, etc.).</li> <li>• Other (non-emissions) quantitative data reported by the user (e.g., a monthly HHV sample result, an annual production quantity) will not need to be rounded.</li> <li>• In the case of aggregation/roll-ups, those calculations should be performed on the rounded values.</li> </ul>
Percentages	If a value is reported as a percentage, then the number should be within the range of 0 to 100 (percent). For example, 85.5% is reported as 85.5.
Fractions	If a value must be reported as a decimal fraction, then the number should be within the range of 0 and 1, (e.g., 1/4 should be reported as 0.25). Leading zeroes are optional.

### Key XML Terms

- **MRR:** Greenhouse Gas Reporting Rule reference.
- **XML:** A markup language for documents containing structured information. The XML specification defines a standard way to add markup to documents. Its primary purpose is to facilitate the sharing of structured data across different information systems, particularly via the internet.
- **XML Schema:** An XML schema describes the structure of an XML document. The schema also defines the set of rules to which the XML document must conform in order to be considered "valid".
- **XML file:** A file containing data organized into a structured document using XML markup.

- **Data Element:** An XML data element is used for storing and classifying data in an XML file. Opening and closing tags represent the start and end of a data element. An opening tag looks like <elementName>, while a closing tag has a slash that is placed before the element's name </elementName>. The following example shows how to report the facility's identification number: <FacilitySiteIdentifier>23222</FacilitySiteIdentifier>. The information shaded in blue represents the data element's value.

If a data element does not contain a value, then a single empty tag name may be used. An empty tag has a slash placed after the element's name <FacilitySiteIdentifier/>. **Note:** If you do not intend to report a value for a particular data element, then it is recommended that you do not include the data element in the XML file.

- **Attribute:** An XML attribute contains additional information about a specific data element. An attribute for a data element is placed within the opening tag. The syntax for including an attribute in an element is <elementName attributeName="value">. For example, <TotalCH4CombustionEmissions massUOM="Metric Tons">.
- **Root/Parent/Child Element:** The schema's structure is like a family tree. At the top of the tree is some early ancestor and at the bottom of the tree are the latest children. With a tree structure you can see which children belong to which parents and many other relationships.

XML data elements are sometimes referenced in terms of how they relate to each other, such as in a parent-to-child relationship. The top of the XML tree is considered the root – it is the parent to all data elements within the schema. In the example below, “GHG\_Unit\_Details” is the root, and just like in many other family trees, there is more than one item with the same name (e.g., “Unit\_ID”). The easiest way to distinguish these items is by referencing them in terms of their parent-child relationships, e.g., NoCEMS /Unit\_ID vs. CEMS/Unit\_ID.

**Figure 1**  
**Example of an XML Tree**

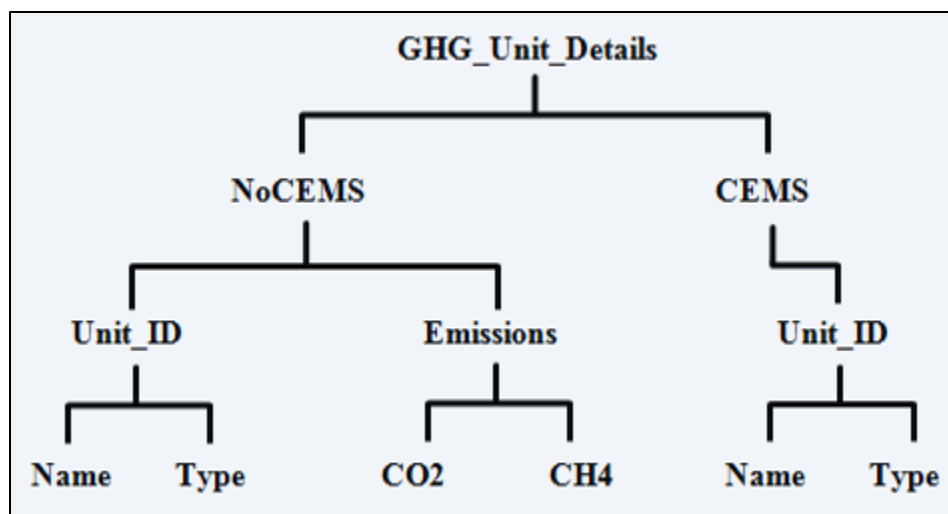

This document provides a step-by-step description of how to report emissions data using the XML schema. Please note the following seven tips on preparing your XML file:

- **Do not include non-applicable data elements in your facility's XML file.** The schema contains many data elements, some of which may not be applicable to XML reporters in general or to a particular situation. If the instructions (definition tables) do not reference a particular data element, then **do not** report or include it in your facility's XML file.
- **Sequence data elements in the order specified by the schema.** The figures and tables in this document depict the proper sequence in which data elements are arranged in the XML file to produce a well-formed XML report.
- **Enumerations are case sensitive.** Many data elements have a defined set of allowable values, also known as enumerations. Report values for enumerations exactly as they are defined within the schema, including punctuation marks. See the definition tables for a complete list of enumerations.
- **Schema diagrams depict the hierarchy (or tree structure).** The primary purpose of the schema diagrams is to indicate the sequence in which data elements must appear within the facility's XML file and to identify the data elements that are required (must be reported) and conditionally required (see last bullet). Required data elements are boxed in red and conditionally required data elements are noted.
- **Definition tables provide details for required and conditionally required data elements.** The tables are designed to provide unique instructions for reporting a given data element, including the list of enumerations and required units of measure, if defined. As noted above, there are some data elements in the schema that are not applicable to XML reporters or to a particular situation. For example, the "OverrideIndicator" data element is used solely by e-GGRT to indicate that the web form reporter chose to override the system's calculated value with their own. These non-applicable data elements **are not** included in the definition tables. If a data element is not referenced in a definition table, then **do not** report or include it in the facility's XML file.
- **The schema diagrams do not depict commonly used data types.** The schema diagrams display almost every data element in the schema except the data elements that are associated with the three most commonly occurring data types:
  - Calculated Details
  - Measurement Details
  - Unit Identification Details

Once defined, these commonly used data types (static collection of data elements) are associated as children to every data element in the schema containing a measured or calculated value or unit details. These child data elements do not appear in the diagrams and are not listed on separate rows in the definition tables in order to reduce their redundancy. They are, however, referenced in the definition tables in the description of their parent data element.

- **Conditionally required data elements.** Conditionally required data elements are noted in the schema diagrams and the data element definitions tables. If your facility meets the condition specified for the data element, then the data element is required and you must include it in your facility's XML file. If your facility does not meet the condition specified for the data element, then **do not** include the data element in the facility's XML file. **Do not** include a parent element that is not required, nor include any of its child data elements in your facility's XML file.

**Figure 2**  
**Calculated Details Data Type Schema Diagram**

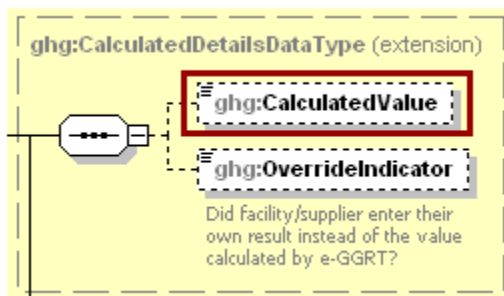

**Note:** Data elements boxed in red are required.

**Table 2**  
**Calculated Details Data Element Definitions**

Data Element Name	Description
<b>CalculatedDetailsDataType</b>	
CalculatedValue	Calculated value (decimal).
OverrideIndicator	<b>Note:</b> Do not include this data element in the facility’s XML file because it only applies to web form reporters. It is a flag set by e-GGRT to indicate that the system-calculated value was overridden with the web form reporter’s value.

**Figure 3**  
**Measurement Details Data Type Schema Diagram**

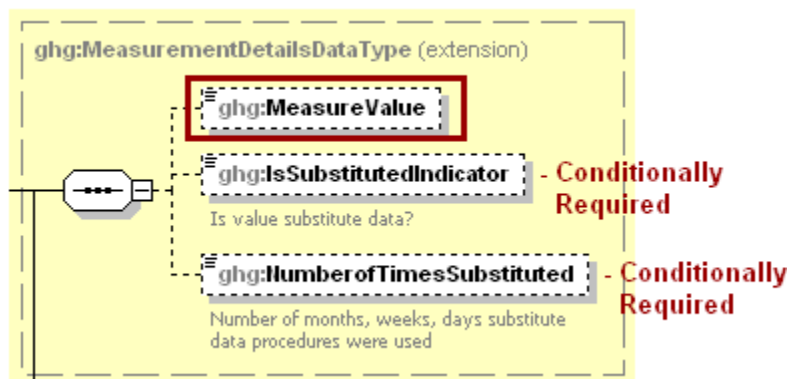

**Note:** Data elements boxed in red are required. Please see page 4 of this document for more information on conditionally required elements.

**Table 3**  
**Measurement Details Data Element Definitions**

Data Element Name	Description
<b>MeasurementDetailsDataType</b>	
MeasureValue	Measured value (decimal).
IsSubstitutedIndicator	An indication (Y/N) that the measured value contains substituted data.  <b>Note:</b> Do not include this data element in your XML file unless noted in the instructions for the particular measured value.
NumberOfTimesSubstituted	The number (integer) of days, months, weeks, or hours in the reporting year that missing data procedures were followed.  <b>Note:</b> Do not include this data element in your XML file unless noted in the instructions for the particular measured value.

**Figure 4**  
**Unit Identification Details Data Type Schema Diagram**

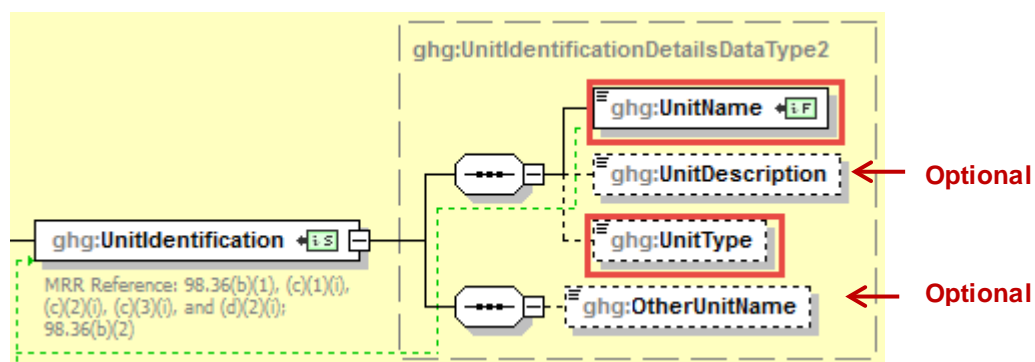

**Note:** Data elements boxed in red are required.

**Table 4**  
**Unit Identification Details Data Element Definitions**

Data Element Name	Description
<b>UnitIdentificationDetails</b>	
UnitName	A unique name (ID) for each unit so that the data for different units can be recorded, maintained and retrieved clearly.
UnitDescription	Optional brief description of the unit.
UnitType	The type of unit. The list of allowable values varies. For more information, see the instructions for the specific unit process to be reported. For example, if reporting Flare Gas details, the unit type would be “Flare”.



Data Element Name	Description
OtherUnitName	Optional other name for the unit.

The XML symbol “0..∞” shown in Figure 5 means that the parent element is “unbounded” so that multiple instances of the parent element can be reported. XML Excerpt 1 shows an example of reporting multiple instances of a parent element.

**Figure 5**  
“Unbounded” Symbol in Schema Diagram

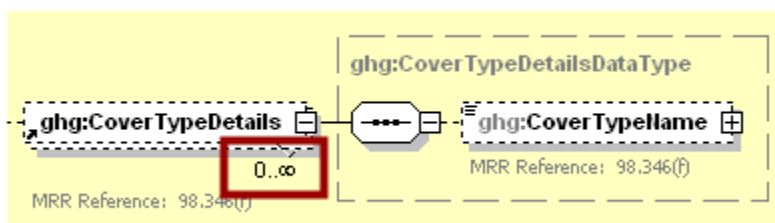

**XML Excerpt 1**  
Example for “Unbounded” Parent Element

```

<ghg:CoverTypeDetails>
  <ghg:CoverTypeName>Organic cover</ghg:CoverTypeName>
</ghg:CoverTypeDetails>
<ghg:CoverTypeDetails>
  <ghg:CoverTypeName>Clay cover</ghg:CoverTypeName>
</ghg:CoverTypeDetails>
<ghg:CoverTypeDetails>
  <ghg:CoverTypeName>Sand cover</ghg:CoverTypeName>
</ghg:CoverTypeDetails>

```

The XML symbol for a logical “Or” shown in Figure 6 means that **only one** of the data elements following the symbol can be reported for the current instance of the parent element.

**Figure 6**  
**Logical “Or” Symbol in Schema Diagram**

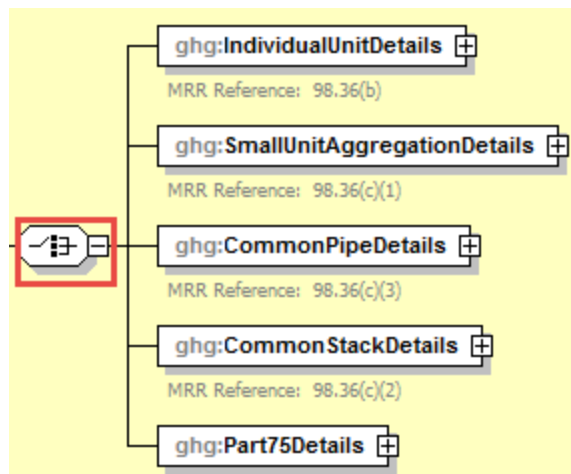

## II. Summary of Changes

Substantive changes to the Subpart C XML schema and reporting guidelines for Reporting Year 2017 include:

- New data elements in the GHGasInfoDetails node (GHGasCASRegistryNumber, GHGasLinearChemicalFormula, OtherGHGasCASRegistryNumber, and OtherGHGaslinearChemicalFormula) now appear in the schema but are only applicable to gases other than Carbon Dioxide, Methane, Nitrous Oxide, and Biogenic Carbon Dioxide so they **should NOT be used in the reporting of Subpart C** (see Table 5 of this document).
- If your fuel is Wood or Wood Residuals and you choose to specify your high heating value (HHV) rather than use the default HHV you must also report moisture content in addition to the calculated Moisture Adjusted HHV (see Tier 1 Fuel Details for Equation C1-C8)
- For Tier 2 monthly calculations of HHV in Eq - C2b you may specify a month or months not applicable (See Tier 2 Eq-C2a C9a). Similarly, you may specify one or more months not applicable in Eq - C2c (See Tier 2 Eq-C2c C9b).
- For Tier 3 monthly calculations of HHV in Eq - C2b you may specify a month or months not applicable (See Tier 3 Eq-C3 C8, Eq-C4 C8, and Eq-C5 C8)
- For both Common Pipe and Aggregation of Units configurations you must all report “Cumulative maximum rated heat input capacity of for all units within the configuration that have a maximum rated heat input capacity greater than or equal to 10 mmBtu/hr” in the CumulativeMaximumRatedHeatInputCapacity node for each configuration.
- The facility plant code has been modified to accept multiple, comma delimited, six digit plant codes.

### III. Subpart C Overview

This section provides a brief overview of Subpart C – General Stationary Fuel Combustion Sources for Part 98. It includes a definition of the source category, the basic reporting requirements, and a description of this document’s layout.

**Figure 7  
Subpart C Reporting Diagram**

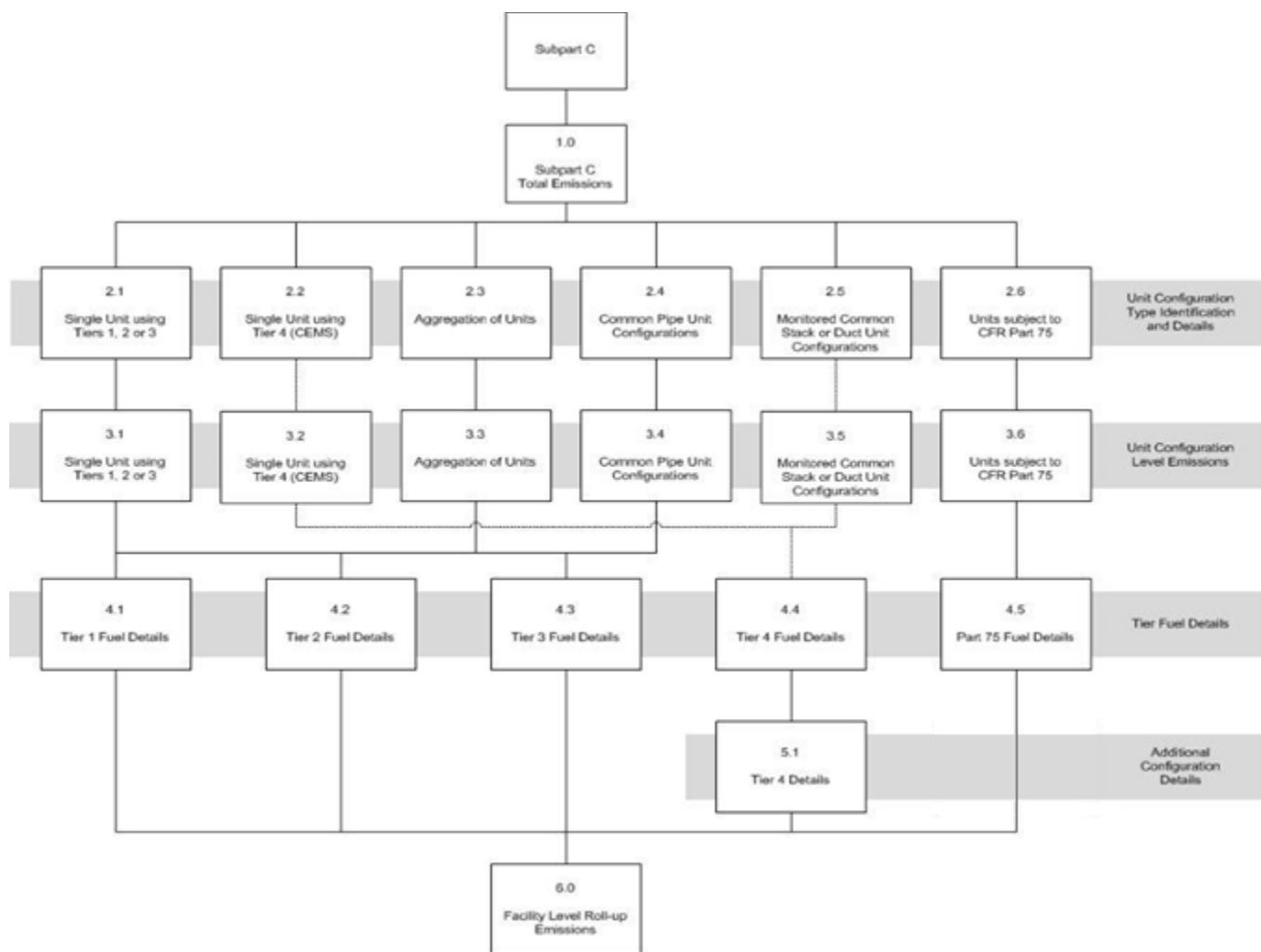

Stationary fuel combustion sources are devices that combust solid, liquid, or gaseous fuel, generally for the purposes of producing electricity, generating steam or providing useful heat or energy for industrial, commercial or institutional use, or reducing the volume of waste by removing combustible matter. Stationary fuel combustion sources include, but are not limited to, boilers, simple and combined-cycle combustion turbines, engines, incinerators and process heaters. This source category does not include portable equipment, emergency equipment or emergency generators, as defined in §98.6.

The XML schema includes the following areas for reporting for Subpart C, as displayed in the reporting diagram:

- 1.0 Subpart C Total Emissions: includes the total greenhouse gas emissions required to be reported for Subpart C.
- 2.0 Configuration Identification Information: includes unit configuration type identification and details.
- 3.0 Unit Configuration Level Emissions: includes information on how to report emissions based on configuration type.
- 4.0 Tier Fuel Details: includes how to report fuel information based on the tier methodology used.
- 5.0 Additional Configuration Details: includes additional information to report for Tier 4 and Part 75 methodologies.
- 6.0 Facility Level Roll-up Emissions: includes information on how to report total emissions for CO<sub>2</sub>e (excluding biogenic CO<sub>2</sub>) and biogenic CO<sub>2</sub> from Subpart C at the facility level.

The figure below depicts the overall structure of the XML schema as it relates to Subpart C. This document provides instruction for reporting data elements based on the order in which they are placed within the schema. As a result, there are two sections (3.0 and 5.0) for configuration level emissions information.

**Figure 8**  
**Subpart C Schema Diagram**

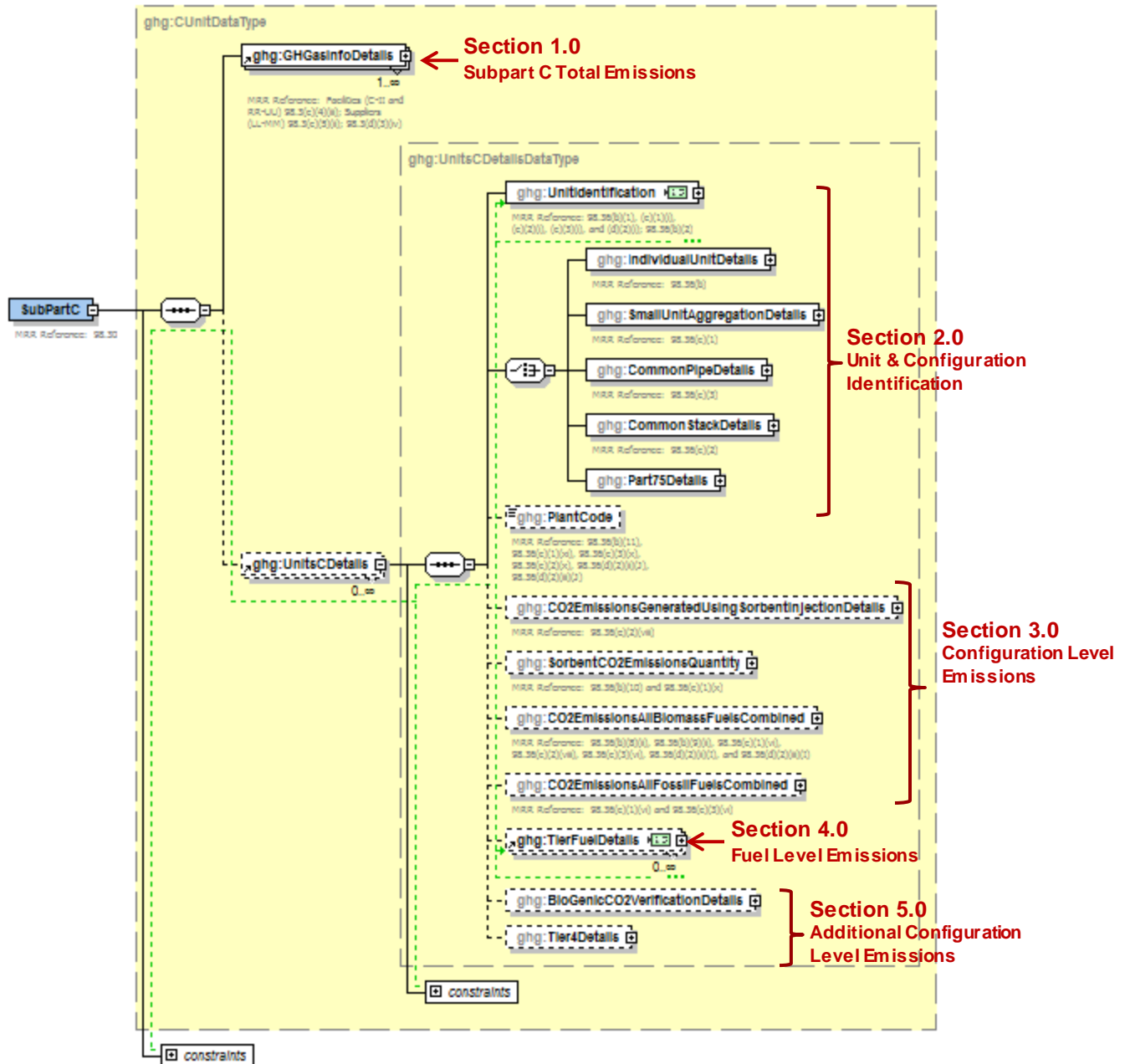

Note: Data elements boxed in red are required.

## 1.0 Subpart C Total Emissions

Greenhouse gas information details comprise a collection of data elements to report the total annual emissions of each greenhouse gas (GHG) listed in Table A-1 of 40 CFR 98 Mandatory Reporting of Greenhouse Gases reported under Subpart C, expressed in metric tons.

**Figure 9**  
**Greenhouse Gas Information Details Schema Diagram**

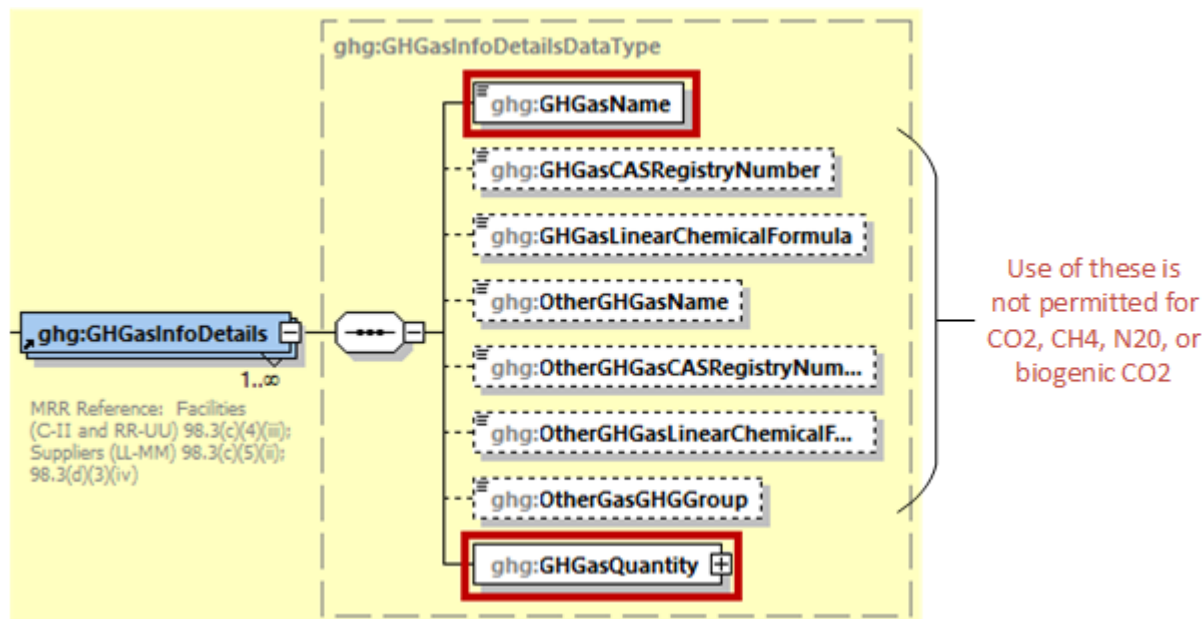

**Note:** Data elements boxed in red are required.

For Subpart C, report the gas name and emissions for biogenic carbon dioxide (CO<sub>2</sub>), CO<sub>2</sub> (excluding biogenic CO<sub>2</sub>), methane (CH<sub>4</sub>) and nitrous oxide (N<sub>2</sub>O); do not report the CAS Registry Number, Linear Chemical Formula, or the other gas data elements for CO<sub>2</sub>, biogenic CO<sub>2</sub>, CH<sub>4</sub>, or N<sub>2</sub>O. For greenhouse gas quantity, report the calculated value and mass unit of measure (Metric Tons) only according to the following guidelines:

### 1) Total CO<sub>2</sub> emissions (excluding biogenic CO<sub>2</sub>):

- For Configuration Types 1 and 3, add the CO<sub>2</sub> emissions (include both biogenic and non-biogenic CO<sub>2</sub>) for each fuel and for each configuration in metric tons, add the CO<sub>2</sub> emissions from sorbent use for each configuration in metric tons and subtract the total biogenic CO<sub>2</sub> emissions for each configuration in metric tons.
- For Configuration Types 2, 5 and 6, add the CO<sub>2</sub> emissions (include both biogenic and non-biogenic CO<sub>2</sub>) measured by the CEMS or applicable Part 75 methodology for each configuration in metric tons and subtract the total biogenic CO<sub>2</sub> emissions for each configuration in metric tons.
- For Configuration Type 4, add the CO<sub>2</sub> emission (include both biogenic and non-biogenic CO<sub>2</sub>) for each fuel and for each configuration in metric tons and subtract the total biogenic CO<sub>2</sub> emissions for each configuration in metric tons.

2) Total biogenic CO<sub>2</sub> emissions:

- Add the total annual biogenic CO<sub>2</sub> emissions for each configuration in metric tons. This includes CO<sub>2</sub> emissions from biomass fuels and the biogenic portion of CO<sub>2</sub> emissions from mixed biomass and fossil fuels (i.e. MSW and tires).

3) Total CH<sub>4</sub> emissions:

- For Configuration Types 1 through 5, add the values reported for CH<sub>4</sub> emissions for each fuel and for each configuration in metric tons.
- For Configuration Type 6, divide the values reported for CH<sub>4</sub> emissions in CO<sub>2</sub>e by the Global Warming Potential for CH<sub>4</sub> and add the result. The CH<sub>4</sub> Global Warming Potential values for reporting year 2010-2012 and reporting year 2013 and onward, are 21 and 25, respectively.

4) Total N<sub>2</sub>O emissions:

- For Configuration Types 1 through 5, add the values reported for N<sub>2</sub>O emissions for each fuel and for each configuration in metric tons.
- For Configuration Type 6, divide the values reported for N<sub>2</sub>O emissions in CO<sub>2</sub>e by the Global Warming Potential for N<sub>2</sub>O and add the result. The N<sub>2</sub>O Global Warming Potential values for reporting year 2010-2012 and reporting year 2013 and onward, are 310 and 298, respectively.

**Note:** You must follow the rounding rules found in [Table 1](#).

**Table 5**  
**Greenhouse Gas Information Details Data Element Definitions**

Data Element Name	Description
<b>GHGasInfoDetails</b>	<b>Parent Element:</b> A collection of data elements containing the total annual emissions of each greenhouse gas (GHG) listed in Table A-1 of 40 CFR 98 Mandatory Reporting of Greenhouse Gases, reported under this Subpart, expressed in metric tons.
GHGasName	Specify the name of the GHG. See list of allowable values:  Carbon Dioxide Biogenic Carbon dioxide Methane Nitrous Oxide



Data Element Name	Description
GHGasQuantity	A collection of data elements that quantify the annual emissions from this source category. Report the value in the child data element <b>CalculatedValue</b> using the guidelines above. Set the units of measure to "Metric Tons" in the attribute <b>massUOM</b> .

### XML Excerpt 2 Example for Greenhouse Gas Information Details

```

<ghg:SubPartC>
  <ghg:GHGasInfoDetails>
    <ghg:GHGasName>Biogenic Carbon dioxide</ghg:GHGasName>
    <ghg:GHGasQuantity massUOM="Metric Tons">
      <ghg:CalculatedValue>14700.3</ghg:CalculatedValue>
    </ghg:GHGasQuantity>
  </ghg:GHGasInfoDetails>
  <ghg:GHGasInfoDetails>
    <ghg:GHGasName>Methane</ghg:GHGasName>
    <ghg:GHGasQuantity massUOM="Metric Tons">
      <ghg:CalculatedValue>4065.72</ghg:CalculatedValue>
    </ghg:GHGasQuantity>
  </ghg:GHGasInfoDetails>
  <ghg:GHGasInfoDetails>
    <ghg:GHGasName>Nitrous Oxide</ghg:GHGasName>
    <ghg:GHGasQuantity massUOM="Metric Tons">
      <ghg:CalculatedValue>398.581</ghg:CalculatedValue>
    </ghg:GHGasQuantity>
  </ghg:GHGasInfoDetails>
  <ghg:GHGasInfoDetails>
    <ghg:GHGasName>Carbon Dioxide</ghg:GHGasName>
    <ghg:GHGasQuantity massUOM="Metric Tons">
      <ghg:CalculatedValue>518460.9</ghg:CalculatedValue>
    </ghg:GHGasQuantity>
  </ghg:GHGasInfoDetails>
</aha:GHGasInfoDetails>

```

**Note:** The code excerpt above is presented here to demonstrate the concept of reporting greenhouse gas emissions data

## 2.0 Configuration Identification Information







For stationary combustion sources required to report under Subpart C, e-GGRT requires you to identify which reporting option each unit or group of units will be using to report emissions. The different Subpart C reporting options are referred to as Configurations in e-GGRT. The individual configurations are designed to match the reporting options made available by the rule in 40 CFR 98.36. As specified in part 98, each configuration has slightly different reporting requirements. Emissions information to be reported is either aggregated at the configuration level or is to be reported for a specific fuel combusted in the configuration. A facility may have multiple configuration types and/or multiple configurations of any given type.

To create a valid XML file, complete data must be reported for one configuration at the facility before reporting data for another configuration at the facility.



### *Which configuration type(s) will you use to report emissions?*

The unit or group configuration types are as follows:

-  [Configuration Type 1](#) – A single unit that uses Tier 1, 2, or 3 to calculate emissions [98.36(b)]
-  [Configuration Type 2](#) – A single unit employing CEMS (Tier 4) to measure emissions [98.36(b)]
-  [Configuration Type 3](#) – A reporting alternative for aggregating a group of small units (i.e., maximum rated heat input capacity of largest unit less than or equal to 250 mmBtu/hr) that use Tier 1, 2, or 3 to calculate emissions [98.36(c)(1)]
-  [Configuration Type 4](#) – A reporting alternative for a group of units sharing a common gaseous or liquid fuel supply pipe and that use Tier 1, 2, or 3) to calculate emissions [98.36(c)(3)]
-  [Configuration Type 5](#) – A group of units sharing a common exhaust stack employing CEMS (Tier 4) to measure emissions and reporting under the monitored common stack or duct configurations reporting alternative [98.36(c)(2)]
-  [Configuration Type 6](#) – Part 75 units using the alternative CO<sub>2</sub> mass emissions calculation methods provided for year-round heat input reporters in 98.33(a)(5) [98.36(d)(2)]

The configuration types are described in further detail below. For more information on the different reporting options, please refer to the applicable paragraphs in 40 CFR 98.36.

### **Configuration Type 1 - Single Unit Using Tiers 1, 2 or 3 [98.36(b)]**

The single unit reporting configuration is the most basic configuration type. Any unit may be reported individually in e-GGRT. If the unit uses Tiers 1, 2 or 3 to calculate CO<sub>2</sub> emissions, it must be reported as a configuration of Type 1. If the use of Tier 4 is required or elected, Configuration Type 2 or 5 must be used.

A unit under Configuration Type 1 may combust multiple fuels, and it is possible for the different fuels to be reported using different tiers. For example, a unit with a maximum rated heat input capacity of 500 mmBtu/hr may be required to use Tier 3 for coal, but only Tier 2 for natural gas or fuel oil.

Facilities with numerous units should investigate if Configuration Type 3 (aggregation of units) or Type 4 (common pipe) may be used.



See [Section 2.1](#) for instructions on how to report for Configuration Type 1.

**Configuration Type 2 – Single Unit Using Tier 4 [98.36(b)]**

Configuration Type 2 is the reporting option for single units that are either required or elect to use Tier 4 (CEMS). CO<sub>2</sub> emissions will be reported for all fuels combined, but CH<sub>4</sub> and N<sub>2</sub>O emissions will still need to be reported on a fuel by fuel basis.

Should a unit change methodology from Tiers 1-3 to Tier 4 during the year, the unit will need to be added as two separate configurations in e-GGRT with different configuration names.

If a single CEMS is used to monitor multiple units (multiple combustion, or one combustion and one or more process units), Configuration Type 5 should be used instead.

➡ See [Section 2.2](#) for instructions on how to report for Configuration Type 2.

**Configuration Type 3 – Aggregation of Units [98.36(c)(1)]**

The *aggregation of units* option is a reporting configuration that allows multiple ‘small’ units to be reported as a single entity provided that certain conditions are met. If this reporting option is selected, emissions from all units grouped in this configuration will be reported as combined emissions in e-GGRT.

If a facility contains two or more units, each of which has a maximum rated heat input capacity of 250 mmBtu/hr or less, you may report these units as a single reporting configuration of Type 3 in e-GGRT, provided that only Tiers 1-3 are used and the units use the same tier for any common fuels combusted. Fuels of different types may use different tiers, as permitted. There is no limit on the number of units that may be included in this configuration provided the previous criteria are met.

While the use of Tier 3 is permitted to be used in an *aggregation of units* configuration, it is generally not required for configurations of this type because Tier 3 is only required for certain units larger than 250 mmBtu/hr. Units of that size may not be included in the *aggregation of units* configuration.

➡ See [Section 2.3](#) for instructions on how to report for Configuration Type 3.

**Configuration Type 4 – Common Pipe [98.36(c)(3)]**

The *common pipe* reporting configuration is another alternative reporting option that allows for multiple units to be reported as a single group entry.

This configuration is different from the *aggregation of units* configuration in that there is no size constraint. The *common pipe* configuration may only be used if two or more stationary combustion units at a facility combust the same type of liquid or gaseous fuel, and the fuel is fed to the individual units through a common supply line or pipe.

The *common pipe* configuration may only be used if the units only combust the liquid or gaseous fuel supplied by the common pipe. Units that combust fuel other than the fuel supplied by the common pipe must be accounted for under a separate configuration. For example, a unit that burns coal and natural gas may not be included in a *common pipe* configuration for units that only combust natural gas. In such a situation, you may report the units that only combust natural gas as a common pipe configuration. To calculate emissions for the common pipe, you would subtract the quantity of diverted gas (i.e. gas combusted at a coal unit) from the quantity of gas measured for the common pipe by using company records. The diverted gas would need to be accounted for in a separate configuration (unless not combusted or combusted in an exempt unit).

The tier required for the common pipe configuration is based on the maximum rated heat input capacity of the largest unit served by the common pipe.

➡ See [Section 2.4](#) for instructions on how to report for Configuration Type 4.

#### **Configuration Type 5 – Common Stack [98.36(c)(2)]**

If multiple units vent to a common stack or duct and Tier 4 is used to calculate the CO<sub>2</sub> emissions for those units, the *common stack* configuration must be used. If only a single combustion unit vents to the stack and no process units are vented to the stack, then Configuration Type 2 (single unit using Tier 4) must be used.

➡ See [Section 2.5](#) for instructions on how to report for Configuration Type 5.

#### **Configuration Type 6 – Alternative Part 75 Reporters [98.36(d)(2)]**

This configuration represents the alternative calculation and reporting requirements available to certain units that report heat input year-round to EPA according to part 75. Units subject to Subpart D (electricity generating units that are subject to the Acid Rain Program or EGUs that are otherwise required to monitor and report to EPA CO<sub>2</sub> emissions year-round according to Part 75) are not eligible to report under this option. Units subject to Subpart D should report following the instructions for Subpart D.

If this option is selected in place of using one of the four tiers, the applicable calculation methodology specified in 98.33(a)(5) must be used to calculate CO<sub>2</sub> emissions and the reporting requirements specified in 98.36(d)(2) replace the requirements specified in 98.36(a)-(b).

➡ See [Section 2.6](#) for instructions on how to report for Configuration Type 6.

## 2.1 Configuration Type 1 Identification

Specific data components are required for Configuration Type 1. See the relevant components boxed in red in the figure below.

**Figure 10**  
**Units C Details for Configuration Type 1 Schema Diagram**

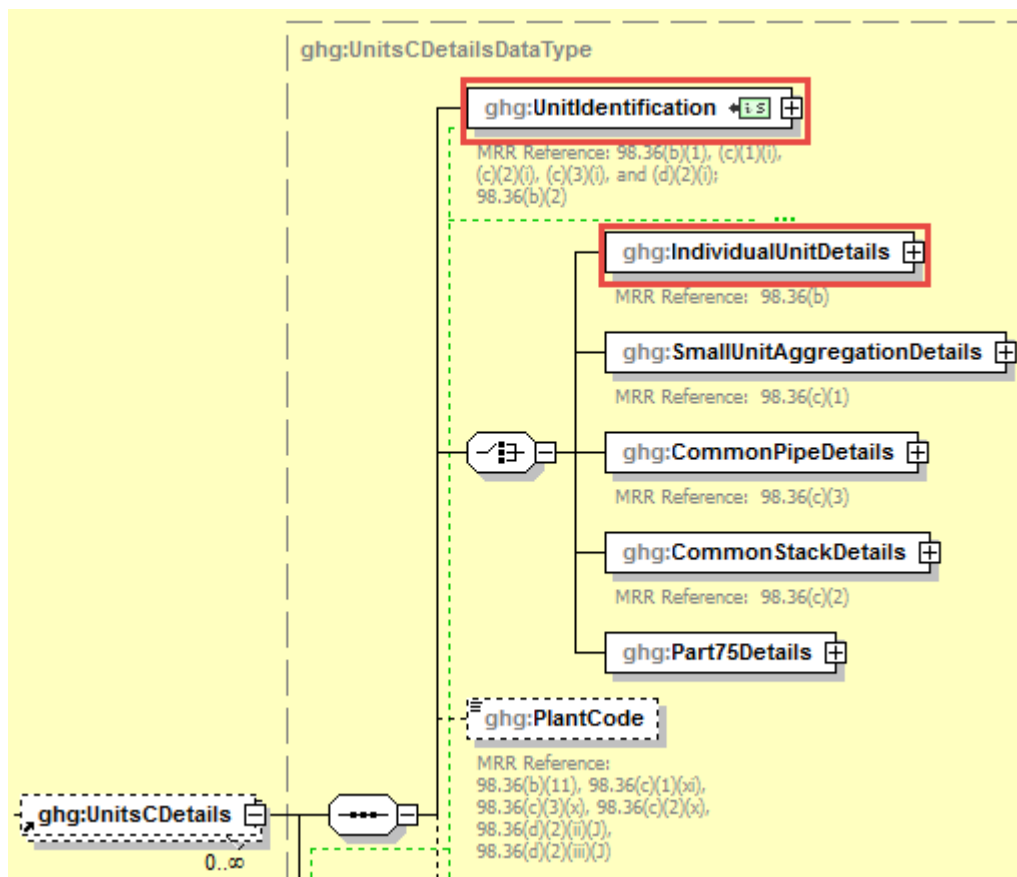

**Note:** Data elements boxed in red are required.

Each single unit using Tiers 1, 2 or 3 to calculate emissions must be identified separately so that emissions information can be reported for a specific unit.

If a single unit switches from using Tiers 1-3 to Tier 4 during the year, a new configuration of Configuration Type 2 must be added to represent the period in which Tier 4 was used. Different unit names would need to be used for the two configurations even though the configurations are representing the same unit. Do not use quotes, apostrophes, or commas in unit names.

**Figure 11**  
**Configuration Type 1 Unit Identification Schema Diagram**

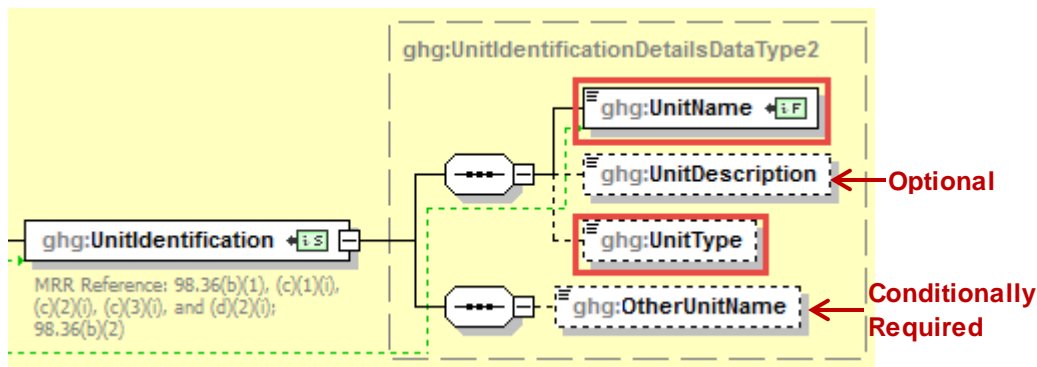

**Note:** Data elements boxed in red are required. Please see page 4 of this document for more information on conditionally required elements.

For configurations of **Type 1 (single unit using Tiers 1, 2 or 3)**, Subpart C requires the following identification information for each configuration:

- A unique unit name or identifier (e.g., a unit ID number) [98.36(b)(1)]
- An optional unit description or label [optional]
- A code representing the type of unit [98.36(b)(2)]

**Table 6**  
**Configuration Type 1 Unit Identification Data Element Definitions**

Data Element Name	Description
<b>UnitsCDetails</b>	<b>Parent Element:</b> A collection of data elements containing details regarding each stationary fuel combustion unit configuration.
<b>UnitIdentification</b>	<b>Parent Element:</b> A collection of data elements containing the identity of each Subpart C reporting configuration.
UnitName	A user-defined identifier for this unit. Each unit or configuration must have a unique UnitName. [98.36(b)(1)]. Alphanumeric and most special characters may be used. Do not use quotes, apostrophes, or commas.
UnitDescription	An optional description or label.
UnitType	A code representing the type of unit. See the list of allowable unit type codes below. If the unit type is not provided in the list, report “OCS (Other combustion source)” and report the unit type using the OtherUnitName element. [98.36(b)(2)] See list of allowable values:  PCWD (Pulverized coal, wall-fired, dry bottom) PCWW (Pulverized coal, wall-fired, wet bottom) PCT (Pulverized coal, tangentially-fired)

Data Element Name	Description
	PCO (Pulverized coal, other) CF (Cyclone Furnace) S (Stoker Boiler) BFB (Boiler, bubbling fluidized bed) CFB (Boiler, circulating fluidized bed) PFB (Boiler, pressurized fluidized bed) OFB (Fluidized bed, other) OB (Boiler, other) FLR (Flare) II (Incinerator, institutional) ICI (Incinerator, commercial and industrial) IGCC (Integrated gasification combined cycle) RICE (Reciprocating internal combustion engine) MWC (Municipal waste combustor) PRH (Process Heater) TODF (Thermal oxidizer, direct fired, no heat recovery) RTO (Regenerative thermal oxidizer) RCO (Regenerative catalytic oxidizer) CCCT (CC (Turbine, combined cycle)) SCCT (CT (Turbine, simple cycle combustion)) CH (Comfort heater) PD (Product or intermediate product dryer) K (Kiln) F (Furnace) C (Calciner) O (Oven) HWH (Heater, hot water) IFCE (Direct fired industrial food cooking equipment) NGLH (Heater, natural gas line) CatH (Heater, catalytic) HMH (Heater, heat medium for heat exchange) COB (By-product recovery coke oven battery combustion stacks (\$98.172)) FeFS (Subpart Q - flame suppression) FeFL (Subpart Q - ladle reheater) Q (Other Subpart Q combustion sources not otherwise listed.) HPPU (hydrogen production process units) OCS (Other combustion source)
OtherUnitName	<b>Conditionally Required:</b> Enter the unit type if "OCS (Other combustion source)" was entered for UnitType. Otherwise, do not report this element.

### XML Excerpt 3 Example for Configuration Type 1 Unit Identification

```

<ghg:UnitsCDetails>
  <ghg:UnitIdentification>
    <ghg:UnitName>CT 1 - Tier 1 </ghg:UnitName>
    <ghg:UnitDescription>Tier 1 unit</ghg:UnitDescription>
    <ghg:UnitType>OCS (Other combustion source)</ghg:UnitType>
    <ghg:OtherUnitName>Unit Type A </ghg:OtherUnitName>
  </ghg:UnitIdentification>

```

**Note:** The code excerpt above is presented here to demonstrate the concept of reporting greenhouse gas emissions data.

For individual unit details, the value of the maximum rated heat input capacity of the unit must be reported.

**Figure 12**  
**Configuration Type 1 Individual Unit Details Schema Diagram**

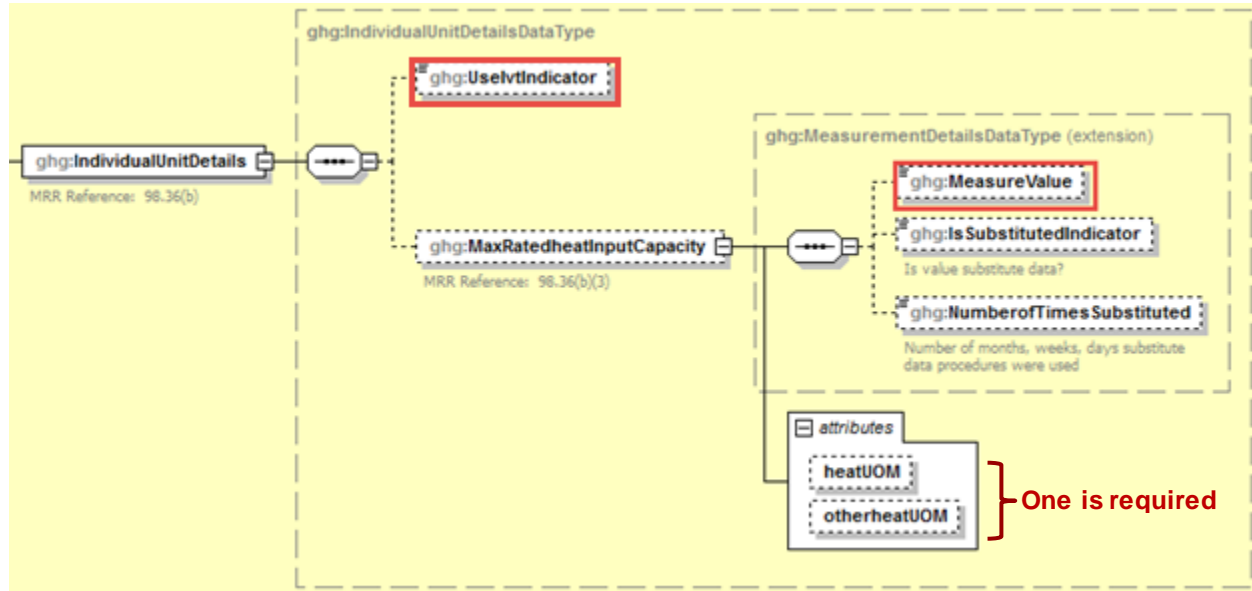

**Note:** Data elements boxed in red are required. Please see page 4 of this document for more information on conditionally required elements.

For configurations of **Type 1 (single unit using Tiers 1, 2 or 3)**, report the following:

- Whether the IVT is used
- The measured value and heat unit of measure only. For heatUOM, use mmBtu/hr. [98.36(b)(3)]

**Table 7**  
**Configuration Type 1 Individual Unit Details Data Element Definitions**

Data Element Name	Description
<b>Individual UnitDetails</b>	<b>Parent Element:</b> A collection of data elements containing details about each individual stationary combustion unit that uses one of the four tiers and that is reporting as an individual unit under 98.36(b).
UseIvtIndicator	Indicate whether inputs are being entered using the Inputs Verifier Tool (IVT).  Y N
<b>MaxRatedHeatInputCapacity</b>	<b>Parent Element:</b> Maximum rated heat input capacity of the unit. Report the value in the child data element <b>MeasureValue</b> . For reporting year 2013 and onward, you may only set the units of measure to “mmBtu/hr” in the attribute <b>heatUOM</b> . For reporting years 2010, 2011 and 2012, you may use "Other" if there is another relevant unit of measure (other than mmBtu/hr).  <b>Conditionally Required:</b> For reporting years 2010, 2011, or 2012, if "Other" was entered in the attribute <b>heatUOM</b> , report the actual unit of measure in the attribute <b>otherheatUOM</b> . Otherwise, do not report this attribute.



### XML Excerpt 4 Example for Configuration Type 1 Individual Unit Details

```
<ghg:IndividualUnitDetails>  
  <ghg:UseIvtIndicator>Y</ghg:UseIvtIndicator>  
  <ghg:MaxRatedheatInputCapacityotherheatUOM="BTU per hour">  
    <ghg:MeasureValue>1000</ghg:MeasureValue>  
  </ghg:MaxRatedheatInputCapacity>  
</ghg:IndividualUnitDetails>
```

**Note:** The code excerpt above is presented here to demonstrate the concept of reporting greenhouse gas emissions data.

➔ See [Section 3.1](#) for instructions on how to report emissions data for configuration type 1 units.

## 2.2 Configuration Type 2 Identification

Specific data components are required for Configuration Type 2. See the relevant components boxed in red in the figure below.

**Figure 13**  
**Units C Details for Configuration Type 2 Schema Diagram**

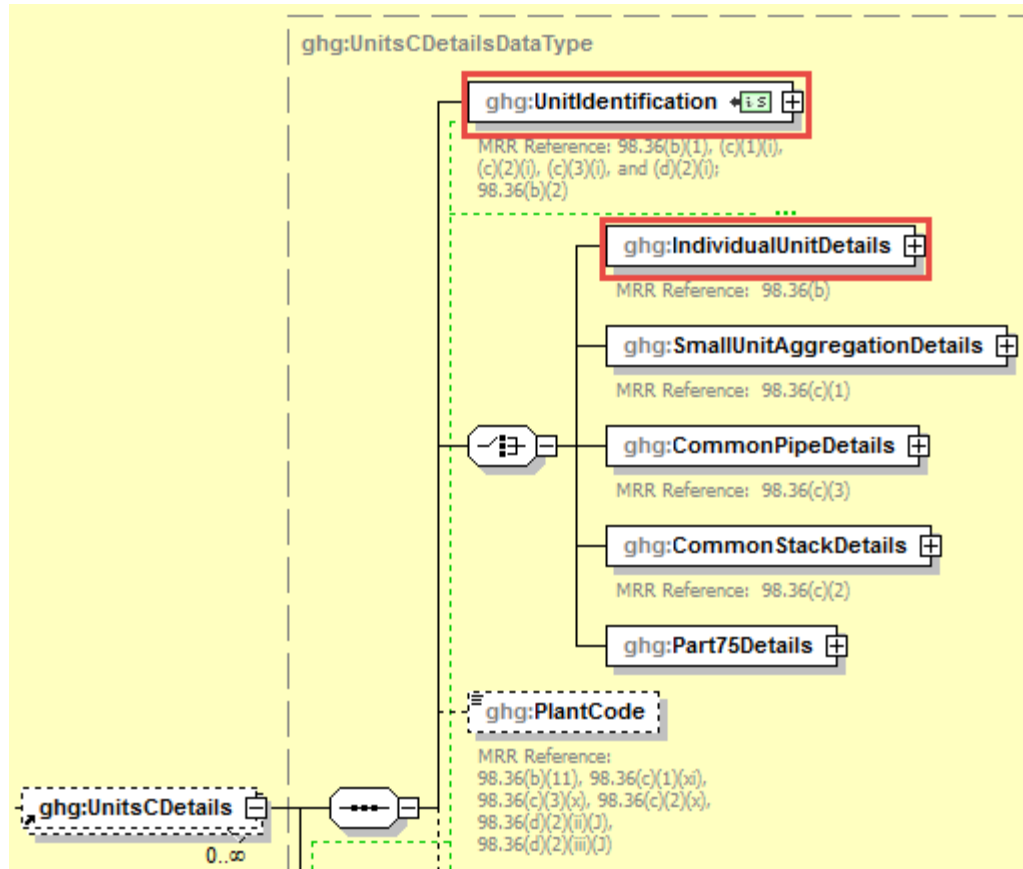

Note: Data elements boxed in red are required.

Each single unit using Tier 4 (CEMS) to calculate emissions must be identified separately so that emissions information can be reported for a specific unit.

**Figure 14**  
**Configuration Type 2 Unit Identification Schema Diagram**

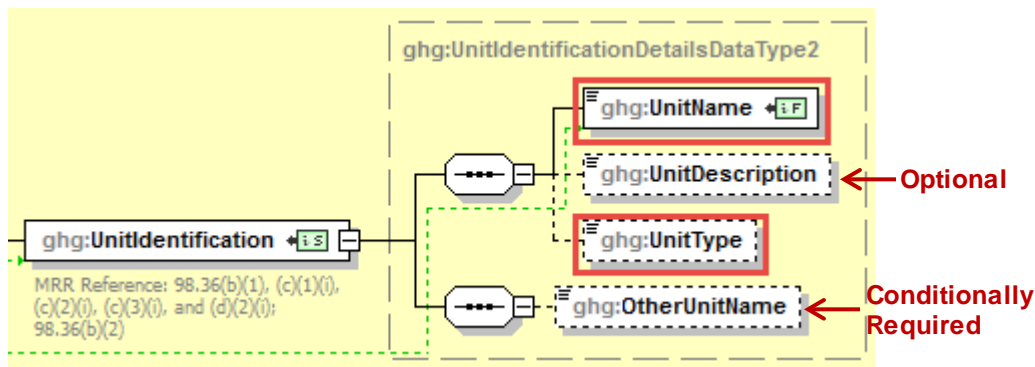

**Note:** Data elements boxed in red are required. Please see page 4 of this document for more information on conditionally required elements.

For configurations of **Type 2 (single unit using Tier 4)**, Subpart C requires the following identification information for each configuration:

- A unique unit name or identifier (e.g., a unit ID number) [98.36(b)(1)]
- An optional unit description or label [optional]
- A code representing the type of unit [98.36(b)(2)]

**Table 8**  
**Configuration Type 2 Unit Identification Data Element Definitions**

Data Element Name	Description
<b>UnitsCDetails</b>	<b>Parent Element:</b> A collection of data elements containing details regarding each stationary fuel combustion unit configuration.
<b>UnitIdentification</b>	<b>Parent Element:</b> A collection of data elements containing the identity of each Subpart C reporting configuration.
UnitName	A user-defined identifier for this unit. Each unit or configuration must have a unique UnitName. [98.36(b)(1)] Alphanumeric and most special characters may be used. Do not use quotes, apostrophes, or commas.
UnitDescription	An optional description or label.
UnitType	A code representing the type of unit. See the list of allowable unit type codes below. If the unit type is not on the list, report “OCS (Other combustion source) and then report the unit type using the OtherUnitName element. [98.36(b)(2)] See list of allowable values:  PCWD (Pulverized coal, wall-fired, dry bottom) PCWW (Pulverized coal, wall-fired, wet bottom) PCT (Pulverized coal, tangentially-fired) PCO (Pulverized coal, other) CF (Cyclone Furnace) S (Stoker Boiler) BFB (Boiler, bubbling fluidized bed)

Data Element Name	Description
	CFB (Boiler, circulating fluidized bed) PFB (Boiler, pressurized fluidized bed) OFB (Fluidized bed, other) OB (Boiler, other) FLR (Flare) II (Incinerator, institutional) ICI (Incinerator, commercial and industrial) IGCC (Integrated gasification combined cycle) RICE (Reciprocating internal combustion engine) MWC (Municipal waste combustor) PRH (Process Heater) TODF (Thermal oxidizer, direct fired, no heat recovery) RTO (Regenerative thermal oxidizer) RCO (Regenerative catalytic oxidizer) CCCT (CC (Turbine, combined cycle)) SCCT (CT (Turbine, simple cycle combustion)) CH (Comfort heater) PD (Product or intermediate product dryer) K (Kiln) F (Furnace) C (Calcliner) O (Oven) HWH (Heater, hot water) IFCE (Direct fired industrial food cooking equipment) NGLH (Heater, natural gas line) CatH (Heater, catalytic) HMH (Heater, heat medium for heat exchange) COB (By-product recovery coke oven battery combustion stacks (§98.172)) FeFS (Subpart Q - flame suppression) FeFL (Subpart Q - ladle reheater) Q (Other Subpart Q combustion sources not otherwise listed.) HPPU (hydrogen production process units) OCS (Other combustion source)
OtherUnitName	<b>Conditionally Required:</b> Enter the unit type if "OCS (Other combustion source)" was entered for UnitType. Otherwise, do not report this attribute.

**XML Excerpt 5**  
**Example for Configuration Type 2 Unit Identification**

```

<ghg:UnitsCDetails>
  <ghg:UnitIdentification>
    <ghg:UnitName>CT 2 - Tier 4 </ghg:UnitName>
    <ghg:UnitDescription>Tier 4 unit</ghg:UnitDescription>
    <ghg:UnitType>F (Furnace)</ghg:UnitType>
  </ghg:UnitIdentification>

```

**Note:** The code excerpt above is presented here to demonstrate the concept of reporting greenhouse gas emissions data.

For individual unit details, the value of the maximum rated heat input capacity of the unit must be reported.

**Figure 15**  
**Configuration Type 2 Individual Unit Details Schema Diagram**

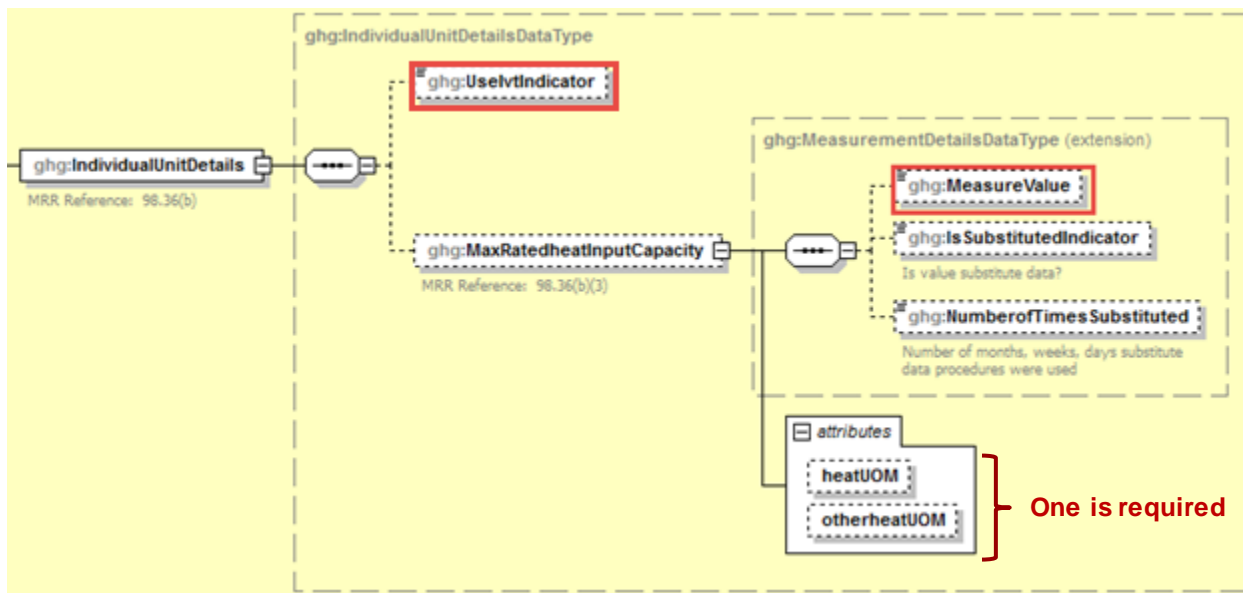

**Note:** Data elements boxed in red are required. Please see page 4 of this document for more information on conditionally required elements.

For configurations of **Type 2 (single unit using Tier 4)**, report the following:

- Whether the IVT is used
- The measured value and heat unit of measure only. For heatUOM, use mmBtu/hr for reporting year 2013 and onward. For reporting years 2010, 2011 and 2012, enter "Other" if there is another relevant unit of measure for other combustion sources, and enter the unit of measure for otherheatUOM. [98.36(b)(3)]

**Table 9**  
**Configuration Type 2 Individual Unit Details Data Element Definitions**

Data Element Name	Description
<b>Individual UnitDetails</b>	<b>Parent Element:</b> A collection of data elements containing details about each individual stationary combustion unit that uses one of the four tiers and that are reporting under 98.36(b).
UseIvtIndicator	Indicate whether inputs are being entered using the Inputs Verifier Tool (IVT).  Y N

Data Element Name	Description
<b>MaxRateHeatInputCapacity</b>	<p><b>Parent Element:</b> Maximum rated heat input capacity of the unit. Report the value in the child data element <b>MeasureValue</b>. For reporting year 2013, for boilers, process heaters, and other combustion sources, you may only set the units of measure to “mmBtu/hr” in the attribute <b>heatUOM</b>. For reporting years 2010, 2011 and 2012, you may use "Other" if there is another relevant unit of measure (other than mmBtu/hr).</p> <p><b>Conditionally Required:</b> For reporting year 2013, if the unit uses a measure other than “mmBtu/hr”, report the actual unit of measure in the attribute <b>otherheatUOM</b>. For reporting years 2010, 2011, and 2012, if "Other" was entered in the attribute <b>heatUOM</b>, report the actual unit of measure in the attribute <b>otherheatUOM</b>. Otherwise, do not report this attribute.</p>

### XML Excerpt 6 Example for Configuration Type 2 Individual Unit Details

```

<ghg:IndividualUnitDetails>
  <ghg:UseIvyIndicator>Y</ghg:UseIvtIndicator>
  <ghg:MaxRateHeatInputCapacity heatUOM="mmBtu/hr">
    <ghg:MeasureValue>4000</ghg:MeasureValue>
  </ghg:MaxRateHeatInputCapacity>

```

**Note:** The code excerpt above is presented here to demonstrate the concept of reporting greenhouse gas emissions data.

 See [Section 4.0](#) for instructions on how to report fuel data for configuration type 2 units.

### 2.3 Configuration Type 3 Identification

Specific data components are required for Configuration Type 3. See the relevant components boxed in red in the figure below.

**Figure 16**  
**Units C Details for Configuration Type 3 Schema Diagram**

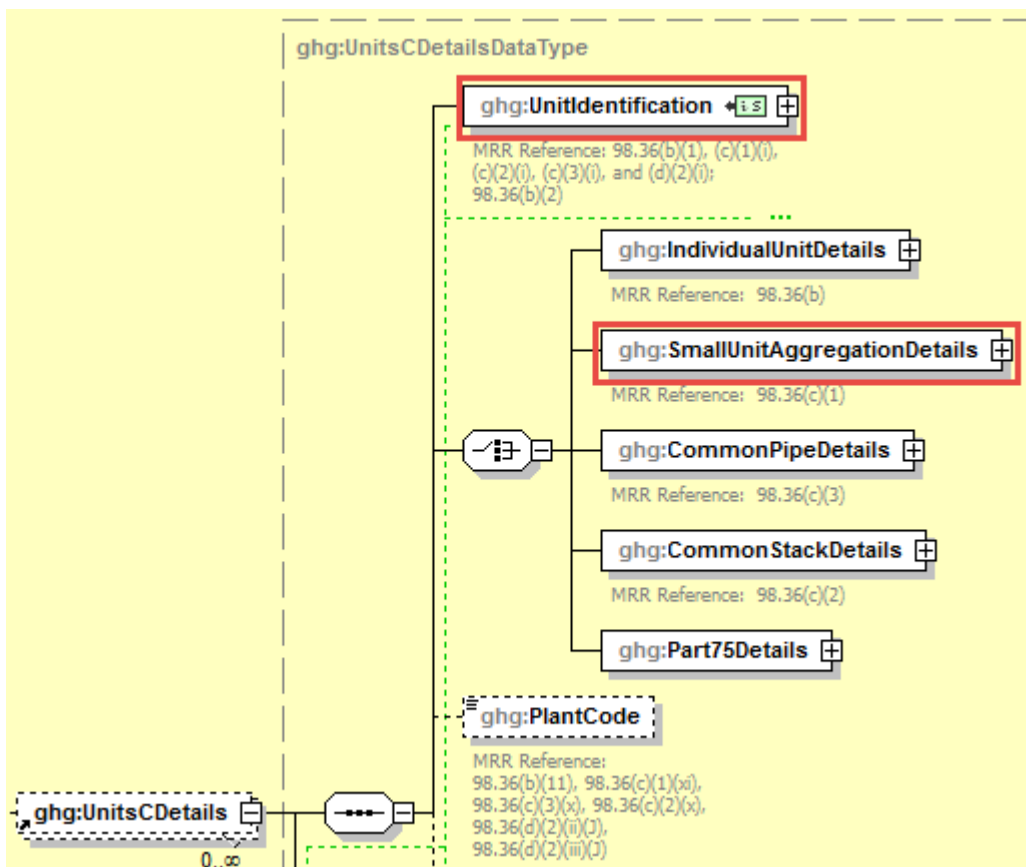

**Note:** Data elements boxed in red are required.

Each group of units using the aggregation of units reporting alternative must be identified separately so that emissions information can be reported for a specific aggregation of units.

**Figure 17**  
**Configuration Type 3 Unit Identification Schema Diagram**

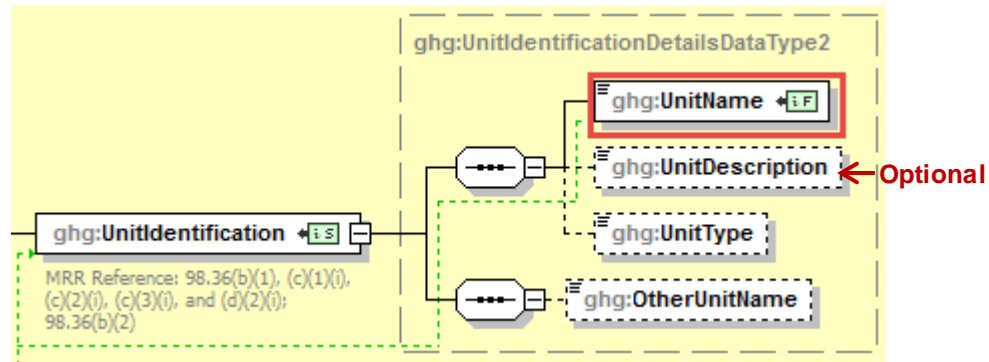

For configurations of **Type 3 (aggregation of units)**, Subpart C requires the following identification information for each configuration:

- A unique name or identifier that begins with the prefix “GP” [98.36(c)(1)(i)]
- An optional description or label [optional]

**Table 10**  
**Configuration Type 3 Unit Identification Data Element Definitions**

Data Element Name	Description
<b>UnitsCDetails</b>	<b>Parent Element:</b> A collection of data elements containing details regarding each stationary fuel combustion unit configuration.
<b>UnitIdentification</b>	<b>Parent Element:</b> A collection of data elements containing the identity of each Subpart C reporting configuration.
UnitName	A user-defined identifier for this configuration. Each unit or configuration must have a unique UnitName. For an aggregation of units configuration, report the group name/ID beginning with the prefix "GP". [98.36(c)(1)(i)]. Alphanumeric and most special characters may be used. Do not use quotes, apostrophes, or commas.
UnitDescription	An optional description or label. For example, the scope of units included in this configuration may be reported here.



### XML Excerpt 7 Example for Configuration Type 3 Unit Identification

```

<ghg:UnitsCDetails>
  <ghg:UnitIdentification>
    <ghg:UnitName>GP-CT3- Tier 1 </ghg:UnitName >
    <ghg:UnitDescription>Tier 1 units</ghg:UnitDescription >
  </ghg:UnitIdentification >
</ghg:UnitsCDetails >
    
```

**Note:** The code excerpt above is presented here to demonstrate the concept of reporting greenhouse gas emissions data.

For small unit aggregation details, the value of the highest maximum rated heat input capacity of any unit of the group must be reported.

**Figure 18  
Small Unit Aggregation Details Schema Diagram**

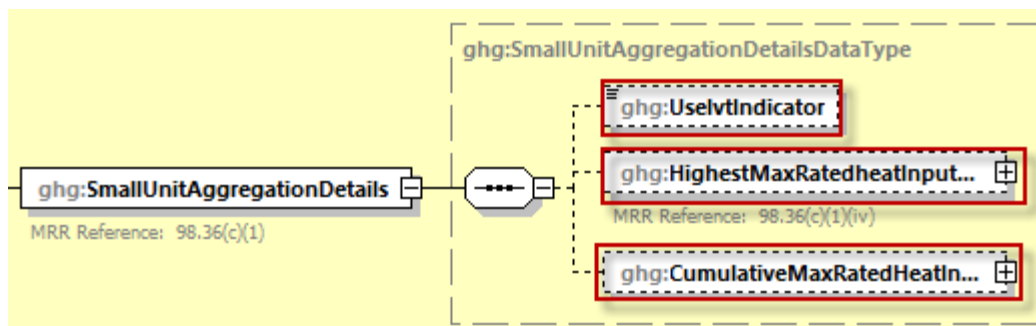

**Note:** Data elements boxed in red are required.

For configurations of **Type 3 (aggregation of units)**, report the following:

- Whether the IVT is used
- The highest maximum rated heat input capacity of any unit in the group including the measured value and heat unit of measure in mmBtu/hr only. [98.36(c)(1)(iv)]
- The cumulative maximum rated heat input capacity of for all units within the configuration that have a maximum rated heat input capacity greater than or equal to 10 mmBtu/hr including the measured value and heat unit of measure in mmBtu/hr only. [98.36(c)(1)(iv)]

**Table 11  
Small Unit Aggregation Details Data Element Definitions**

Data Element Name	Description
<b>SmallUnitAggregationDetails</b>	<b>Parent Element:</b> A collection of data elements containing details about an aggregation of units reporting under 98.36(c)(1) as an aggregation of units configuration.
UseIvtIndicator	Indicate whether inputs are being entered using the Inputs Verifier Tool (IVT).

	Y N
<b>HighestMaxRatedHeatInputCapacity</b>	<b>Parent Element:</b> The highest maximum rated heat input capacity of any unit in the group (aggregation of units configuration). Report the value in the child data element <b>MeasureValue</b> . Set the units of measure to “mmBtu/hr” in the attribute <b>heatUOM</b> . [98.36(c)(1)(iv)]
<b>CumulativeMaxRatedHeatInputCapacity</b>	<b>Parent Element:</b> For RY2017 and later report “Cumulative maximum rated heat input capacity of for all units within the configuration that have a maximum rated heat input capacity greater than or equal to 10 mmBtu/hr “mmBtu/hr” in the attribute <b>heatUOM</b> . [98.36(c)(1)(iv)]

### XML Excerpt 8 Example for Small Unit Aggregation Details

```

<ghg:SmallUnitAggregationDetails>
  <ghg:UseIvtIndicator>Y</ghg:UseIvtIndicator>
  <ghg:HighestMaxRatedHeatInputCapacity heatUOM="mmBtu/hr">
    <ghg:MeasureValue>5000</ghg:MeasureValue>
  </ghg:HighestMaxRatedHeatInputCapacity>
  <ghg:CumulativeMaxRatedHeatInputCapacity heatUOM="mmBtu/hr">
    <ghg:MeasureValue>7500</ghg:MeasureValue>
  </ghg:CumulativeMaxRatedHeatInputCapacity>
</ghg:SmallUnitAggregationDetails>
    
```

**Note:** The code excerpt above is presented here to demonstrate the concept of reporting greenhouse gas emissions data.

The next step is to report emissions data for the configuration identified by referring to Section 3.2.

 See [Section 3.2](#) for instructions on how to report emissions data for configuration type 3 units.

## 2.4 Configuration Type 4 Identification

Specific data components are required for Configuration Type 4. See the relevant components boxed in red in the figure below.

**Figure 19**  
Units C Details for Configuration Type 4 Schema Diagram

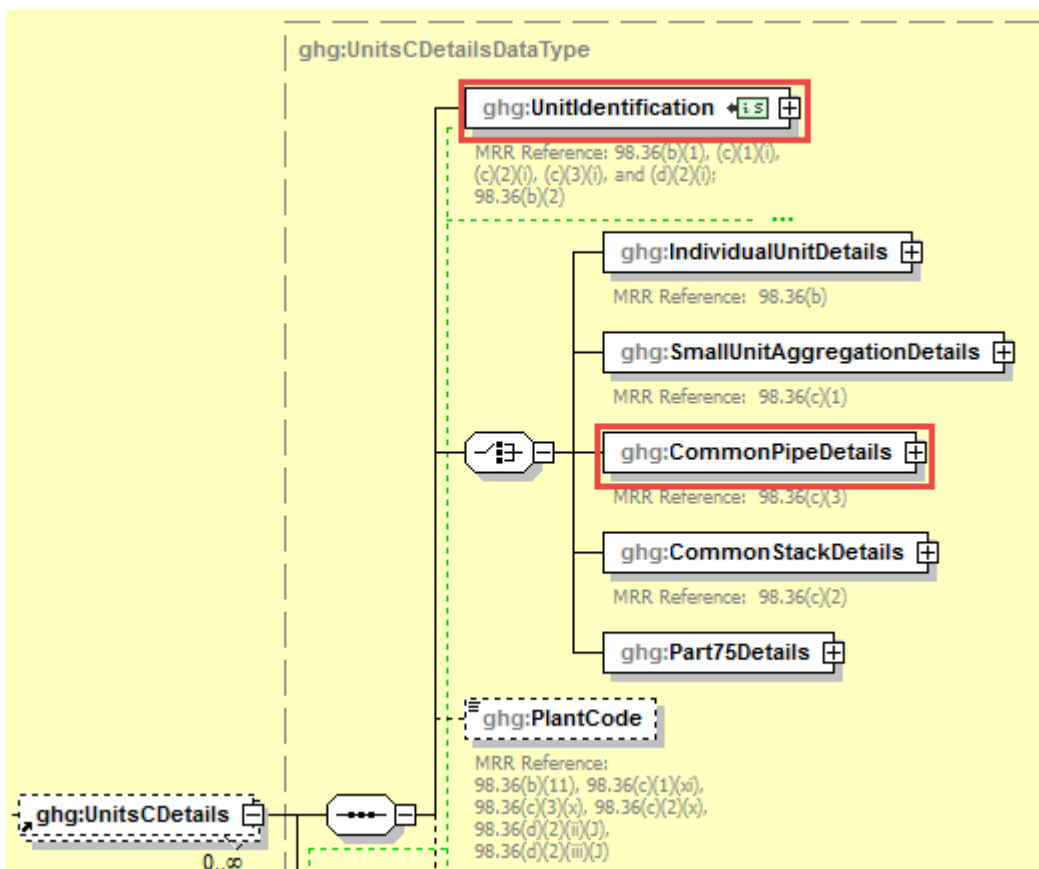

**Note:** Data elements boxed in red are required.

Each group of units using the common pipe configuration reporting alternative must be identified separately so that emissions information can be reported for a specific group of units.

**Figure 20**  
**Configuration Type 4 Unit Identification Schema Diagram**

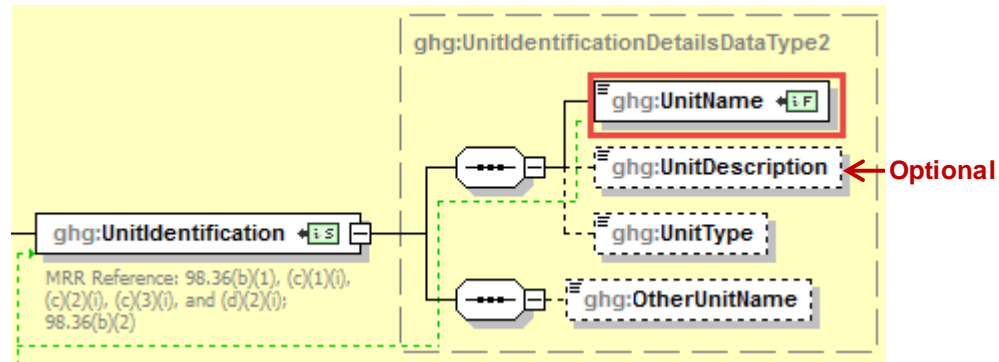

For configurations of **Type 4 (common pipe configurations)**, Subpart C requires the following identification information for each configuration:

- A unique name or identifier that begins with the prefix “CP” [98.36(c)(3)(i)]
- An optional description or label [optional]

**Table 12**  
**Configuration Type 4 Unit Identification Data Element Definitions**

Data Element Name	Description
<b>Units CDetails</b>	<b>Parent Element:</b> A collection of data elements containing details regarding each stationary fuel combustion unit configuration.
<b>UnitIdentification</b>	<b>Parent Element:</b> A collection of data elements containing the identity of each Subpart C reporting configuration.
UnitName	A user-defined identifier for this configuration. Each configuration must have a unique UnitName. For common pipe configurations, report the common pipe name/ID beginning with the prefix "CP". [98.36(c)(3)(i)]. Alphanumeric and most special characters may be used. Do not use quotes, apostrophes, or commas.
UnitDescription	An optional description or label. For example, the scope of units included in this configuration may be reported here.

## XML Excerpt 9 Example for Configuration Type 4 Unit Identification

```

<ghg:UnitsCDetails>
  <ghg:UnitIdentification>
    <ghg:UnitName>CP-CT 4 - Tier 2 </ghg:UnitName>
    <ghg:UnitDescription>Tier 2 unit</ghg:UnitDescription>
  </ghg:UnitIdentification>

```

**Note:** The code excerpt above is presented here to demonstrate the concept of reporting greenhouse gas emissions data

For common pipe details, the value of the highest maximum rated heat input capacity of any unit served by the common pipe must be reported.

**Figure 21  
Common Pipe Details Schema Diagram**

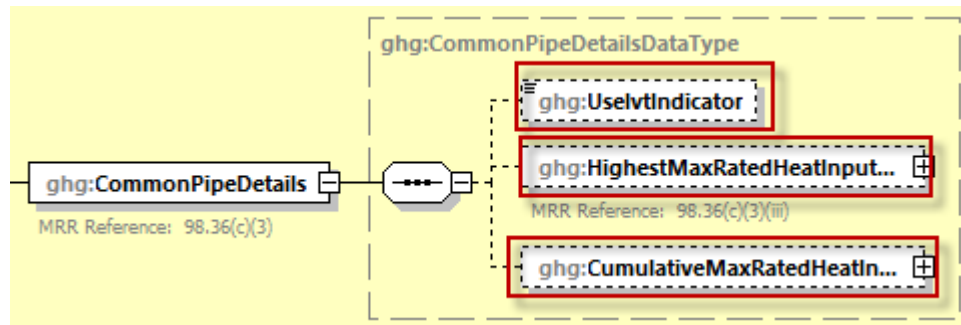

**Note:** Data elements boxed in red are required.

For configurations of Type 4 (common pipe configurations), the following is reported:

- Whether the IVT is used
- The highest maximum rated heat input capacity of any unit served by the common pipe including the measured value and heat unit of measure in mmBtu/hr only. [98.36(c)(1)(iv)]
- The cumulative maximum rated heat input capacity of for all units within the configuration that have a maximum rated heat input capacity greater than or equal to 10 mmBtu/hr including the measured value and heat unit of measure in mmBtu/hr only.

**Table 13  
Common Pipe Details Data Element Definitions**

Data Element Name	Description
<b>CommonPipeDetails</b>	<b>Parent Element:</b> A collection of data elements containing details about units reporting under 98.36(c)(3) as a common pipe configuration.
UseIvtIndicator	Indicate whether inputs are being entered using the Inputs Verifier Tool (IVT).  Y or N
<b>HighestMaxRatedHeatInputCapacity</b>	<b>Parent Element:</b> The highest maximum rated heat input capacity of any unit served by the common pipe (common pipe unit configuration). Report the value in the child data element <b>MeasureValue</b> . Set the units of measure to “mmBtu/hr” in the attribute <b>heatUOM</b> . [98.36(c)(3)(iii)]
<b>CumulativeMaxRatedHeatInputCapacity</b>	<b>Parent Element:</b> For RY2017 and later report “Cumulative maximum rated heat input capacity of for all units within the configuration that have a maximum rated heat input capacity greater than or equal to 10 mmBtu/hr “mmBtu/hr” in the attribute <b>heatUOM</b> . [98.36(c)(1)(iv)]

**XML Excerpt 10  
Example for Common Pipe Details**

```

<ghg:CommonPipeDetails>
  <ghg:UseIvtIndicator>Y</ghg:UseIvtIndicator>
  <ghg:HighestMaxRatedHeatInputCapacity heatUOM="mmBtu/hr">
    <ghg:MeasureValue>5000</ghg:MeasureValue>
  </ghg:HighestMaxRatedHeatInputCapacity>
  <ghg:CumulativeMaxRatedHeatInputCapacity heatUOM="mmBtu/hr">
    <ghg:MeasureValue>7500</ghg:MeasureValue>
  </ghg:CumulativeMaxRatedHeatInputCapacity>
</ghg:CommonPipeDetails>
    
```

**Note:** The code excerpt above is presented here to demonstrate the concept of reporting greenhouse gas emissions data.

 See [Section 3.3](#) for instructions on how to report emissions data for configuration type 4 units

## 2.5 Configuration Type 5 Identification

Specific data components are required for Configuration Type 5. See the relevant components boxed in red in the figure below.

**Figure 22**  
**Units C Details for Configuration Type 5 Schema Diagram**

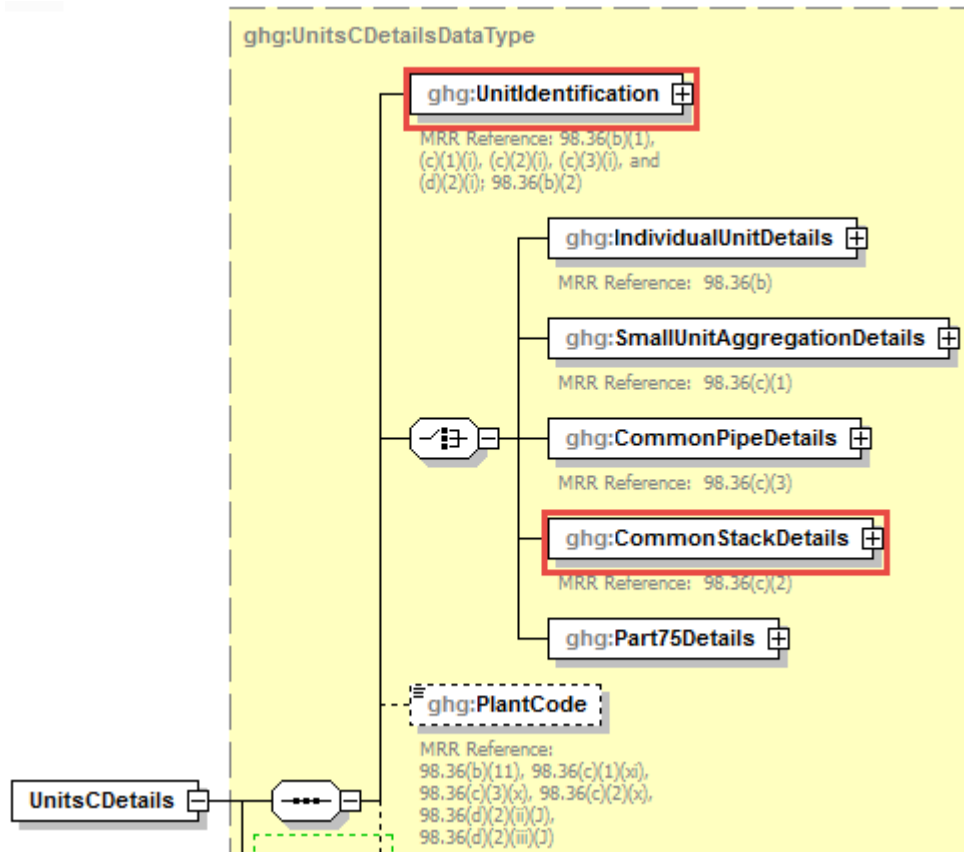

**Note:** Data elements boxed in red are required.

Each group of units using Tier 4 (CEMS) to calculate emissions and reporting under the monitored common stack or duct configurations reporting alternative must be identified separately so that emissions information can be reported for a specific group of units.

**Figure 23**  
**Configuration Type 5 Unit Identification Schema Diagram**

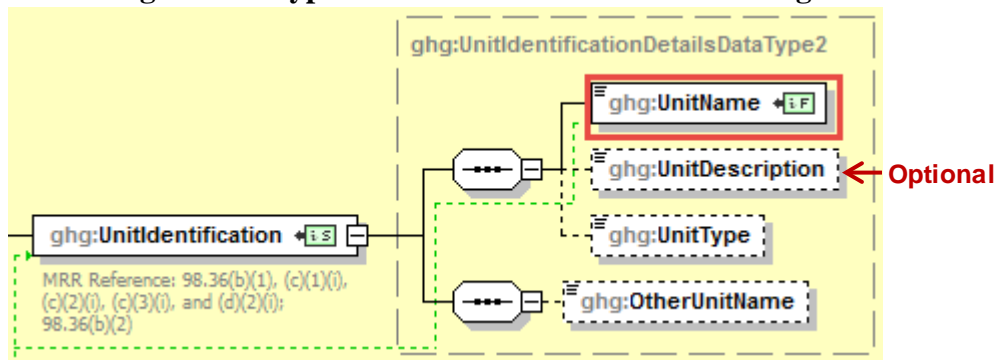

**Note:** Data elements boxed in red are required.

For configurations of **Type 5 (monitored common stack or duct configurations)**, Subpart C requires the following identification information for each configuration:

- A unique name or identifier that begins with the prefix “CS” [98.36(c)(2)(i)]
- An optional description or label [optional]

**Table 14**  
**Configuration Type 5 Unit Identification Data Element Definitions**

Data Element Name	Description
<b>UnitsCDetails</b>	<b>Parent Element:</b> A collection of data elements containing details regarding each stationary fuel combustion unit configuration.
<b>UnitIdentification</b>	<b>Parent Element:</b> A collection of data elements containing the identity of each Subpart C reporting configuration.
UnitName	A user-defined identifier for this configuration. Each configuration must have a unique UnitName. For common stack configurations, report the common stack name/ID beginning with the prefix "CS". [98.36(c)(2)(i)]. Alphanumeric and most special characters may be used. Do not use quotes, apostrophes, or commas.
UnitDescription	An optional description or label. For example, the scope of units included in this configuration may be reported here.



### XML Excerpt 11 Example for Configuration Type 5 Unit Identification

```

<ghg:UnitsCDetails>
  <ghg:UnitIdentification>
    <ghg:UnitName>CS-CT 5 - Tier 4 </ghg:UnitName>
    <ghg:UnitDescription>Tier 4 unit</ghg:UnitDescription>
  </ghg:UnitIdentification>

```

**Note:** The code excerpt above is presented here to demonstrate the concept of reporting greenhouse gas emissions data.

For the combined maximum rated heat input capacity, report the measured value and heat unit of measure in mmBtu/hr only.

**Figure 24  
Common Stack Details Schema Diagram**

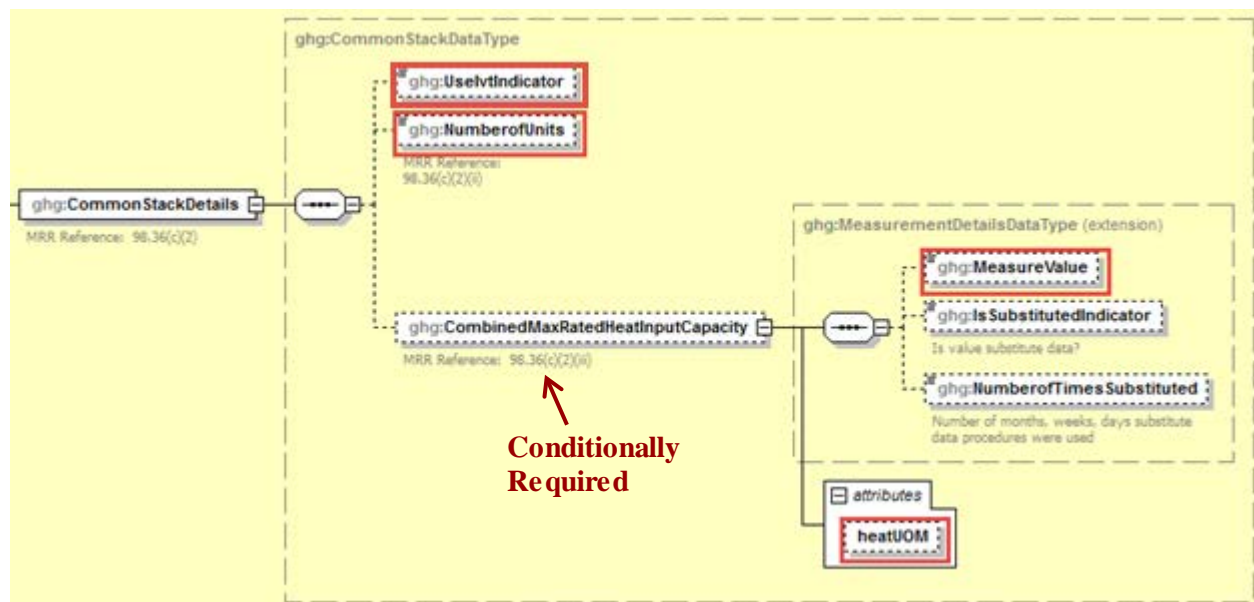

**Note:** Data elements boxed in red are required. Please see page 4 of this document for more information on conditionally required elements.

For configurations of Type 5 (monitored common stack or duct configurations) the following information must be reported:

- Whether IVT is used
- The number of units sharing the common stack [98.36(c)(2)(ii)]

The combined maximum rated heat input capacity of the units sharing the common stack in mmBtu/hr [98.36(c)(2)(iii)]

**Table 15  
Common Stack Details Data Element Definitions**

Data Element Name	Description
<b>CommonStackDetails</b>	<b>Parent Element:</b> A collection of data elements containing details about units reporting under 98.36(c)(2) as a common stack or duct configuration.
UseIvtIndicator	Indicate whether inputs are being entered using the Inputs Verifier Tool (IVT).  Y N
NumberofUnits	Number of units sharing the common stack or duct. Report “1” when the flue gas flowing through the stack includes combustion products and/or process off-gases and all of the effluent comes from a single unit. [98.36(c)(2)(ii)]
<b>CombinedMaxRatedHeatInputCapacity</b>	<b>Parent Element:</b> Combined maximum rated heat input capacity of the units sharing the common stack or duct.  <b>Conditionally Required:</b> This data element is required only when all of the units sharing the common stack are stationary fuel combustion units (monitored common stack or duct configuration). Report the value in the child data element <b>MeasureValue</b> . Set the units of measure to “mmBtu/hr” in the attribute <b>heatUOM</b> . [98.36(c)(2)(iii)]

**XML Excerpt 12  
Example for Common Stack Details**

```

<ghg:CommonStackDetails>
  <ghg:UseIvtIndicator>Y</ghg:UseIvtIndicator>
  <ghg:NumberofUnits>7</ghg:NumberofUnits>
  <ghg:CombinedMaxRatedHeatInputCapacity heatUOM="mmBtu/hr">
    <ghg:MeasureValue>7000</ghg:MeasureValue>
  </ghg:CombinedMaxRatedHeatInputCapacity>
</ghg:CommonStackDetails>
    
```

**Note:** The code excerpt above is presented here to demonstrate the concept of reporting greenhouse gas emissions data.

 See [Section 4.0](#) for instructions on how to report fuel data for the configuration identified.

## 2.6 Configuration Type 6 Identification

Specific data components are required for Configuration Type 6. See the relevant components boxed in red in the figure below.



*Have you previously filed a report with Part 75 data (for reporting year 2010, 2011, 2012, or 2013)?*

*If yes, please note that the placement of Part75Details data elements has been moved in the current version of the schema, so you must modify your XML file structure to reflect the revised location.*

**Figure 25**  
**Units C Details for Configuration Type 6 Schema Diagram**

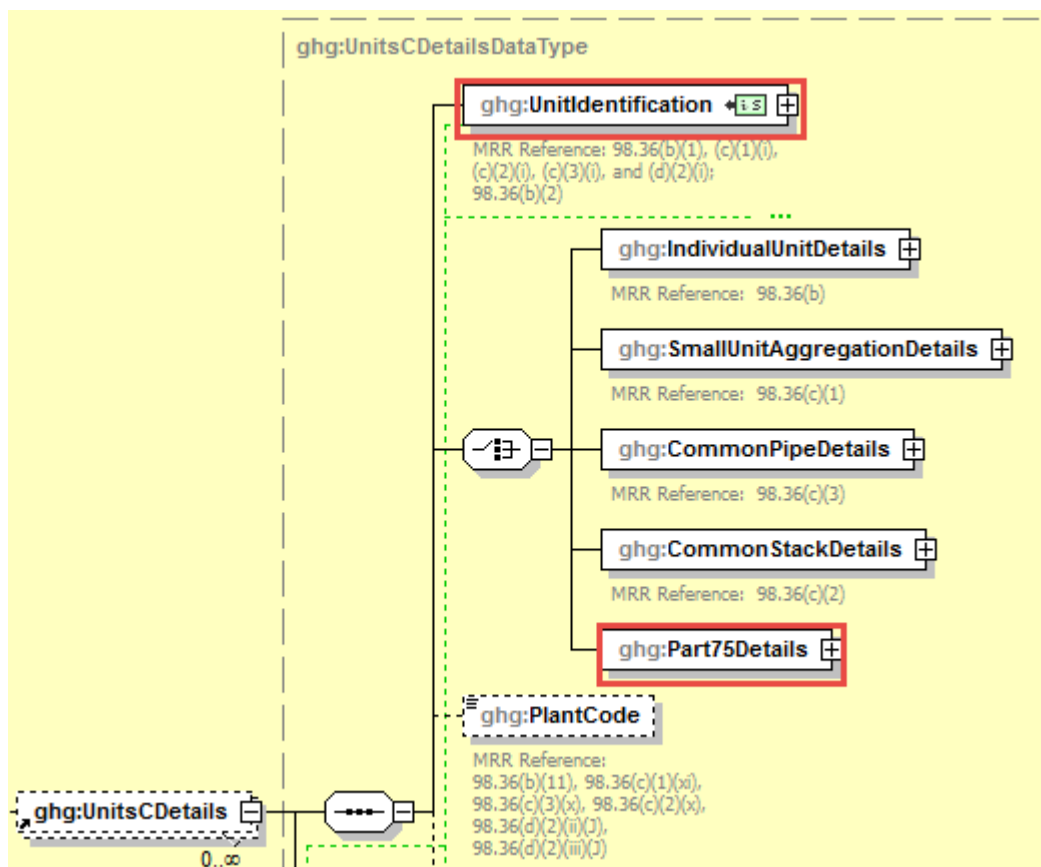

**Note:** Data elements boxed in red are required.

Each unit, stack or pipe using the alternative CO<sub>2</sub> mass emissions calculation methods provided in 98.33(a)(5) must be identified separately so that emissions information can be reported for the respective unit, stack or pipe.

**Figure 26**  
**Configuration Type 6 Unit Identification Schema Diagram**

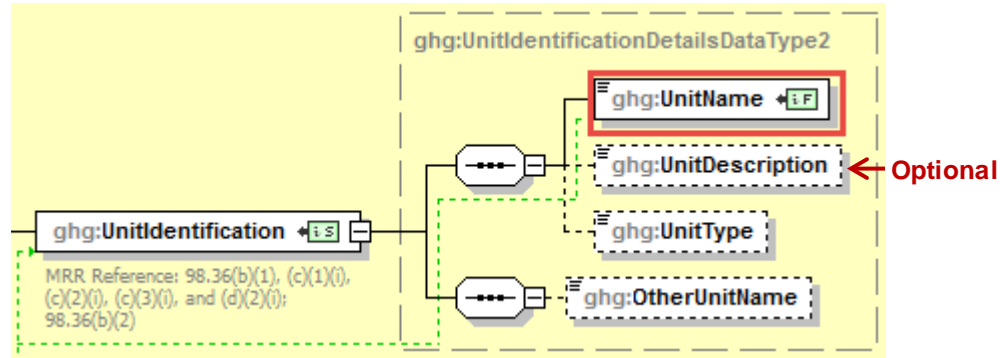

**Note:** Data elements boxed in red are required.

For configurations of **Type 6 (year-round Part 75 heat input reporters)**, Subpart C requires the following identification information for each configuration:

- Unit, stack or pipe ID numbers. Use the exact same unit, common stack, common pipe or multiple stack identification numbers that represent the monitored locations ( e.g., 1, 2, CS001, MS1A, CP001, etc. ) that are reported under 40 CFR 75.64 [98.36(d)(2)(i)]
- An optional description or label [optional]

**Table 16**  
**Configuration Type 6 Unit Identification Data Element Definitions**

Data Element Name	Description
<b>UnitsCDetails</b>	<b>Parent Element:</b> A collection of data elements containing details regarding each stationary fuel combustion unit configuration.
<b>UnitIdentification</b>	<b>Parent Element:</b> A collection of data elements containing the identity of each Subpart C reporting configuration.
UnitName	For part 75 units, use exactly the same name/ID that is reported under §75.64 and that represents the monitored location. [98.36(d)(2)(i)]. Alphanumeric and most special characters may be used. Do not use quotes, apostrophes, or commas.
UnitDescription	An optional description or label. For example, the scope of units included in this configuration may be reported here.

**XML Excerpt 13**  
**Example for Configuration Type 6 Unit Identification**

```
<ghg:UnitsCDetails>
  <ghg:UnitIdentification>
    <ghg:UnitName>CT 6 - C EMS</ghg:UnitName>
    <ghg:UnitDescription>Part 75 unit</ghg:UnitDescription>
  </ghg:UnitIdentification>
</ghg:UnitsCDetails>
```

**Note:** The code excerpt above is presented here to demonstrate the concept of reporting greenhouse gas emissions data.

➡ See [Section 3.4](#) for instructions on how to report emissions data for configuration type 6 units.

## 2.7 Configuration Plant Code

This section of the Subpart C XML reporting instructions covers requirements for reporting the Plant Code associated with the unit. Plant Code is a required data element for reporting years 2013 onward for Configuration Types 1 through 6. (98.36(b)(11), 98.36(c)(1)(xi), 98.36(c)(2)(xi), 98.36(c)(3)(x), 98.36(d)(1)(x), 98.36(d)(2)(ii)(J), and 98.36(d)(2)(iii)(J))

**?** *Is there a Plant ID code assigned by the Department of Energy’s Energy Information Administration (also referred to as the “ORIS code”, “ORISPL code”, “Facility ID”, or “Facility code”, among other names.) associated with your unit?*

*If yes, use this Plant ID code as the PlantCode for your unit.*

*If no, use the code beginning with “88” assigned by the EPA’s Clean Air Markets Division for electronic reporting as the PlantCode for your unit.*

**Figure 27**  
**Configuration Plant Code Schema Diagram**

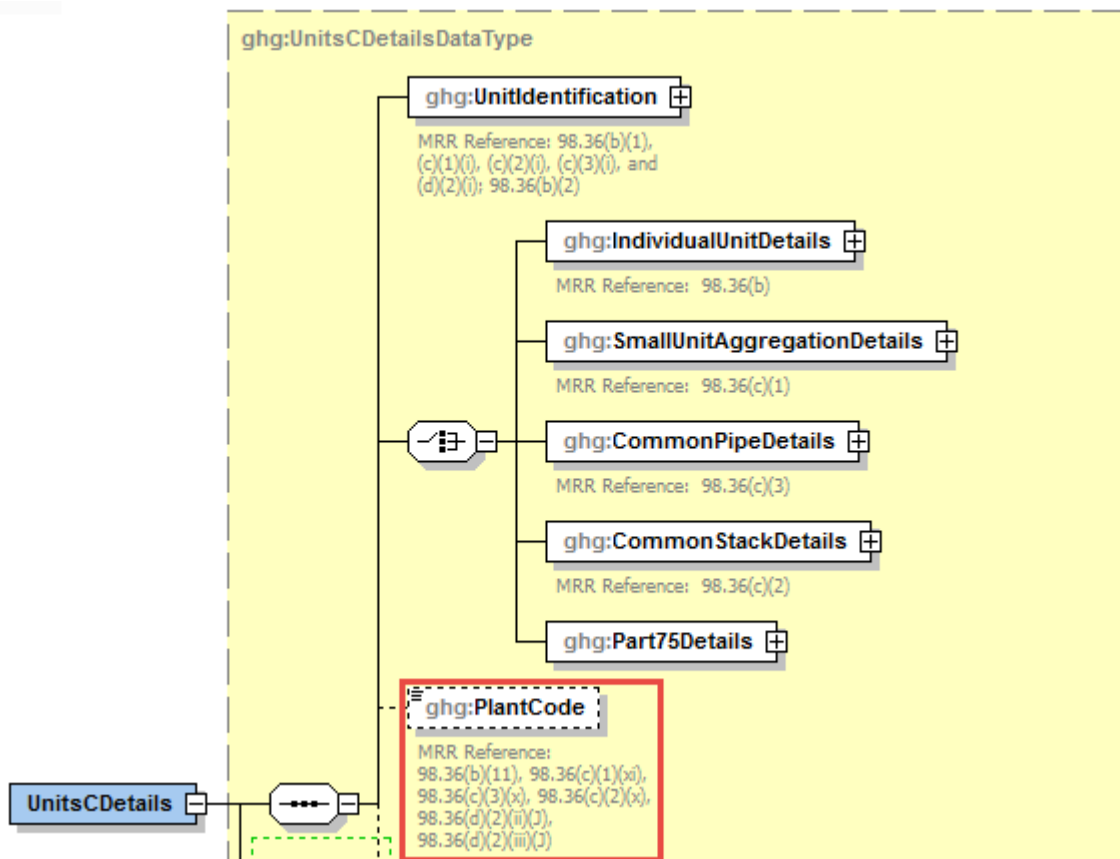

**Note:** Data elements boxed in red are required.

**Table 17**  
**Configuration Plant Code Data Element Definitions**

Data Element Name	Description
<b>UnitsCDetails</b>	<b>Parent Element:</b> A collection of data elements containing details regarding each stationary fuel combustion unit configuration.
PlantCode	The Plant ID associated with the unit (98.6). This code must be a six-digit integer. Multiple comma delimited plant codes may be included.

**XML Excerpt 14**  
**Example for Configuration Type 1 Configuration Level Emissions**

```

<ghg:SubpartC >
...
  <ghg:PlantCode>881111,881112</ghg:PlantCode >
...
</ghg:SubpartC >

```

### 3.0 Configuration Level Emissions Information

This section of the Subpart C XML reporting instructions covers the requirements for reporting the configuration level emissions information, such as total sorbent emissions, total biogenic emissions and total fossil fuel emissions.

**Note:** The schema is ordered such that data elements for reporting configuration level emissions data are placed in two areas within the schema structure. Section 3.0 covers the configuration level emissions information referenced above in the first paragraph on this page. [Section 5.0](#) covers the following additional configuration level information requirements (see figure below):

- Biogenic CO<sub>2</sub> verification data. This applies to configuration types 1-5.
- Tier 4 details. This applies to configuration types 2 and 5.

[Section 4](#) of these instructions describes the requirements for reporting fuel-specific emissions. Note that the reporting of both configuration-level and fuel-specific emissions are required for all configurations types. Also, as with the identification information, each configuration has unique reporting requirements for emissions information.

**Figure 28**  
**Configuration Level Emissions Data**

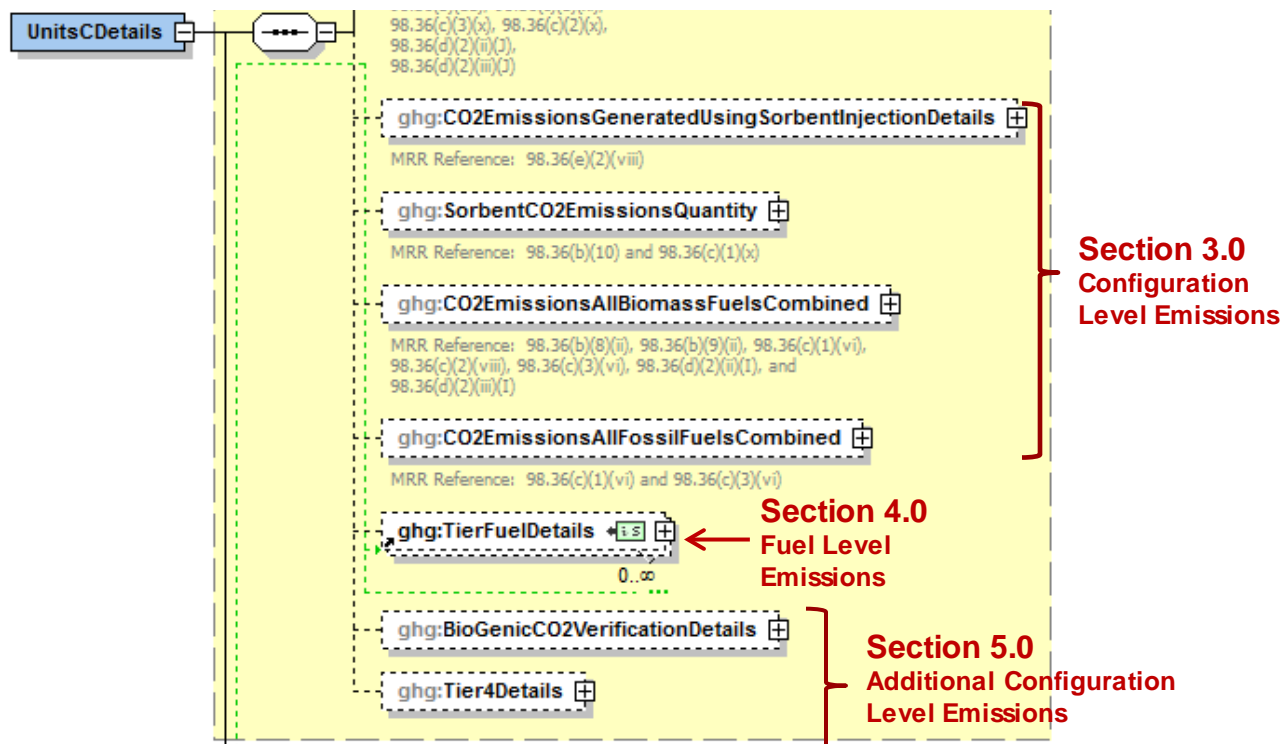



### 3.1 Configuration Type 1 Configuration Level Emissions

For configurations of **Type 1 (single unit using Tiers 1, 2 or 3)**, Subpart C requires the following emissions information aggregated at the configuration-level:

- **Conditionally Required:** If CO<sub>2</sub> emissions that are not monitored by a CEMS are generated from sorbent injection, then report the following information: [98.36(e)(2)(viii)]
  - The total amount of sorbent used during the reporting year.
  - The molecular weight of the sorbent.
  - The ratio (“R”) used in Equation C-11.
- The total annual CO<sub>2</sub> mass emissions from sorbent. [98.36(b)(10)]
- The total annual biogenic CO<sub>2</sub> mass emissions. [98.36(b)(8)(ii)]
- Biogenic CO<sub>2</sub> verification details. See [section 5.1](#) for instructions on how to report sample analysis results if ASTM methods D7459-08 and D6866-08 to determine the biogenic portion of the annual CO<sub>2</sub> emissions.

**Figure 29**  
**Configuration Type 1 Configuration Level Emissions**

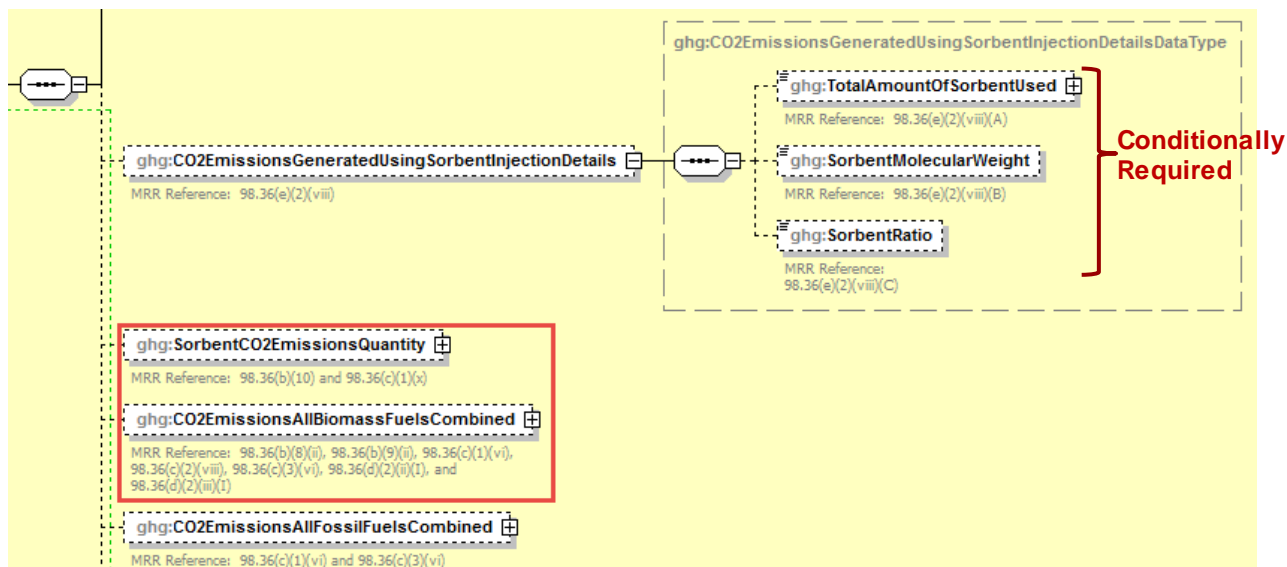

**Note:** Data elements boxed in red are required.

**Table 18**  
**Configuration Type 1 Configuration Level Emissions**  
**Data Element Definitions**

Data Element Name	Description
<b>CO2EmissionsGeneratedUsingSorbentInjectionDetails</b>	<b>Parent Element:</b> A collection of data elements containing details of the sorbent CO <sub>2</sub> emission calculation inputs.
TotalAmountOfSorbentUsed	The amount of sorbent used in acid gas control devices during the year. Report the value in the child data element <b>CalculatedValue</b> . Report zero if sorbent is not used. Set the units of measure to “Short tons” in the attribute <b>massUOM</b> . [98.36(e)(2)(viii)(A)]
SorbentMolecularWeight	The molecular weight of the sorbent. Report zero if sorbent is not used. [98.36(e)(2)(viii)(B)]
SorbentRatio	The ratio “R” in Equation C-11. “R” is the ratio of moles of CO <sub>2</sub> released from the sorbent per mole of the acid gas species removed. A default factor of 1 is used where the sorbent is CaCO <sub>3</sub> and the acid gas is SO <sub>2</sub> . Report zero if sorbent is not used. [98.36(e)(2)(viii)(C)]
<b>SorbentCO2EmissionsQuantity</b>	<b>Parent Element:</b> The calculated annual CO <sub>2</sub> emissions from sorbent. Report the value in the child data element <b>CalculatedValue</b> . Set the units of measure to “Metric Tons” in the attribute <b>massUOM</b> . [98.36(b)(10)]
<b>CO2EmissionsAllBiomassFuelsCombined</b>	<b>Parent Element:</b> Total annual biogenic CO <sub>2</sub> mass emissions for a configuration. Report the value in the child data element <b>CalculatedValue</b> . Set the units of measure to “Metric Tons” in the attribute <b>massUOM</b> . [98.36(b)(8)(ii)]

**XML Excerpt 15**  
**Example for Configuration Type 1 Configuration Level Emissions**

```
<ghg:CO2EmissionsGeneratedUsingSorbentInjectionDetails>
  <ghg:TotalAmountOfSorbentUsed massUOM="Short Tons">3500</ghg:TotalAmountOfSorbentUsed>
  <ghg:SorbentMolecularWeight>100</ghg:SorbentMolecularWeight>
  <ghg:SorbentRatio>1</ghg:SorbentRatio>
</ghg:CO2EmissionsGeneratedUsingSorbentInjectionDetails>
<ghg:SorbentCO2EmissionsQuantity massUOM="Metric Tons">
  <ghg:CalculatedValue>10.1</ghg:CalculatedValue>
</ghg:SorbentCO2EmissionsQuantity>
<ghg:CO2EmissionsAllBiomassFuelsCombined massUOM="Metric Tons">
  <ghg:CalculatedValue>100.2</ghg:CalculatedValue>
</ghg:CO2EmissionsAllBiomassFuelsCombined>
```

**Note:** The code excerpt above is presented here to demonstrate the concept of reporting greenhouse gas emissions data.

 See [Section 4.0](#) for instructions on how to report fuel data for configuration type 1 units.

### 3.2 Configuration Type 2 Configuration Level Emissions

For configurations of **Type 2 (single unit using Tier 4)**, Subpart C requires the following information aggregated at the configuration-level.

- Biogenic CO<sub>2</sub> verification details. See [section 5.1](#) for instruction on how to report sample analysis results if ASTM methods D7459-08 and D6866-08 were used to determine the biogenic portion of the annual CO<sub>2</sub> emissions.
- Tier 4 details. See [section 5.2](#) for instructions on how to report configuration-level emissions information for units using the Tier 4 methodology.

### 3.3 Configuration Type 3 Configuration Level Emissions

For configurations of **Type 3 (aggregation of units)**, Subpart C requires the following emissions information aggregated at the configuration-level:

- **Conditionally Required:** If CO<sub>2</sub> emissions that are not monitored by a CEMS are generated from sorbent injection, then report the following information: [98.36(e)(2)(viii)]
  - The total amount of sorbent used during the reporting year.
  - The molecular weight of the sorbent.
  - The ratio (“R”) used in Equation C-11.
- The total annual CO<sub>2</sub> mass emissions from sorbent. [98.36(c)(1)(x)]
- The total annual biogenic CO<sub>2</sub> mass emissions. [98.36(c)(1)(vi)]
- The total annual CO<sub>2</sub> mass emissions from the combustion of fossil fuels. [98.36(c)(1)(vi)]
- Biogenic CO<sub>2</sub> verification details. See [section 5.1](#) for instructions on how to report sample analysis results if ASTM methods D7459-08 and D6866-08 to determine the biogenic portion of the annual CO<sub>2</sub> emissions.

**Figure 30**  
**Configuration Type 3 Configuration Level Emissions Schema Diagram**

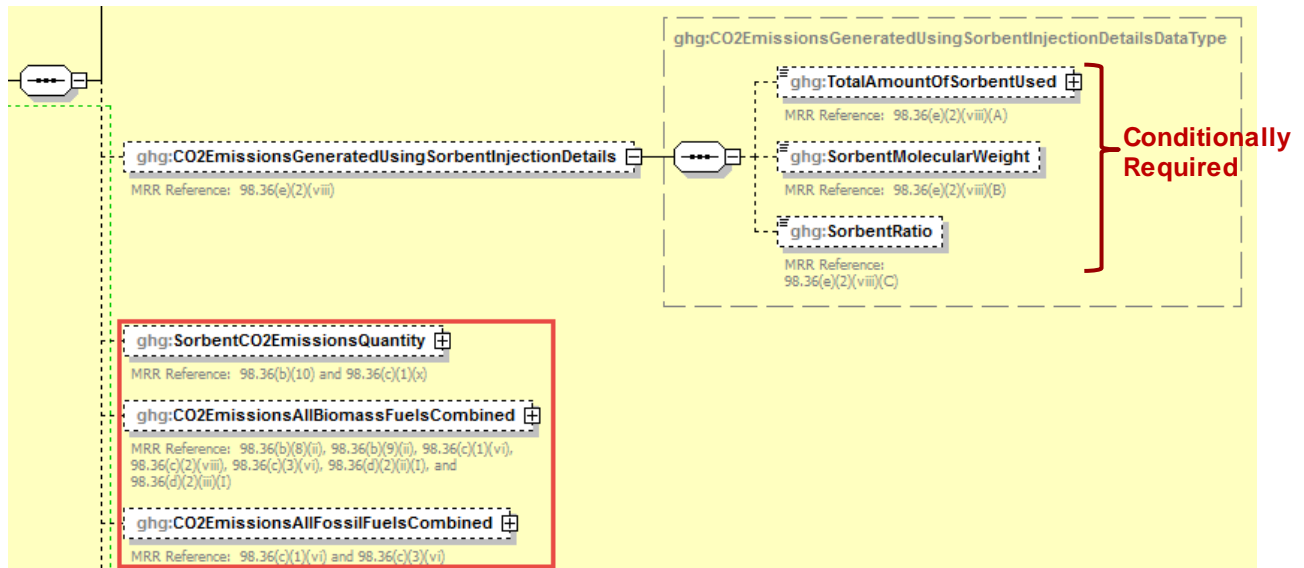

**Note:** Data elements boxed in red are required.

**Table 19**  
**Configuration Type 3 Configuration Level Emissions**  
**Data Element Definitions**

Data Element Name	Description
<b>CO2EmissionsGeneratedUsingSorbentInjectionDetails</b>	<b>Parent Element:</b> A collection of data elements containing details of the sorbent CO <sub>2</sub> emission calculation inputs.
TotalAmountOfSorbentUsed	The amount of sorbent used in acid gas control devices during the year. Report the value in the child data element <b>CalculatedValue</b> . Report zero if sorbent is not used. Set the units of measure to “Short tons” in the attribute <b>massUOM</b> . [98.36(e)(2)(viii)(A)]
SorbentMolecularWeight	The molecular weight of the sorbent. Report zero if sorbent is not used. [98.36(e)(2)(viii)(B)]
SorbentRatio	The ratio “R” in Equation C-11. “R” is the ratio of moles of CO <sub>2</sub> released from the sorbent per mole of the acid gas species removed. A default factor of 1 is used where the sorbent is CaCO <sub>3</sub> and the acid gas is SO <sub>2</sub> . Report zero if sorbent is not used. [98.36(e)(2)(viii)(C)]

Data Element Name	Description
<b>SorbentCO2EmissionsQuantity</b>	<b>Parent Element:</b> The calculated annual CO <sub>2</sub> emissions from sorbent. Report the value in the child data element <b>CalculatedValue</b> . Set the units of measure to “Metric Tons” in the attribute <b>massUOM</b> . [98.36(b)(10)]
<b>CO2EmissionsAllBiomassFuelsCombined</b>	<b>Parent Element:</b> Total annual biogenic CO <sub>2</sub> mass emissions for a configuration. Report the value in the child data element <b>CalculatedValue</b> . Set the units of measure to “Metric Tons” in the attribute <b>massUOM</b> . [98.36(b)(8)(ii)]
<b>CO2EmissionsAllFossilFuelsCombined</b>	<b>Parent Element:</b> The calculated annual CO <sub>2</sub> mass emissions from the combustion of all fossil fuels for a configuration. Report the value in the child data element <b>CalculatedValue</b> . Set the units of measure to “Metric Tons” in the attribute <b>massUOM</b> . [98.36(c)(1)(vi)]

### XML Excerpt 16 Example for Configuration Type 3 Configuration Level Emissions

```

<ghg:CO2EmissionsGeneratedUsingSorbentInjectionDetails>
  <ghg:TotalAmountOfSorbentUsed massUOM="Short Tons">3500</ghg:TotalAmountOfSorbentUsed>
  <ghg:SorbentMolecularWeight>100</ghg:SorbentMolecularWeight>
  <ghg:SorbentRatio>1</ghg:SorbentRatio>
</ghg:CO2EmissionsGeneratedUsingSorbentInjectionDetails>
<ghg:SorbentCO2EmissionsQuantity massUOM="Metric Tons">
  <ghg:CalculatedValue>50.3</ghg:CalculatedValue>
</ghg:SorbentCO2EmissionsQuantity>
<ghg:CO2EmissionsAllBiomassFuelsCombined massUOM="Metric Tons">
  <ghg:CalculatedValue>500.6</ghg:CalculatedValue>
</ghg:CO2EmissionsAllBiomassFuelsCombined>
<ghg:CO2EmissionsAllFossilFuelsCombined massUOM="Metric Tons">
  <ghg:CalculatedValue>50000.8</ghg:CalculatedValue>
</ghg:CO2EmissionsAllFossilFuelsCombined>

```

**Note:** The code excerpt above is presented here to demonstrate the concept of reporting greenhouse gas emissions data.

 See [Section 4.0](#) for instructions on how to report fuel data for the configuration identified.

### 3.4 Configuration Type 4 Configuration Level Emissions

For configurations of **Type 4 (non-CEMS group of units sharing common fuel supply pipe)**, Subpart C requires the following emissions information aggregated at the configuration-level:

- The total annual biogenic CO<sub>2</sub> mass emissions. [98.36(c)(3)(vi)]
- The total annual CO<sub>2</sub> mass emissions from the combustion of fossil fuels. [98.36(c)(3)(vi)]
- Biogenic CO<sub>2</sub> verification details. See [section 5.1](#) for instructions on how to report sample analysis results if ASTM methods D7459-08 and D6866-08 to determine the biogenic portion of the annual CO<sub>2</sub> emissions.

**Figure 31**  
**Configuration Type 4 Configuration Level Emissions Schema Diagram**

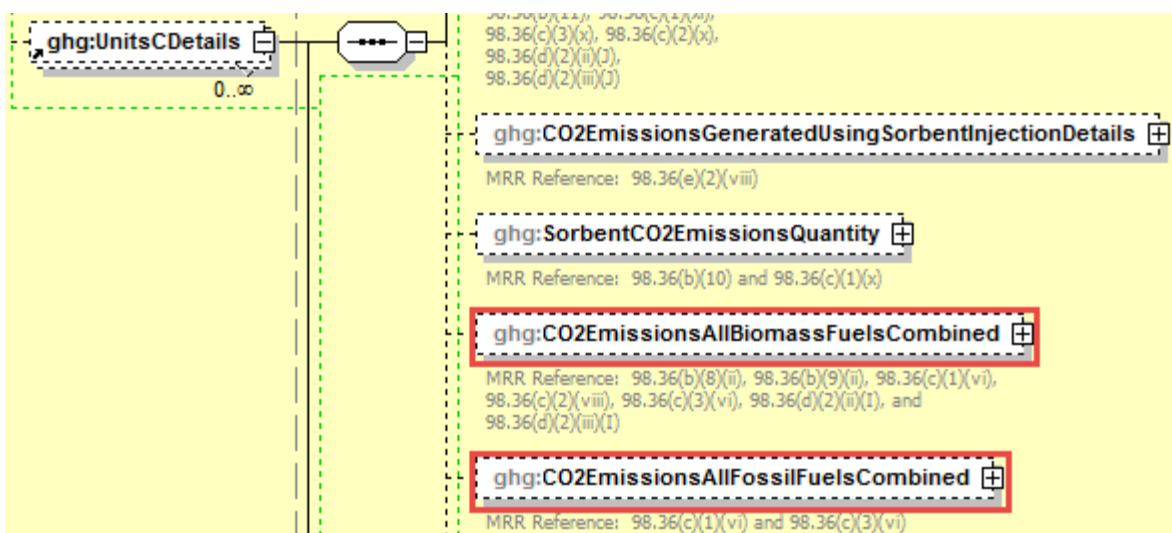

Note: Data elements boxed in red are required.

**Table 20**  
**Configuration Type 4 Configuration Level Emissions Data Element Definitions**

Data Element Name	Description
<b>CO2EmissionsAllBiomassFuelsCombined</b>	<b>Parent Element:</b> Total annual biogenic CO <sub>2</sub> mass emissions for a configuration. Report the value in the child data element <b>CalculatedValue</b> . Set the units of measure to “Metric Tons” in the attribute <b>massUOM</b> .
<b>CO2EmissionsAllFossilFuelsCombined</b>	<b>Parent Element:</b> The calculated annual CO <sub>2</sub> mass emissions from the combustion of all fossil fuels for a configuration. Report the value in the child data element <b>CalculatedValue</b> . Set the units of measure to “Metric Tons” in the attribute <b>massUOM</b> .

### XML Excerpt 17 Example for Configuration Type 4 Configuration Level Emissions

```
<ghg:CO2EmissionsAllBiomassFuelsCombined massUOM="Metric Tons">  
  <ghg:CalculatedValue>600.8</ghg:CalculatedValue>  
</ghg:CO2EmissionsAllBiomassFuelsCombined>  
<ghg:CO2EmissionsAllFossilFuelsCombined massUOM="Metric Tons">  
  <ghg:CalculatedValue>60000.9</ghg:CalculatedValue>  
</ghg:CO2EmissionsAllFossilFuelsCombined>
```

**Note:** The code excerpt above is presented here to demonstrate the concept of reporting greenhouse gas emissions data.

 See [Section 4.0](#) for instructions on how to report fuel data for the configuration identified.

### 3.5 Configuration Type 5 Configuration Level Emissions

For configurations of **Type 5 (units with a common stack or duct using Tier 4)**, Subpart C requires additional information aggregated at the configuration-level.

- Biogenic CO<sub>2</sub> verification details. See [section 5.1](#) for instructions on how to report sample analysis results if ASTM methods D7459-08 and D6866-08 were used to determine the biogenic portion of the annual CO<sub>2</sub> emissions.
- Tier 4 details. See [section 5.2](#) for instructions on how to report configuration-level emissions information for units using the Tier 4 methodology.



### 3.6 Configuration Type 6 Configuration Level Emissions

For configurations of **Type 6 (year-round Part 75 heat input reporters)**, Subpart C requires the following additional information aggregated at the configuration-level:

- The total annual biogenic CO<sub>2</sub> mass emissions. [98.36(d)(2)(ii)(I), 98.36(d)(2)(iii)(I)]
- Additional configuration-level emissions information for units using the Part 75 methodology.

**Figure 32**  
**Configuration Type 6 Configuration Level Emissions Schema Diagram**

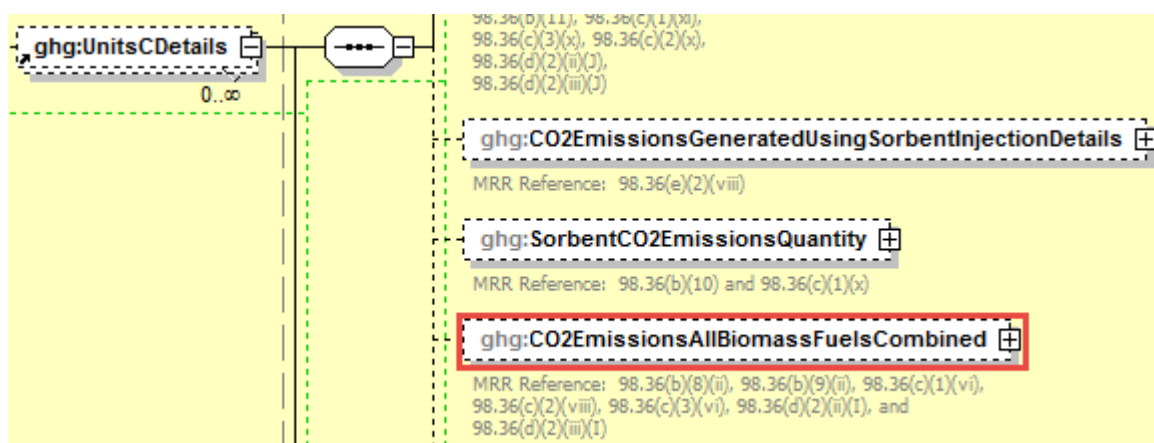

**Note:** Data elements boxed in red are required.

**Table 21**  
**Configuration Type 6 Configuration Level Emissions Data Element Definitions**

Data Element Name	Description
<b>CO2EmissionsAllBiomassFuelsCombined</b>	<b>Parent Element:</b> Total annual biogenic CO <sub>2</sub> mass emissions for a configuration. Report the value in the child data element <b>CalculatedValue</b> . Set the units of measure to “Metric Tons” in the attribute <b>massUOM</b> .

**XML Excerpt 18**  
**Example for Configuration Type 6 Configuration Level Emissions**

```
<ghg:CO2EmissionsAllBiomassFuelsCombined massUOM="Metric Tons">
  <ghg:CalculatedValue>1000.5</ghg:CalculatedValue>
</ghg:CO2EmissionsAllBiomassFuelsCombined>
```

**Note:** The code excerpt above is presented here to demonstrate the concept of reporting greenhouse gas emissions data.

**Figure 33**  
**Part 75 Details Schema Diagram**

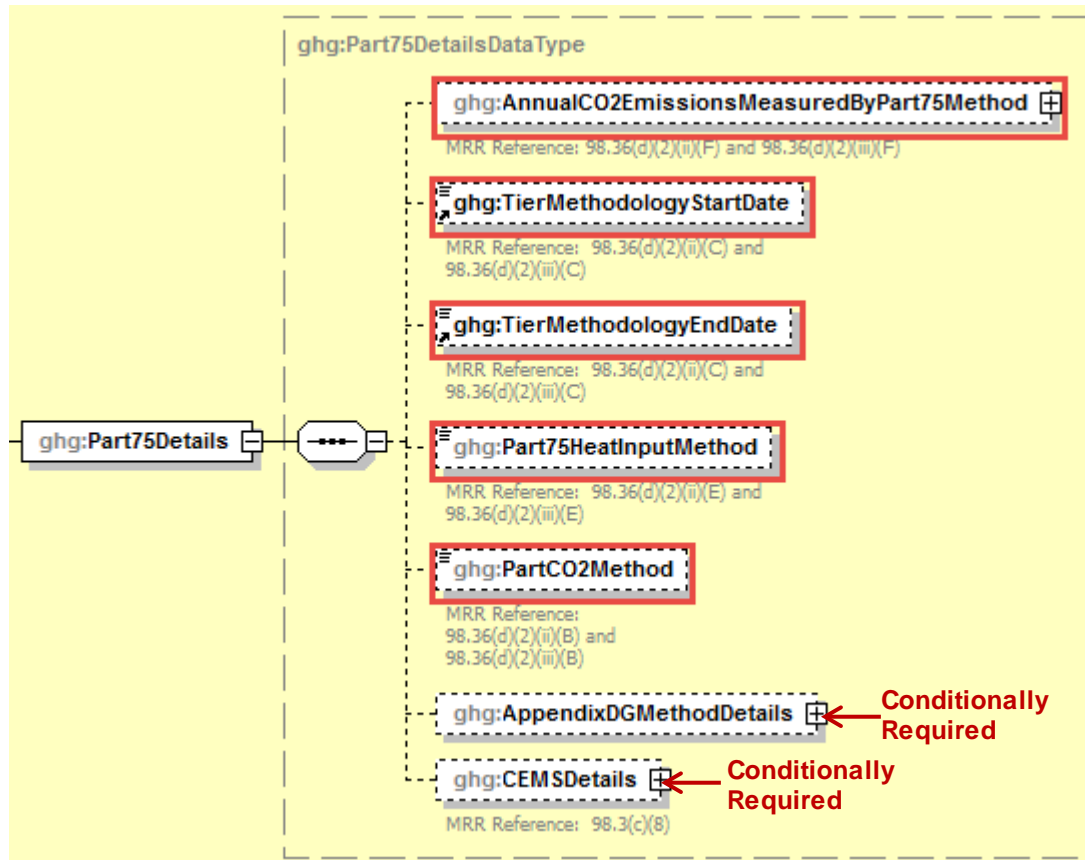

**Note:** Data elements boxed in red are required. Please see page 4 of this document for more information on conditionally required elements.

For configurations of **Type 6 (year-round Part 75 heat input reporters)**, Subpart C requires the following additional information aggregated at the configuration-level:

- The total annual CO<sub>2</sub> mass emissions at the monitored location [98.36(d)(2)(ii)(F), 98.36(d)(2)(iii)(F)]
- The methodology start date and end date [98.36(d)(ii)(C)-(D), 98.36(d)(iii)(C)-(D)]
- An indication of the Part 75 heat input method used (Appendix D method, Low Mass Emissions calculation method in 40 CFR 75.19 or CEMS calculation method) [98.36(d)(2)(ii)(E), 98.36(d)(2)(iii)(E)]
- The Part 75 methodology used to calculate the CO<sub>2</sub> mass emissions (Appendix D and G calculation method, Low Mass Emissions calculation method in 40 CFR 75.19 or CEMS calculation method) [98.36(d)(2)(ii)(B), 98.36(d)(2)(iii)(B)].

**Table 22**  
**Part 75 Details Data Element Definitions**

Data Element Name	Description
<b>Part75Details</b>	<b>Parent Element (Conditionally Required):</b> A collection of data elements containing information for certain Part 75 units that use the alternative calculation methods in 98.33(a)(5).
AnnualCO2EmissionsMeasuredByPart75Method	The total annual CO <sub>2</sub> emissions measured at the monitored location using the applicable Part 75 methodology (include both biogenic and non-biogenic CO <sub>2</sub> ). Report the value in the child data element <b>CalculatedValue</b> . Set the units of measure to “Metric Tons” in the attribute <b>massUOM</b> .
TierMethodologyStartDate	The methodology start date for the specified reporting configuration (YYYY-MM-DD).
TierMethodologyEndDate	The methodology end date for the specified reporting configuration (YYYY-MM-DD).
Part75HeatInputMethod	The method used to measure the Part 75 heat input. See list of allowable values:  Appendix D LME---40CFR 75.19 CEMS
PartCO2Method	The Part 75 method used to calculate the CO <sub>2</sub> emissions. See list of allowable values:  Appendix D and G calculation method--- § 98.33(a)(5)(i) LME calculation method in 40 CFR 75.19--- § 98.33(a)(5)(ii) CEMS calculation method--- § 98.33(a)(5)(iii)

**XML Excerpt 19**  
**Example for Part 75 Details**

```

<ghg:Part75Details>
  <ghg:AnnualCO2EmissionsMeasuredByPart75Method massUOM="Metric Tons">
    <ghg:CalculatedValue>80000.6 </ghg:CalculatedValue>
  </ghg:AnnualCO2EmissionsMeasuredByPart75Method>
  <ghg:TierMethodologyStartDate>2011-01-01 </ghg:TierMethodologyStartDate>
  <ghg:TierMethodologyEndDate>2011-12-31 </ghg:TierMethodologyEndDate>
  <ghg:Part75HeatInputMethod>Appendix D </ghg:Part75HeatInputMethod>
  <ghg:PartCO2Method>Appendix D and G calculation method--- § 98.33(a)(5)(i) </ghg:PartCO2Method>

```

**Note:** The code excerpt above is presented here to demonstrate the concept of reporting greenhouse gas emissions data.

**Figure 34**  
**Appendix D and G Calculation Method Details Schema Diagram**

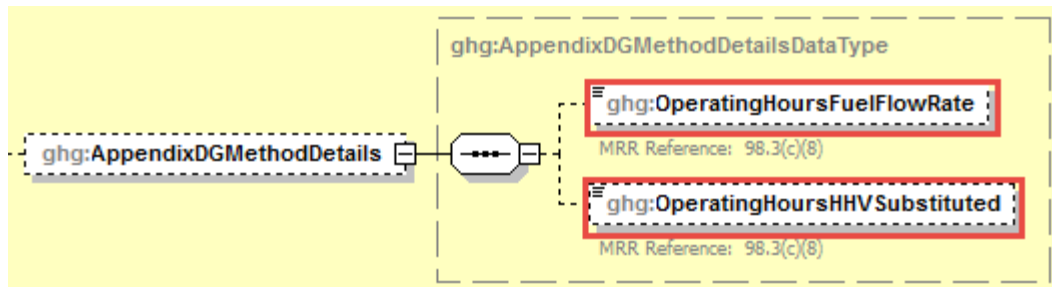

**Note:** Data elements boxed in red are required.



*Is the Appendix D and G calculation method the Part 75 methodology used to calculate CO<sub>2</sub> emissions?*

If the Part 75 methodology used to calculate the CO<sub>2</sub> mass emissions is Appendix D and G calculation method, then the following information is required:

- Total number of operating hours during the year that fuel flow rate data was missing [98.3(c)(8)]
- Total number of operating hours during the year that high heating value data was missing [98.3(c)(8)]

**Table 23**  
**Appendix D and G Calculation Method Details Data Element Definitions**

Data Element Name	Description
AppendixDGMethodDetails	<b>Parent Element (Conditionally Required):</b> A collection of data elements to report for each unit or stack for which the facility selects "Appendix D & G Calculation Method" as the Part 75 methodology used to determine CO <sub>2</sub> mass emissions
OperatingHoursFuelFlowRate	Total number of operating hours during the year that fuel flow rate data was missing.
OperatingHoursHHVSubstituted	Total number of operating hours during the year that high heating value data was missing.

## XML Excerpt 20

### Example for Appendix D and G Calculation Method Details

```

<ghg:AppendixDGMethoDetails>
  <ghg:OperatingHoursFuelFlowRate>80</ghg:OperatingHoursFuelFlowRate>
  <ghg:OperatingHoursHHVSubstituted>8</ghg:OperatingHoursHHVSubstituted>
</ghg:AppendixDGMethoDetails>
</ghg:Part75Details>

```

**Note:** The code excerpt above is presented here to demonstrate the concept of reporting greenhouse gas emissions data.

**Figure 35**  
**CEMS Details Schema Diagram**

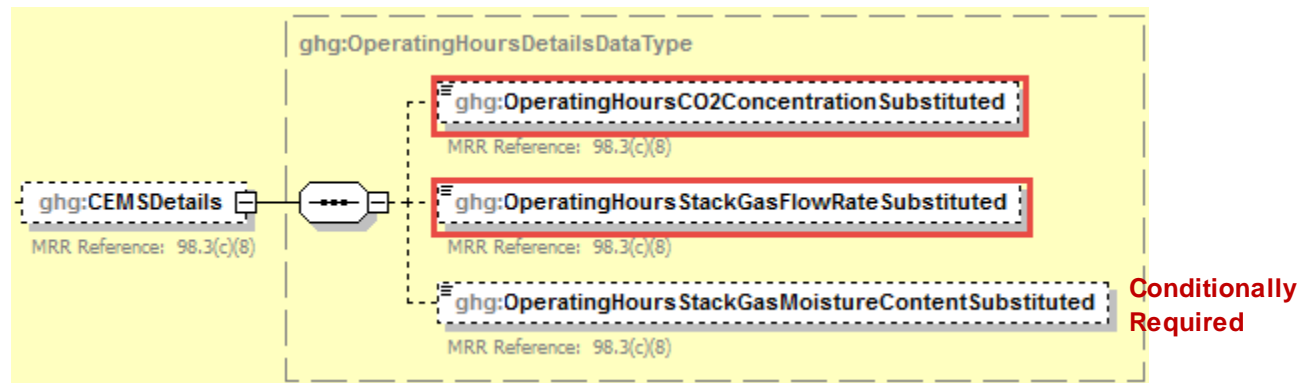

**Note:** Data elements boxed in red are required. Please see page 4 of this document for more information on conditionally required elements.



*Is the CEMS calculation method the Part 75 methodology used to calculate CO<sub>2</sub> emissions?*

If the Part 75 methodology used to calculate the CO<sub>2</sub> mass emissions is CEMS calculation method, then for configurations of **Type 6 (year-round Part 75 heat input reporters)**, Subpart C requires the following additional information aggregated at the configuration-level:

- The total number of source operating hours in the reporting year that the CO<sub>2</sub> concentration parameter was missing (if an O<sub>2</sub> monitor is used to calculate CO<sub>2</sub> concentration, report missing data for the O<sub>2</sub> monitor here) [98.36(e)(2)(vi)(C), 98.3(c)(8)]
- The total number of source operating hours in the reporting year that the stack gas flow rate parameter was missing [98.36(e)(2)(vi)(C), 98.3(c)(8)]
- The total number of source operating hours in the reporting year that the moisture content parameter was missing (if a continuous monitor is in use) [98.36(e)(2)(vi)(C), 98.3(c)(8)]



**Table 24**  
**CEMS Details Data Element Definitions**

Data Element Name	Description
<b>CEMSDetails</b>	<b>Parent Element (Conditionally Required):</b> A collection of data elements pertaining to the number of hours missing data procedures were for each unit or stack in which the facility selects "CEMS" as the Part 75 methodology used to determine CO <sub>2</sub> mass emissions
OperatingHoursCO2ConcentrationSubstituted	The total operating hours in which a substitute data value was used in the emissions calculations for the CO <sub>2</sub> concentration parameter.
OperatingHoursStackGasFlowRateSubstituted	The total operating hours in which a substitute data value was used in the emissions calculations for the stack gas flow rate parameter.
OperatingHoursStackGasMoistureContentSubstituted	<b>Conditionally Required:</b> If moisture correction is required and a continuous moisture monitor is used, the total operating hours in which a substitute data value was used in the emissions calculations for the stack gas moisture content parameter. Otherwise, do not report this element.

**XML Excerpt 21**  
**Example for CEMS Details**

```
<ghg:CEMSDetails>
  <ghg:OperatingHoursCO2ConcentrationSubstituted>1000</ghg:OperatingHoursCO2ConcentrationSubstituted>
  <ghg:OperatingHoursStackGasFlowRateSubstituted>10</ghg:OperatingHoursStackGasFlowRateSubstituted>
  <ghg:OperatingHoursStackGasMoistureContentSubstituted>1</ghg:OperatingHoursStackGasMoistureContentSubstituted>
</ghg:CEMSDetails>
</ghg:Part75Details>
```

**Note:** The code excerpt above is presented here to demonstrate the concept of reporting greenhouse gas emissions data.

-  See [Section 2.0](#) for instructions on how to report for a different configuration.
-  See [Section 4.0](#) for instructions on how to report fuel data for the configuration identified.
-  See [Section 6.0](#) for instructions on how to report facility level roll-up emissions.

### 4.0 Fuel Level Emissions by Configuration Type

For configurations of all types, Subpart C requires you to identify the following for **each configuration**:

- The fuel types combusted during the reporting year [98.36(b)(4), 98.36(c)(1)(v), 98.36(c)(2)(iv), 98.36(c)(3)(iv), 98.36(d)(2)(ii)(A) and 98.36(d)(2)(iii)(A)]

Separately report each fuel combusted in the configuration during the report year along with the associated emissions information. The required information for each fuel will depend on which tier was used to calculate CO<sub>2</sub> emissions.

**Figure 36**  
**Tier Fuel Details Schema Diagram**

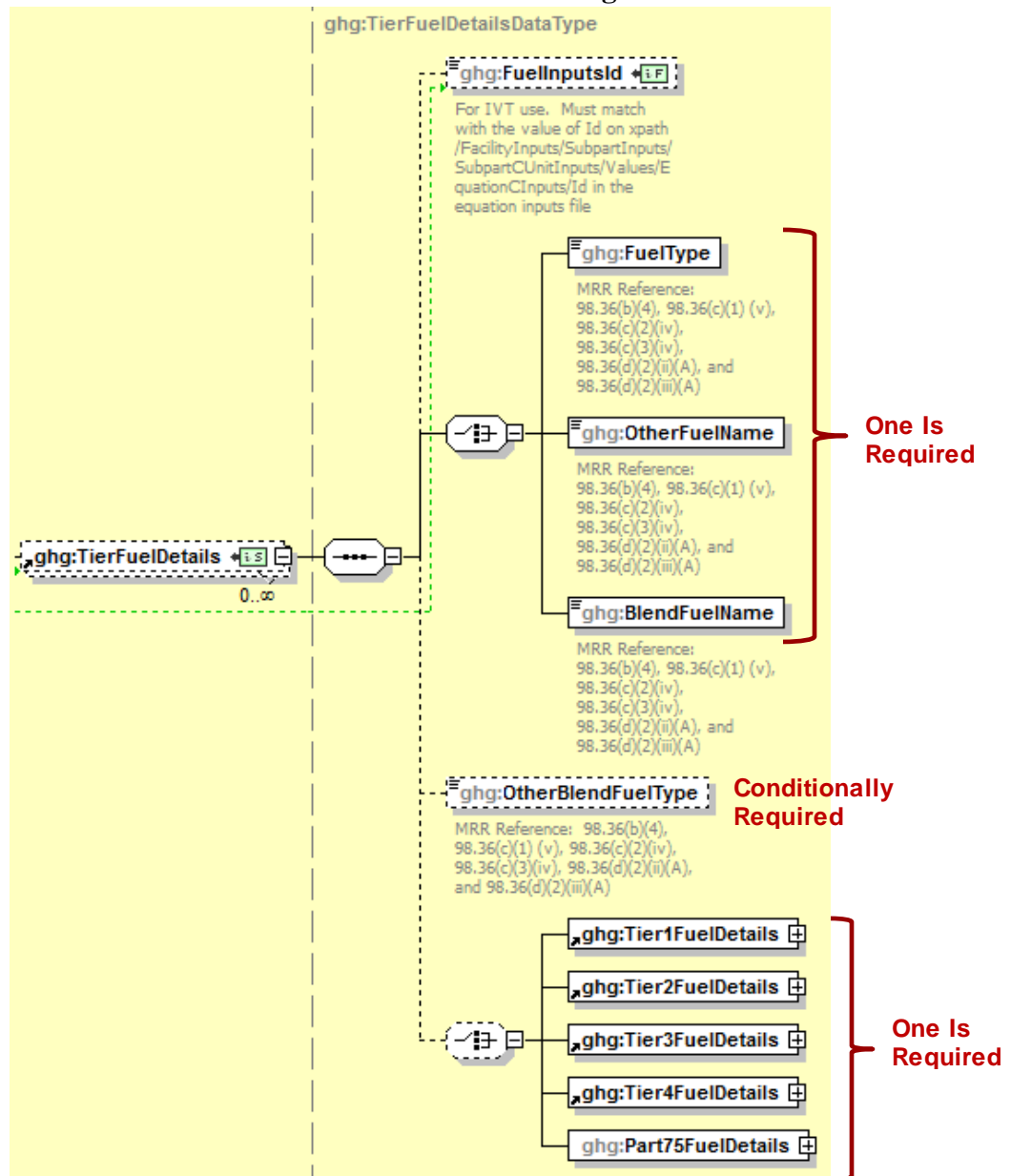

**Note:** Please see page 4 of this document for more information on conditionally required elements.

Report the fuel type. (See list of allowable fuel types.) If the fuel type does not appear in the list and the use of Tier 3 is required, then specify its name using the "OtherFuelName" element. If a blend of fuels was combusted and the fuels cannot be reported individually, report the blend name using "BlendFuelName".

The user should refer to 98.33(b) to determine which Tier is required for each fuel type at the configuration.

Note that Tiers 1-3 could only apply to Configurations of **Type 1 (single unit using Tiers 1, 2 or 3), Type 3 (aggregation of units) and Type 4 (common pipe)**. For each fuel in a configuration, the user will specify which tier is used and which equation was used for that fuel.

For Configurations of **Type 2 (single unit Using Tier 4) or Type 5 (common stack or duct)**, the user will report the applicable information for each fuel under the Tier4FuelDetails node.

For Configurations of **Type 6 (Part 75 heat input reporters)**, the user will report the applicable information for each fuel under the Part75FuelDetails node.

**Table 25  
Tier Fuel Details Data Element Definitions**

Data Element Name	Description
<b>TierFuelDetails</b>	<b>Parent Element:</b> A collection of data elements containing information regarding the types of fuels combusted in the reporting configuration and broken out by CO <sub>2</sub> calculation methodology.
FuelInputsID	<p><b>Conditionally Required:</b> If using the Inputs Verifier Tool for uploading inputs, enter the value of the ID on the xpath for the IVT inputs file:</p> <p><i>FacilityInputs/SubpartInputs/SubpartCUnitInputs/Values/EquationCInputs/Id</i></p> <p><b>Important:</b> The ID reported in the FuelInputsID data element must match the Id in the IVT file at the xpath shown above EXACTLY.</p>
FuelType	<p><b>Conditionally Required:</b> If the fuel type is on the list of allowable values, then specify the type of fuel combusted in the reporting configuration during the report year. See list of allowable fuel types below. If reporting a fuel not on the list or a blended fuel, then specify its name using one of the following data elements, "OtherFuelName" or "BlendFuelName" as appropriate, and do not report this data element.</p> <ul style="list-style-type: none"> <li>Anthracite</li> <li>Bituminous</li> <li>Subbituminous</li> <li>Lignite</li> <li>Coke (RY10-12 only)</li> <li>Coal Coke</li> <li>Mixed (Commercial sector)</li> <li>Mixed (Industrial coking)</li> <li>Mixed (Industrial sector)</li> <li>Mixed (Electric Power sector)</li> <li>Mixed (Electric Power sector)</li> <li>Plastics</li> <li>Petroleum Coke</li> <li>Municipal Solid Waste</li> </ul>



	<p> Tires  Wood and Wood Residuals (RY10-12 only)  Wood and Wood Residuals (dry basis)  Agricultural Byproducts  Peat  Distillate Fuel Oil No. 1  Distillate Fuel Oil No. 2  Distillate Fuel Oil No. 4  Residual Fuel Oil No. 5  Residual Fuel Oil No. 6  Used Oil  Kerosene  Liquefied petroleum gases (LPG)  Propylene  Ethane  Ethanol (100%)  Ethylene  Isobutane  Isobutylene  Butane  Butylene  Naphtha (&lt;401 deg F)  Natural Gasoline  Other Oil (&gt;401 deg F)  Pentanes Plus  Petrochemical Feedstocks  Petroleum Coke  Special Naphtha  Unfinished Oils  Heavy Gas Oils  Lubricants  Motor Gasoline  Aviation Gasoline  Kerosene-Type Jet Fuel  Asphalt and Road Oil  Crude Oil  Propane  Ethanol  Biodiesel (100%)Biodiesel  Rendered Animal Fat  Vegetable Oil  Natural Gas (Weighted U.S. Average)  Blast Furnace Gas  Coke Oven Gas  Propane Gas  Fuel Gas  Biogas (Captured methane) (RY10-12 only)  Landfill Gas  Solid Byproducts  Other Biomass Gases </p>
OtherFuelName	<b>Conditionally Required:</b> Name of the specific fuel if not found in the list of allowable values and the use of Tier 3 is required. Otherwise, do not report this element.
BlendFuelName	<b>Conditionally Required:</b> Name of the specific fuel blend if the blended fuels cannot be reported individually. Otherwise, do not report this element.

OtherBlendFuelType	<p><b>Conditionally Required:</b> If OtherFuelName or BlendFuelName is reported, the type of other fuel or blend fuel must be specified. Otherwise, do not report this element.</p> <p>Other (gas)  Other (liquid)  Other (solid)  Blend (gas)  Blend (liquid)  Blend (solid)</p>
--------------------	---

### XML Excerpt 22 Example for Tier Fuel Details

```

<ghg:TierFuelDetails>
  <ghg:OtherFuelName>Recovered liquid</ghg:OtherFuelName>
  <ghg:OtherBlendFuelType>Other (liquid)</ghg:OtherBlendFuelType>
</ghg:TierFuelDetails>
```

**Note:** The code excerpt above is presented here to demonstrate the concept of reporting greenhouse gas emissions data.



*Which calculation methodology will you use to calculate fuel emissions?*

The calculation methodologies are as follows:

- ↳ [Tier 1](#) – includes Equation C-1, Equation C-1a and Equation C-1b [98.33(a)(1)]
- ↳ [Tier 2](#) – includes Equation C-2a and Equation C-2c [98.33(a)(2)]
- ↳ [Tier 3](#) – includes Equation C-3, Equation C-4 and Equation C-5 [98.33(a)(3)]
- ↳ [Tier 4](#) – by using quality-assured data from CEMS [98.33(a)(4)]
- ↳ [Part 75 alternative methods](#) – for certain units subject to Part 75 [98.33(a)(5)]

### 4.1 Tier 1 Fuel Details

**Figure 37**  
**Tier 1 Fuel Details Schema Diagram**

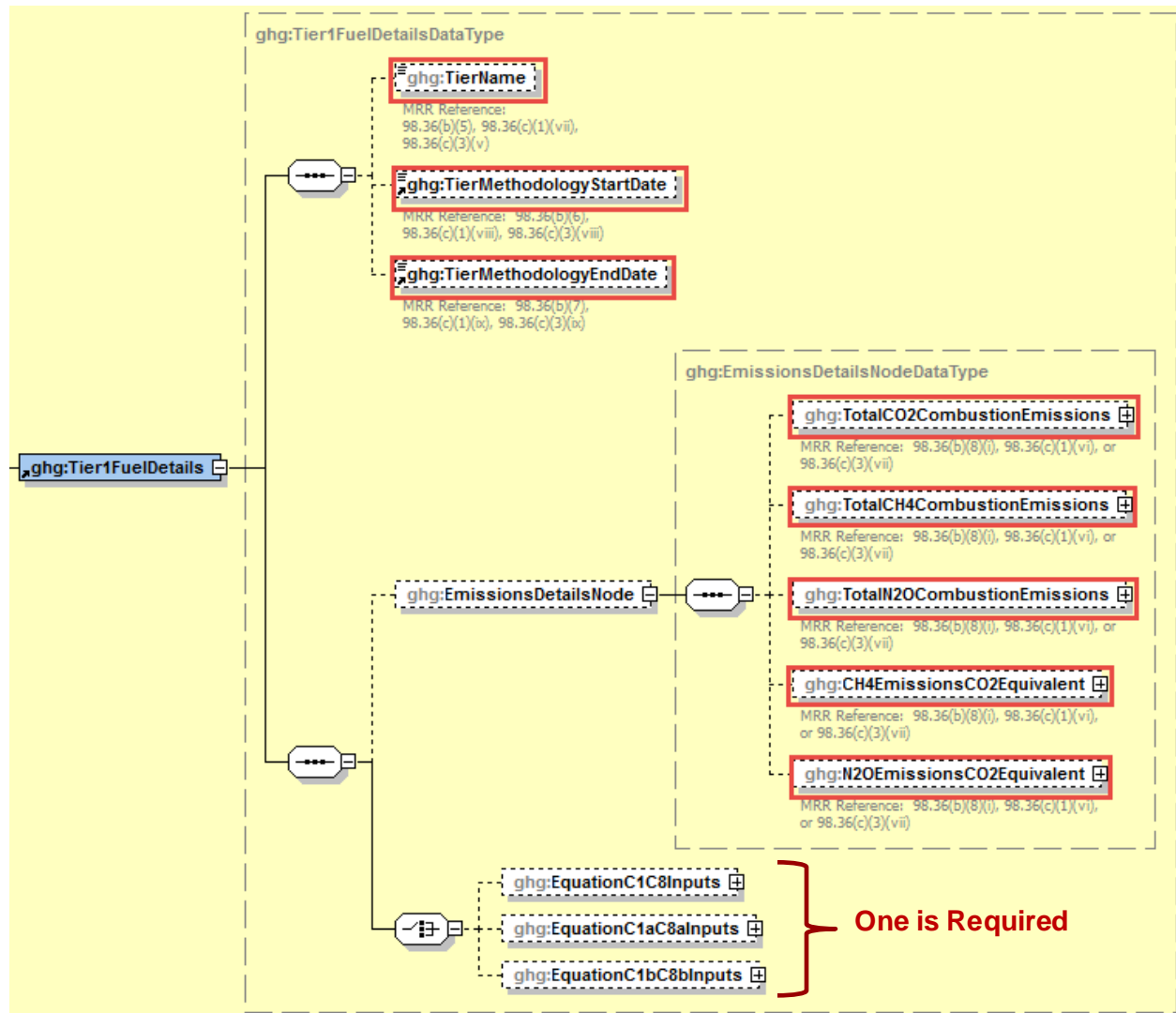

Note: Data elements boxed in red are required.

For each fuel type (including biomass fuel(s)) in a configuration that uses **Tier 1**, you will be required to specify which Tier 1 equation is used to calculate CO<sub>2</sub> emissions.

The following information is required for each fuel type combusted in the unit:

- Calculation methodology used for the emissions calculation period specified, for each fuel type [98.36(b)(5), 98.36(c)(1)(vii), 98.36(c)(3)(v)]:

- Tier 1/Equation C-1 - Annual fuel combusted, default heating value and default CO<sub>2</sub> emission factor
- Tier 1/Equation C-1a - Annual natural gas usage from billing records (therms) and default CO<sub>2</sub> emission factor
- Tier 1/Equation C-1b - Annual natural gas usage from billing records (mmBtu) and default CO<sub>2</sub> emission factor
- Calculation methodology start date and end date for each fuel type [98.36(b)(6)-(7), 98.36(c)(1)(viii)-(ix), 98.36(c)(3)(viii)-(ix)]

**Table 26**  
**Tier 1 Fuel Details Data Element Definitions**

Data Element Name	Description
<b>Tier1FuelDetails</b>	<b>Parent Element (Conditionally Required):</b> Collection of data elements containing details about Tier 1 fuel usage
TierName	The name of the Tier 1 methodology used to calculate emissions for the specified reporting configuration and specified fuel. For example, “Tier 1 (Equation C-1)”. See list of allowable values:  Tier 1 (Equation C-1) Tier 1 (Equation C-1a, natural gas billing in therms) Tier 1 (Equation C-1b, natural gas billing in mmBtu)
TierMethodologyStartDate	The methodology start date for the specified fuel type (YYYY-MM-DD).
TierMethodologyEndDate	The methodology end date for the specified fuel type (YYYY-MM-DD).
<b>EmissionsDetailsNode</b>	<b>Parent Element:</b> A collection of data elements containing inputs for equations related to Tier 1 fuel usage.
<b>EquationC1 C8Details</b>	<b>Parent Element: (Conditionally Required)</b> A collection of data elements containing inputs for Equation C-1 and C-8.
<b>EquationC1 aC8 aDetails</b>	<b>Parent Element: (Conditionally Required)</b> A collection of data elements containing inputs for Equation C-1a and C-8a.
<b>EquationC1 bC8 bDetails</b>	<b>Parent Element: (Conditionally Required)</b> A collection of data elements containing inputs for Equation C-1b and C-8b.

**XML Excerpt 23**  
**Example for Tier 1 Fuel Details**

```

<ghg:Tier1FuelDetails >
  <ghg:TierName >Tier 1 (Equation C-1b, natural gas billing in mmBtu)</ghg:TierName >
    <ghg:TierMethodologyStartDate >2011-01-01</ghg:TierMethodologyStartDate >
    <ghg:TierMethodologyEndDate >2011-12-31</ghg:TierMethodologyEndDate >

```

**Note:** The code excerpt above is presented here to demonstrate the concept of reporting greenhouse gas emissions data.

Once the fuel type and CO<sub>2</sub> calculation method are specified, fuel specific emission information must be reported.

For each fuel type (including biomass fuel(s)) for which you have elected to use a **Tier 1 (Equation C-1, C-1a or C-1b)** methodology, Subpart C requires you to report the following information by fuel type:

- The total annual CO<sub>2</sub> mass emissions derived from Equation C-1, Equation C-1a or Equation C-1b, in metric tons CO<sub>2</sub> (this value will include both non-biogenic and biogenic CO<sub>2</sub> as applicable) [98.36(b)(8)(i), 98.36(c)(1)(vi), 98.36(c)(3)(vii)]
- The total annual CH<sub>4</sub> mass emissions derived from Equation C-8, Equation C-8a or Equation C-8b in metric tons CH<sub>4</sub> and in metric tons CO<sub>2</sub>e (for Table C-2 fuels only) [98.36(b)(8)(i), 98.36(c)(1)(vi), 98.36(c)(3)(vii)]
- The total annual N<sub>2</sub>O mass emissions derived from Equation C-8, Equation C-8a or Equation C-8b in metric tons N<sub>2</sub>O and in metric tons CO<sub>2</sub>e (for Table C-2 fuels only) [98.36(b)(8)(i), 98.36(c)(1)(vi), 98.36(c)(3)(vii)]

**Table 27**  
**Tier 1 Emissions Details Node Data Element Definitions**

Data Element Name	Description
<b>EmissionsDetailsNode</b>	<b>Parent Element:</b> A collection of data elements containing inputs for equations related to Tier 1 fuel usage.
TotalCO2CombustionEmissions	The total annual CO <sub>2</sub> mass emissions (including biogenic and non-biogenic CO <sub>2</sub> ) for the specified fuel combusted in the reporting configuration, calculated using Equation C-1, C-1a or C-1b. Report the value in the child data element <b>CalculatedValue</b> . Set the units of measure to “Metric Tons” in the attribute <b>massUOM</b> .
TotalCH4CombustionEmissions	The total annual CH <sub>4</sub> mass emissions for the specified fuel combusted in the reporting configuration, calculated using Equation C-8, C-8a or C-8b. Report the value in the child data element <b>CalculatedValue</b> . Set the units of measure to “Metric Tons” in the attribute <b>massUOM</b> .
TotalN2OCombustionEmissions	The annual N <sub>2</sub> O mass emissions for the specified fuel combusted in the reporting configuration, calculated using Equation C-8, C-8a or C-8b. Report the value in the child data element <b>CalculatedValue</b> . Set the units of measure to “Metric Tons” in the attribute <b>massUOM</b> .

Data Element Name	Description
CH4EmissionsCO2Equivalent	The annual CH <sub>4</sub> mass emissions for the specified fuel combusted in the reporting configuration, expressed in CO <sub>2</sub> e. Multiply the calculated value for CH <sub>4</sub> emissions by the Global Warming Potential of 25 for reporting year 2013 and onward or 21 for reporting years 2010-2012 to arrive at the CO <sub>2</sub> e of the CH <sub>4</sub> emissions. Report the value in the child data element <b>CalculatedValue</b> . Set the units of measure to “Metric Tons” in the attribute <b>massUOM</b> .
N2OEmissionsCO2Equivalent	The annual N <sub>2</sub> O mass emissions for the specified fuel combusted in the reporting configuration, expressed in CO <sub>2</sub> e. Multiply the calculated value for N <sub>2</sub> O emissions by the Global Warming Potential of 298 for reporting year 2013 and onward or 310 for reporting years 2010-2012 to arrive at the CO <sub>2</sub> e of the N <sub>2</sub> O emissions. Report the value in the child data element <b>CalculatedValue</b> . Set the units of measure to “Metric Tons” in the attribute <b>massUOM</b> .

### XML Excerpt 24 Example for Tier 1 Emissions Details Node

```

<ghg:EmissionsDetailsNode >
  <ghg:TotalCO2CombustionEmissions massUOM="Metric Tons">
    <ghg:CalculatedValue>1300.3</ghg:CalculatedValue>
  </ghg:TotalCO2CombustionEmissions >
  <ghg:TotalCH4CombustionEmissions massUOM="Metric Tons">
    <ghg:CalculatedValue>130.78</ghg:CalculatedValue>
  </ghg:TotalCH4CombustionEmissions >
  <ghg:TotalN2OCombustionEmissions massUOM="Metric Tons">
    <ghg:CalculatedValue>13.598</ghg:CalculatedValue>
  </ghg:TotalN2OCombustionEmissions >
  <ghg:CH4EmissionsCO2Equivalent massUOM="Metric Tons">
    <ghg:CalculatedValue>2730.5</ghg:CalculatedValue>
  </ghg:CH4EmissionsCO2Equivalent >
  <ghg:N2OEmissionsCO2Equivalent massUOM="Metric Tons">
    <ghg:CalculatedValue>4030.2</ghg:CalculatedValue>
  </ghg:N2OEmissionsCO2Equivalent >
</ghg:EmissionsDetailsNode >

```

**Note:** The code excerpt above is presented here to demonstrate the concept of reporting greenhouse gas emissions data.

Once the fuel specific emission information are specified, equation-specific information must be reported.

**Figure 38**  
**Tier 1 Fuel Details Equation C1C8 Inputs Schema Diagram**

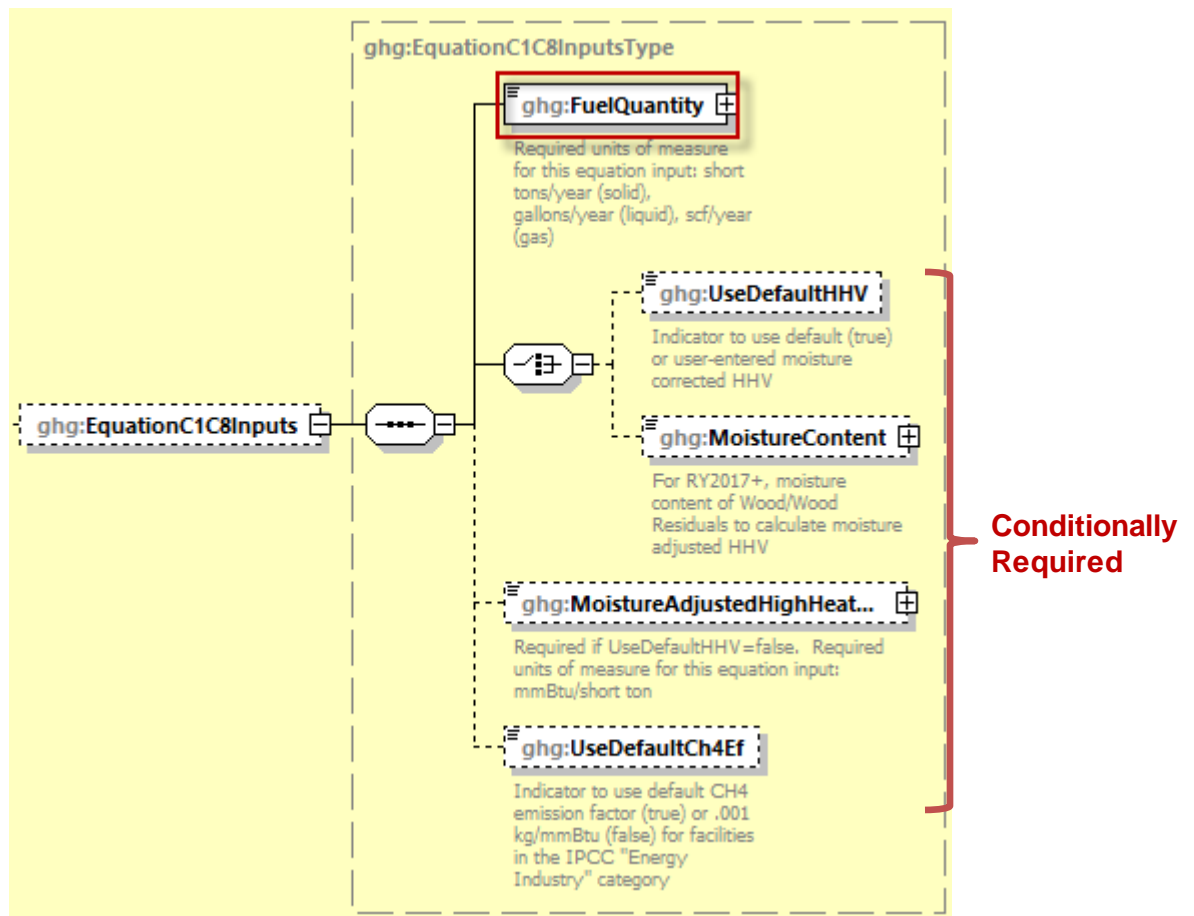

**Figure 39**  
**Tier 1 Fuel Details Equation C1aC8a Inputs Schema Diagram**

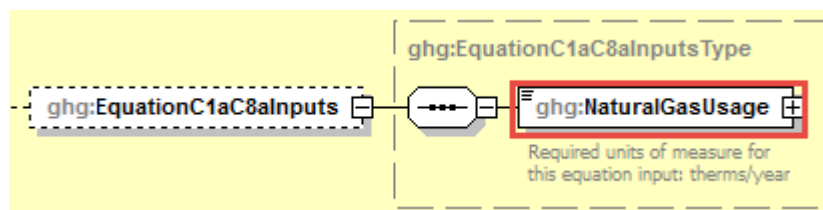

**Figure 40**  
**Tier 1 Fuel Details Equation C1bC8b Inputs Schema Diagram**

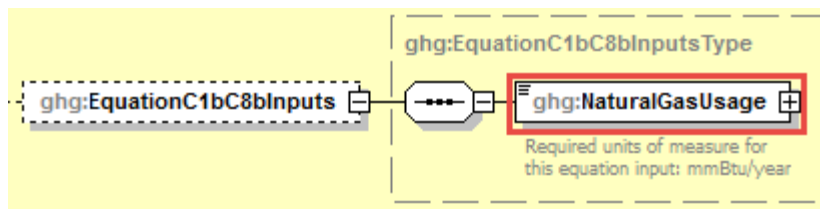

For each fuel type (including biomass fuel(s)) for which you have elected to use a **Tier 1 (Equation C-1, C-1a or C-1b)** methodology, Subpart C requires you to report the following information by fuel type:

**Note:** Only inputs for one equation type may be entered.

- If using Equations C-1 and C-8:
  - The fuel quantity (short tons/year if solid, gallons/year if liquid, scf/year if gas)
  - If your fuels is Wood or Wood Residuals use UseDefaultHHV flag to indicate whether you will use the default HHV (true) or have chosen to report a Moisture Adjusted HHV (false).
  - If you have chosen a UseDefaultHHV of false then report a MoistureContent as a percent.
  - If you have chosen a UseDefaultHHV of false then report a calculated MoistureAdjustedHighHeatValue (mmBtu/short ton).
  - Whether the default CH<sub>4</sub> emission factor (“True”) or .001 kg/mmBtu (“False”) was used for facilities in the IPCC “Energy Industry” category that are using coal fuels.
- If using Equations C-1a and C-8a:
  - Natural gas usage in therms/year.
- If using Equations C-1b and C-8b:
  - Natural gas usage in mmBtu/year.

**Table 28**  
**Tier 1 Equation Inputs Data Element Definitions**

Data Element Name	Description
<b>EquationC1C8Inputs</b>	<b>Parent Element: (Conditionally Required)</b> A collection of data elements to enter if using Equation C-1 and Equation C-8
FuelQuantity	<b>Conditionally Required:</b> If using Equation C-1 and Equation C-8, specify the fuel quantity. (UOM: short tons/year if solid, gallons/year if liquid, scf/year if gas)
UseDefaultHHV	<b>Conditionally Required:</b> If using Equation C-1 and Equation C-8, and the fuel is Wood and Wood Residuals use UseDefaultHHV flag to indicate whether you will use the default HHV (true) or have chosen to report a Moisture Adjusted HHV (false)
MoistureContent	<b>Conditionally Required:</b> If you have chosen a UseDefaultHHV of true then report a MoistureContent of Wood and Wood Residuals as a percent.



MoistureAdjustedHighHeatValue	<b>Conditionally Required:</b> If you have chosen a UseDefaultHHV of true then report a MoistureAdjustedHighHeatValue (mmBtu/short ton).
UseDefaultCh4Ef	<b>Conditionally Required:</b> If using Equation C-1 and Equation C-8, indicate “True” if using the default CH <sub>4</sub> emission factor or “False” if .001 kg/mmBtu was used for facilities in the IPCC “Energy Industry” category that are using coal fuels.
<b>EquationC1aC8aInputs</b>	<b>Parent Element: (Conditionally Required)</b> A collection of data elements to enter if using Equation C-1a and Equation C-8a
NaturalGasUsage	<b>Conditionally Required:</b> If using Equation C-1a and Equation C-8a, specify the natural gas usage in therms/year.
<b>EquationC1bC8bInputs</b>	<b>Parent Element: (Conditionally Required)</b> A collection of data elements to enter if using Equation C-1b and Equation C-8b
NaturalGasUsage	<b>Conditionally Required:</b> If using Equation C-1b and Equation C-8b, specify the natural gas usage in mmBtu/year.

### XML Excerpt 25 Example for Equation C1C8 Inputs

```
<ghg:EquationC1C8Inputs>
  <ghg:FuelQuantity massUOM="scf/year">150</ghg:FuelQuantity>
  <ghg:UseDefaultCh4Ef>True</ghg:UseDefaultCh4Ef>
</ghg:EquationC1C8Inputs>
```

### XML Excerpt 26 Example for Equation C1aC8a Inputs

```
<ghg:EquationC1aC8aInputs>
  <ghg:NaturalGasUsage massUOM="therms/year">150</ghg:NaturalGasUsage>
</ghg:EquationC1aC8aInputs>
```

### XML Excerpt 27 Example for Equation C1bC8b Inputs

```
<ghg:EquationC1bC8bInputs>
  <ghg:NaturalGasUsage massUOM="mmBtu/year">150</ghg:NaturalGasUsage>
</ghg:EquationC1bC8bInputs>
```

 See [Section 6.0](#) for instructions on how to report facility level roll-up emissions or see [Section 2.0](#) for instructions on how to report for a different configuration.

## 4.2 Tier 2 Fuel Details

**Figure 41**  
**Tier 2 Fuel Details Schema Diagram**

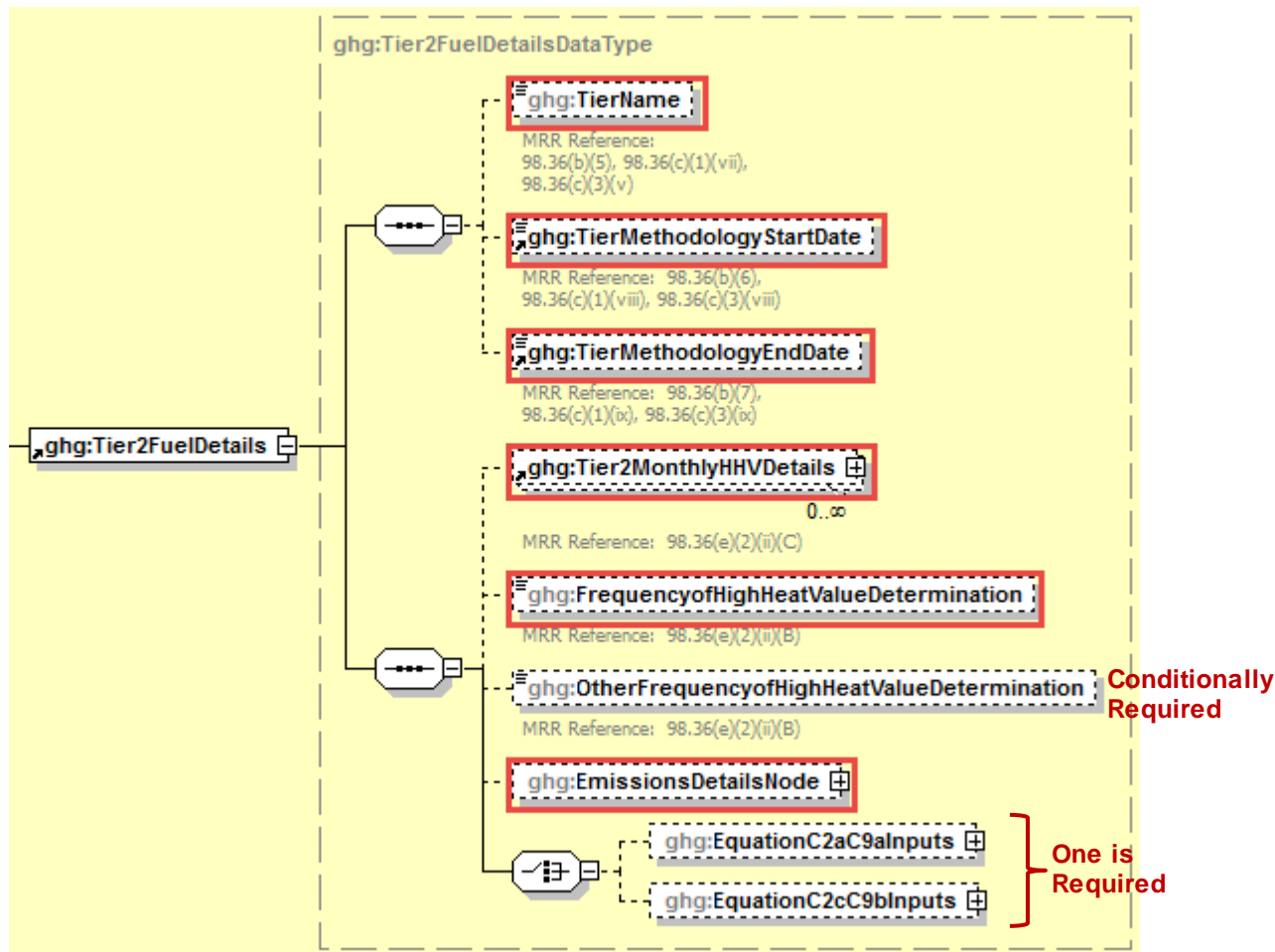

**Note:** Data elements boxed in red are required. Please see page 4 of this document for more information on conditionally required elements.

For each fuel type (including biomass fuel(s)) in a configuration that uses **Tier 2**, you will be required to specify which Tier 2 equation is used to calculate CO<sub>2</sub> emissions.

The following information is required for each fuel type combusted in the unit:

- Calculation methodology used for the emissions calculation period specified, for each fuel type [98.36(b)(5), 98.36(c)(1)(vii), 98.36(c)(3)(v)]:
  - Tier 2/Equation C-2a - Annual fuel combusted, measured heating value and default CO<sub>2</sub> emission factor
  - Tier 2/Equation C-2c – Steam generation, ratio of maximum rated heat input capacity to design rated steam output capacity and default CO<sub>2</sub> emission factor (for MSW and solid fuels listed in Table C-1))

- Calculation methodology start date and end date for each fuel type [98.36(b)(6)-(7), 98.36(c)(1)(viii)-(ix), 98.36(c)(3)(viii)-(ix)]

**Table 29**  
**Tier 2 Fuel Details Data Element Definitions**

Data Element Name	Description
<b>Tier2FuelDetails</b>	<b>Parent Element (Conditionally Required):</b> Collection of data elements containing details about tier 2 fuel usage.
TierName	The name of the Tier 2 methodology used to calculate emissions for the specified reporting configuration. See list of allowable values:  Tier 2 (Equation C-2a) Tier 2 (Equation C-2c, steam generation)
TierMethodologyStartDate	The methodology start date for the specified fuel type (YYYY-MM-DD).
TierMethodologyEndDate	The methodology end date for the specified fuel type (YYYY-MM-DD).

**XML Excerpt 28**  
**Example for Tier 2 Fuel Details**

```

<ghg:Tier2FuelDetails >
  <ghg:TierName >Tier 2 (Equation C-2a) </ghg:TierName >
  <ghg:TierMethodologyStartDate >2011-01-01 </ghg:TierMethodologyStartDate >
  <ghg:TierMethodologyEndDate >2011-12-31 </ghg:TierMethodologyEndDate >

```

**Note:** The code excerpt above is presented here to demonstrate the concept of reporting greenhouse gas emissions data.

**Figure 42**  
**Tier 2 Monthly HHV Details Schema Diagram**

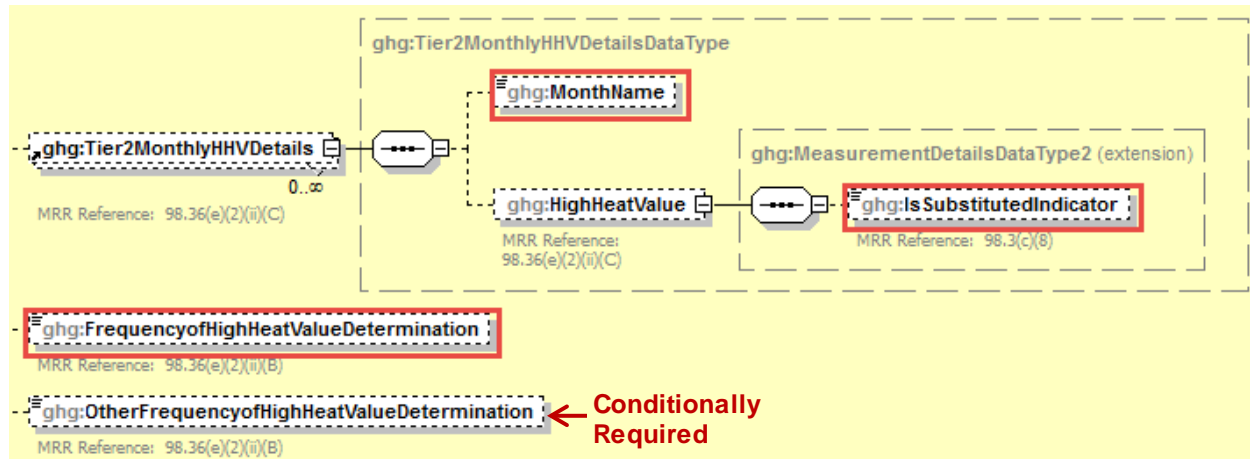

**Note:** Data elements boxed in red are required. Please see page 4 of this document for more information on conditionally required elements.

For each fuel type (including biomass fuel(s)) for which you have elected to use the **Tier 2/Equation C-2a** methodology, Subpart C requires you to report the following information by fuel type:

- Identification of each month for which HHVs were calculated using one or more substitute data values [98.36(e)(2)(ii)(C)]
- The frequency of the HHV determinations [98.36(e)(2)(ii)(B)]
  - Hourly
  - Daily
  - Weekly
  - Monthly
  - Semiannually
  - Quarterly
  - Once per fuel lot
  - Upon addition of oil to the storage tank
  - Other (specify)

**Table 30**  
**Tier 2 Monthly HHV Details Data Element Definitions**

Data Element Name	Description
<b>Tier2MonthlyHHVDetails</b>	<b>Parent Element</b>
MonthName	<p>Specify the name of each month. See list of allowable values:</p> <ul style="list-style-type: none"> <li>January</li> <li>February</li> <li>March</li> <li>April</li> <li>May</li> <li>June</li> <li>July</li> <li>August</li> <li>September</li> <li>October</li> <li>November</li> <li>December</li> </ul>
<b>HighHeatValue</b>	<p><b>Parent Element:</b> For the child data element <b>IsSubstitutedIndicator</b>, indicate (Y/N) whether the HHV value for the specified month was calculated from one or more substitute data values.</p>
FrequencyofHighHeatValueDetermination	<p>The frequency of the HHV determinations. See list of allowable values below. If the frequency you are reporting does not appear in the list, then report "Other (specify)" and then specify the frequency in the OtherFrequencyofHighHeatValueDetermination data element.</p> <ul style="list-style-type: none"> <li>Hourly</li> <li>Daily</li> <li>Weekly</li> <li>Monthly</li> <li>Semiannually</li> <li>Quarterly</li> <li>Once per fuel lot</li> <li>Upon addition of oil to the storage tank</li> <li>Other (specify)</li> </ul>
OtherFrequencyofHighHeatValueDetermination	<p><b>Conditionally Required:</b> The frequency of the HHV determinations if "Other (specify)" is reported. Otherwise do not report this data element.</p>

## XML Excerpt 29

### Example for Tier 2 Monthly HHV Details

```
<ghg:Tier2MonthlyHHVDetails>
  <ghg:MonthName>January</ghg:MonthName>
  <ghg:HighHeatValue>
    <ghg:IsSubstitutedIndicator>Y</ghg:IsSubstitutedIndicator>
  </ghg:HighHeatValue>
</ghg:Tier2MonthlyHHVDetails>
<ghg:Tier2MonthlyHHVDetails>
  <ghg:MonthName>February</ghg:MonthName>
  <ghg:HighHeatValue>
    <ghg:IsSubstitutedIndicator>N</ghg:IsSubstitutedIndicator>
  </ghg:HighHeatValue>
</ghg:Tier2MonthlyHHVDetails>
<ghg:FrequencyofHighHeatValueDetermination>Monthly</ghg:FrequencyofHighHeatValueDetermination>
```

**Note:** The code excerpt above is presented here to demonstrate the concept of reporting greenhouse gas emissions data.

**Figure 43**  
**Tier 2 Emissions Details Node Schema Diagram**

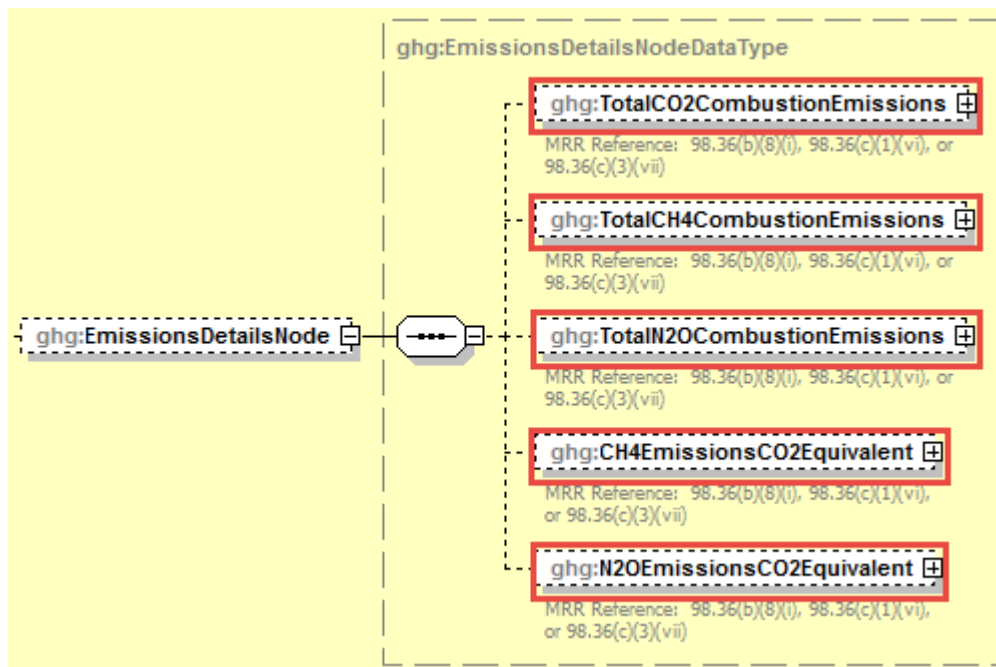

**Note:** Data elements boxed in red are required.

For each fuel type (including biomass fuel(s)) for which you have elected to use the **Tier 2/Equation C-2a** methodology, Subpart C requires you to report the following information by fuel type:

- The total annual CO<sub>2</sub> mass emissions derived from Equation C-2a, in metric tons CO<sub>2</sub> (this value will include both non-biogenic and biogenic CO<sub>2</sub> as applicable) [98.36(b)(8)(i), 98.36(c)(1)(vi), 98.36(c)(3)(vii)]
- The total annual CH<sub>4</sub> mass emissions derived from Equation C-9a, in metric tons CH<sub>4</sub> and in metric tons CO<sub>2</sub>e (for Table C-2 fuels only) [98.36(b)(8)(i), 98.36(c)(1)(vi), 98.36(c)(3)(vii)]
- The total annual N<sub>2</sub>O mass emissions derived from Equation C-9a, in metric tons N<sub>2</sub>O and in metric tons CO<sub>2</sub>e (for Table C-2 fuels only) [98.36(b)(8)(i), 98.36(c)(1)(vi), 98.36(c)(3)(vii)]

For each fuel type (including biomass fuel(s)) for which you have elected to use the **Tier 2/Equation C-2c** methodology, Subpart C requires you to report the following information by fuel type:

- The total annual CO<sub>2</sub> mass emissions derived from Equation C-2c, in metric tons CO<sub>2</sub> (this value will include both non-biogenic and biogenic CO<sub>2</sub> as applicable) [98.36(b)(8)(i), 98.36(c)(1)(vi), 98.36(c)(3)(vii)]
- The total annual CH<sub>4</sub> mass emissions derived from Equation C-9b, in metric tons CH<sub>4</sub> and in metric tons CO<sub>2</sub>e (for Table C-2 fuels only) [98.36(b)(8)(i), 98.36(c)(1)(vi), 98.36(c)(3)(vii)]
- The total annual N<sub>2</sub>O mass emissions derived from Equation C-9b, in metric tons N<sub>2</sub>O and in metric tons CO<sub>2</sub>e (for Table C-2 fuels only) [98.36(b)(8)(i), 98.36(c)(1)(vi), 98.36(c)(3)(vii)]

**Table 31**  
**Tier 2 Monthly HHV Details Emissions Details Node Data Element Definitions**

Data Element Name	Description
<b>EmissionsDetailsNode</b>	<b>Parent Element:</b> A collection of data elements containing the annual CO <sub>2</sub> , CH <sub>4</sub> and N <sub>2</sub> O mass emissions from combustion of the specific fuel type in the unit configuration. Express in metric tons of the specific gas and in metric tons of CO <sub>2</sub> e.
TotalCO2CombustionEmissions	The total annual CO <sub>2</sub> mass emissions (including biogenic and non-biogenic CO <sub>2</sub> ) for the specified fuel combusted in the reporting configuration, calculated using Equation C-2a or C-2c Report the value in the child data element <b>CalculatedValue</b> . Set the units of measure to “Metric Tons” in the attribute <b>massUOM</b> .
TotalCH4CombustionEmissions	The total annual CH <sub>4</sub> mass emissions for the specified fuel combusted in the reporting configuration, calculated using Equation C-9a or C-9b. Report the value in the child data element <b>CalculatedValue</b> . Set the units of measure to “Metric Tons” in the attribute <b>massUOM</b> .
TotalN2OCombustionEmissions	The total annual N <sub>2</sub> O mass emissions for the specified fuel combusted in the reporting configuration, calculated using Equation C-9a or C-9b expressed in mass of N <sub>2</sub> O. Report the value in the child data element <b>CalculatedValue</b> . Set the units of measure to “Metric Tons” in the attribute <b>massUOM</b> .
CH4EmissionsCO2Equivalent	The annual CH <sub>4</sub> mass emissions for the specified fuel combusted in the reporting configuration, expressed in CO <sub>2</sub> e. Multiply the calculated value for CH <sub>4</sub> emissions by the Global Warming Potential of 25 for reporting year 2013 and onward or 21 for reporting years 2010-2012 to arrive at the CO <sub>2</sub> e of the CH <sub>4</sub> emissions. Report the value in the child data element <b>CalculatedValue</b> . Set the units of measure to “Metric Tons” in the attribute <b>massUOM</b> .
N2OEmissionsCO2Equivalent	The annual N <sub>2</sub> O mass emissions for the specified fuel combusted in the reporting configuration, expressed in CO <sub>2</sub> e. Multiply the calculated value for N <sub>2</sub> O emissions by the Global Warming Potential of 298 for reporting year 2013 and onward or 310 for reporting years 2010-2012 to arrive at the CO <sub>2</sub> e of the N <sub>2</sub> O emissions. Report the value in the child data element <b>CalculatedValue</b> . Set the units of measure to “Metric Tons” in the attribute <b>massUOM</b> .



### XML Excerpt 30

#### Example for Tier 2 Monthly HHV Details Emissions Details Node

```
<ghg:EmissionsDetailsNode >
  <ghg:TotalCO2CombustionEmissions massUOM="Metric Tons">
    <ghg:CalculatedValue>2200.4</ghg:CalculatedValue>
  </ghg:TotalCO2CombustionEmissions >
  <ghg:TotalCH4CombustionEmissions massUOM="Metric Tons">
    <ghg:CalculatedValue>220.73</ghg:CalculatedValue>
  </ghg:TotalCH4CombustionEmissions >
  <ghg:TotalN2OCombustionEmissions massUOM="Metric Tons">
    <ghg:CalculatedValue>22.576</ghg:CalculatedValue>
  </ghg:TotalN2OCombustionEmissions >
  <ghg:CH4EmissionsCO2Equivalent massUOM="Metric Tons">
    <ghg:CalculatedValue>4620.8</ghg:CalculatedValue>
  </ghg:CH4EmissionsCO2Equivalent >
  <ghg:N2OEmissionsCO2Equivalent massUOM="Metric Tons">
    <ghg:CalculatedValue>6820.1</ghg:CalculatedValue>
  </ghg:N2OEmissionsCO2Equivalent >
</ghg:EmissionsDetailsNode >
```

**Note:** The code excerpt above is presented here to demonstrate the concept of reporting greenhouse gas emissions data.

**Figure 44**  
**EquationC2aC9a Inputs Schema Diagram**

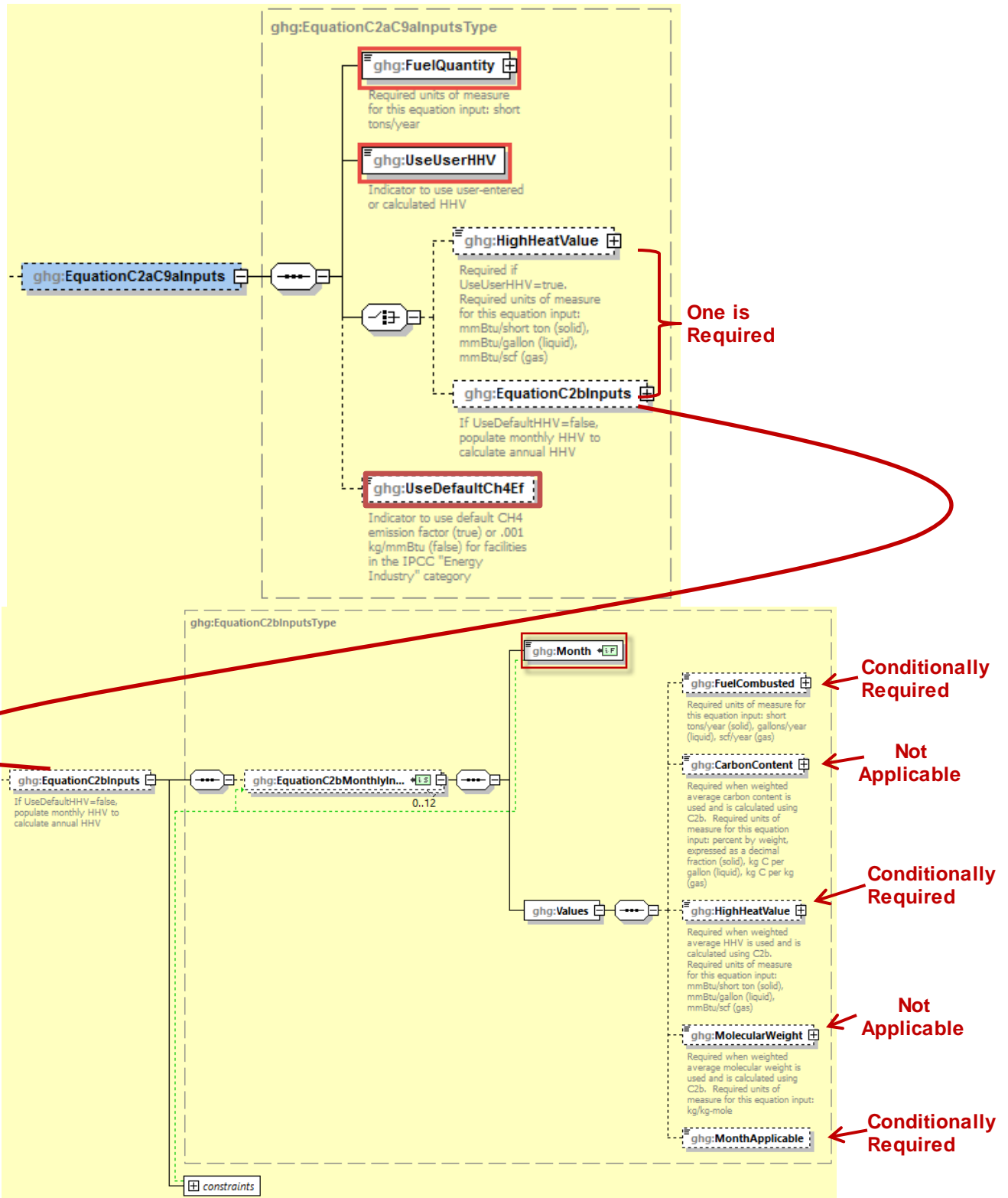
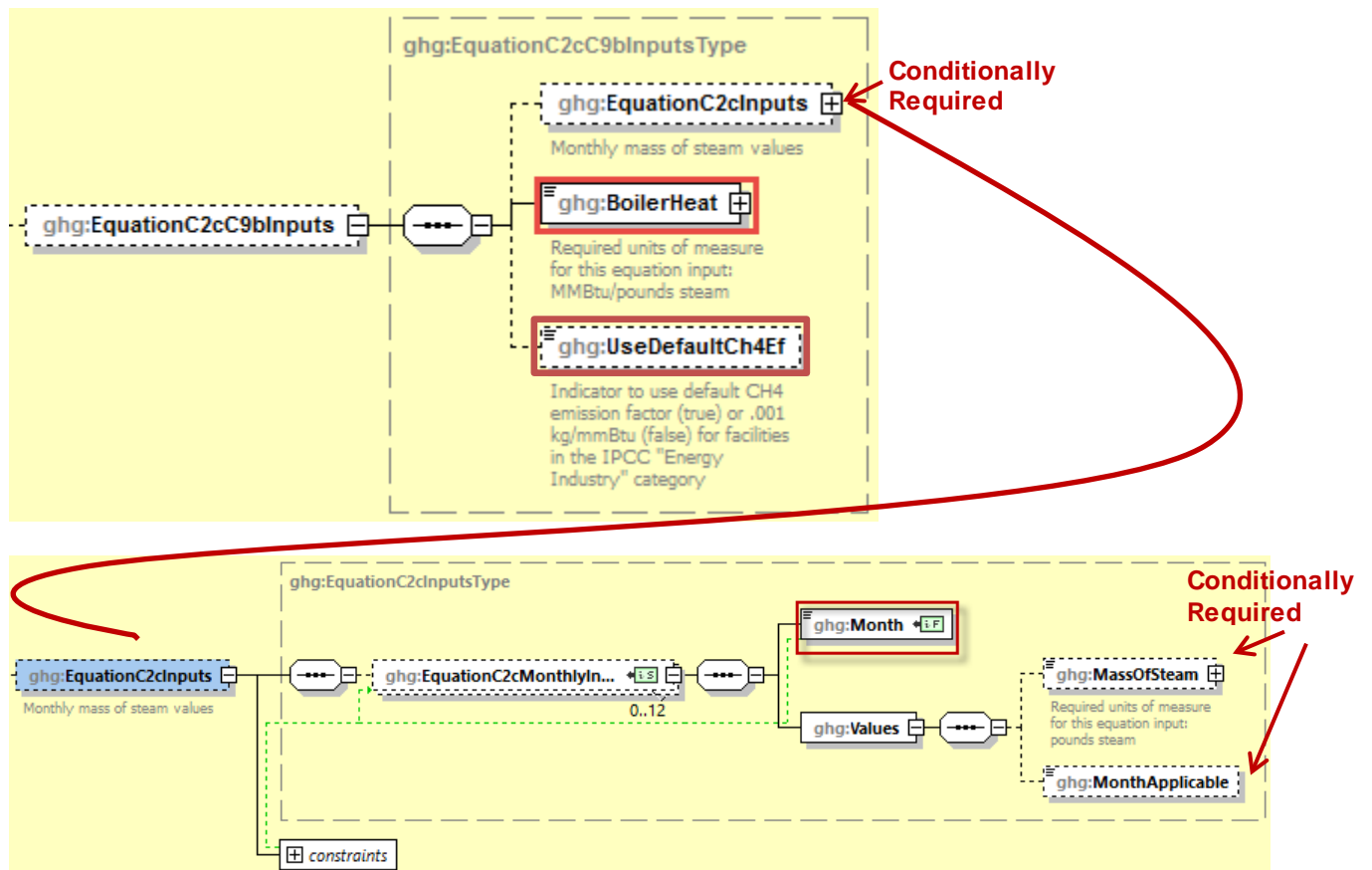

**Table 32**  
**Tier 2 Equation C2aC9a Data Element Definitions**

Data Element Name	Description
<b>EquationC2aC9aInputs</b>	<b>Parent Element: (Conditionally Required)</b> If using Equations C-2a and C-9a, a collection of data elements to enter for Tier 2
FuelQuantity	Specify the fuel quantity in short tons/year for a solid, gallons/year for a liquid, or scf/year for a gas.
UseUserHHV	Indicate “True” if using user-entered HHV or “False” if high heat value will be calculated.
HighHeatValue	<b>Conditionally Required:</b> If UseUserHHV = “True”, specify the high heat value in mmBtu/short ton for a solid, mmBtu/gallon for a liquid, or mmBtu/scf for a gas.
UseDefaultCh4Ef	<b>Required:</b> If the facility is in the IPCC “Energy Industry” category and is using coal fuels, indicate “True” if using the default CH <sub>4</sub> emission factor or “False” if using .001 kg/mmBtu.
<b>EquationC2bInputs</b>	<b>Parent Element:</b> The collection of data elements used to determine the weighted annual average high heat value of the fuel. <b>Conditionally Required:</b> These data elements are used if UseUserHHV = False. These data elements are required if the results of fuel sampling are received monthly or more frequently and the maximum rated heat input capacity of the unit is greater than or equal to 100 mmBtu/hour (or for a group of units containing at least one unit of that size). The user has the option to use Equation C-2b to quantify HHV regardless of sampling frequency for units with a maximum rated capacity less than 100 mmBtu/hour (or a group of such units).
<b>EquationC2bMonthlyInputs</b>	<b>Parent Element:</b> The collection of monthly data elements used to determine the annual average high heat value of the fuel. Required elements below are only required if UseUserHHV is false.
Month	<b>Required:</b> Specify the month for which values are being provided (e.g., “January”, “February”, etc)
<b>Values</b>	<b>Parent Element:</b> A collection of data elements describing fuel combusted and HHV for each month specified.
FuelCombusted	Specify the fuel combusted during the month in units short tons/year if solid, gallons/year if liquid and scf/year if gas. <b>Conditionally Required:</b> If MonthApplicable is True
CarbonContent	<b>Not Applicable:</b> Carbon Content is not used Equation C2aC9a

Data Element Name	Description
HighHeatValue	Specify the measured high heat value of the fuel for the month, which may be the arithmetic average of multiple determinations, or, if applicable, an appropriate substitute data value. (mmBtu/short ton if solid, mmBtu/gallon if liquid, mmBtu/scf if gas).  <b>Conditionally Required:</b> If MonthApplicable is True
MolecularWeight	<b>Not Applicable:</b> MolecularWeight is not used Equation C2aC9a
MonthApplicable	<b>Conditionally Required:</b> True or False. Specify False when a month is not applicable. If this data element is omitted the node is treated as if MonthApplicable is True.

**Figure 45**  
**Equation C2c9b Inputs Schema Diagram**



**Table 33**  
**Tier 2 Equation C2cC9b Data Element Definitions**

Data Element Name	Description
<b>EquationC2cC9bInputs</b>	<b>Parent Element: (Conditionally Required)</b> If using Equations C-2c and C-9b, a collection of data elements to enter for Tier 2
<b>EquationC2cInputs</b>	<b>Parent Element: (Conditionally Required)</b> If using Equation C-2c, a collection of monthly data elements to calculate mass of steam values.
<b>EquationC2cMonthlyInputs</b>	<b>Parent Element:</b> A collection of monthly data elements to calculate mass of steam values.
BoilerHeat	Specify the ratio of the boiler's maximum rated heat input capacity to its design rated steam output capacity (mmBtu/lb steam).
UseDefaultCh4Ef	<b>Required:</b> If the facility is in the IPCC "Energy Industry" category and is using coal fuels, indicate "True" if using the default CH <sub>4</sub> emission factor or "False" if using .001 kg/mmBtu.
Month	<b>Required:</b> Specify the month for which values are being provided (e.g., "January", "February", etc)
<b>Values</b>	<b>Parent Element:</b> A collection of data elements for each month specified.
MassOfSteam	Specify the mass of steam for the month indicated in pounds steam. <b>Conditionally Required:</b> If MonthApplicable is True
MonthApplicable	<b>Conditionally Required:</b> True or False. Specify False when a month is not applicable. If this data element is omitted the node is treated as if MonthApplicable is True.

 See [Section 6.0](#) for instructions on how to report facility level roll-up emissions or see [Section 2.0](#) for instructions on how to report for a different configuration.

### 4.3 Tier 3 Fuel Details

**Figure 46**  
**Tier 3 Fuel Details Schema Diagram**

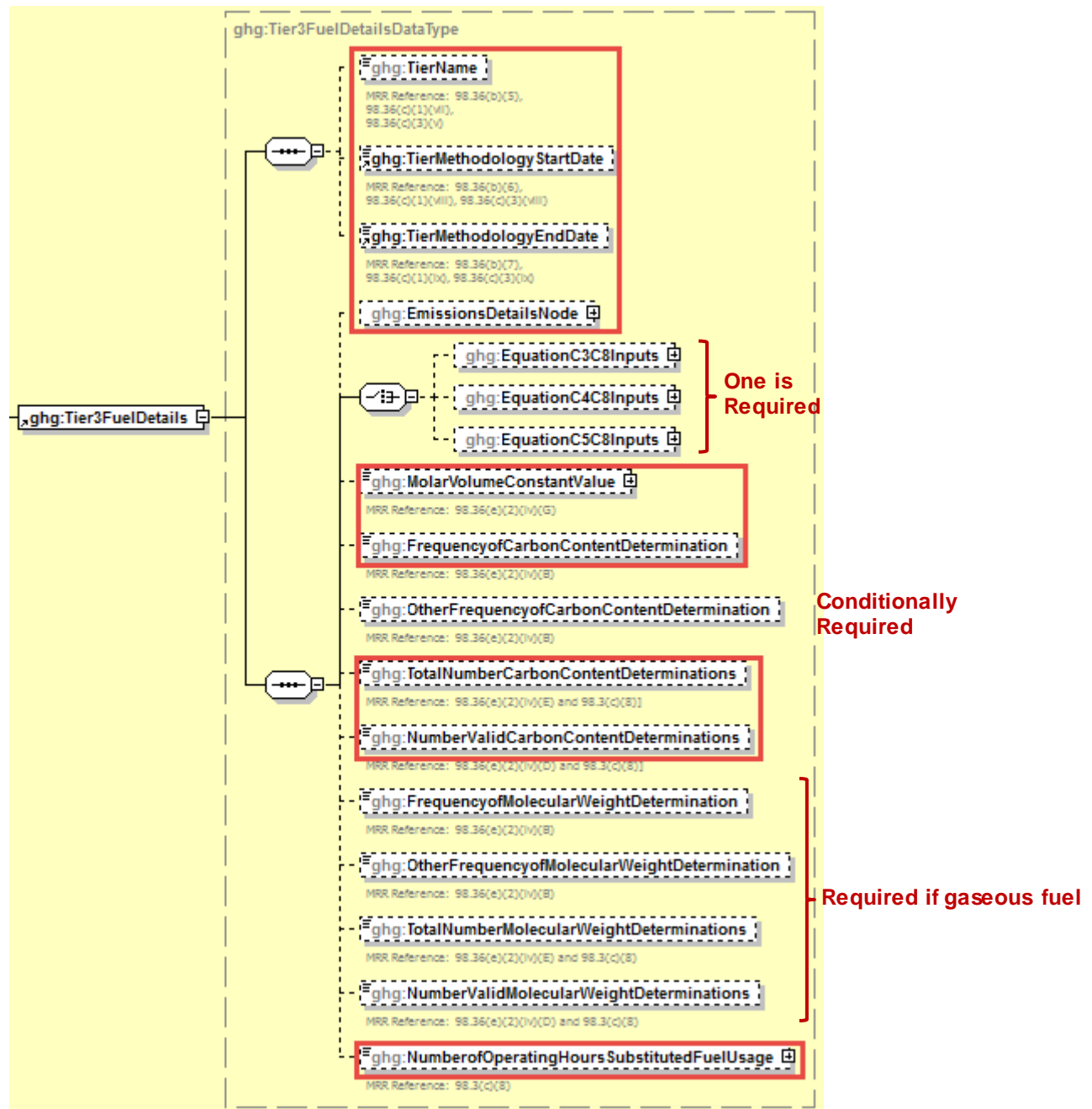

**Note:** Data elements boxed in red are required. Please see page 4 of this document for more information on conditionally required elements.

For each fuel type (including biomass fuel(s)) in a configuration that uses **Tier 3**, you will be required to specify which Tier 3 equation is used to calculate CO<sub>2</sub> emissions.

The following information is required for each fuel type combusted in the unit:

- Calculation methodology used for the emissions calculation period specified, for each fuel type [98.36(b)(5), 98.36(c)(1)(vii), 98.36(c)(3)(v)]:
  - Tier 3/Equation C-3 – Annual mass of solid fuel combusted and average carbon content of the solid fuel
  - Tier 3/Equation C-4 – Annual mass of liquid fuel combusted and average carbon content of the liquid fuel
  - Tier 3/Equation C-5 – Annual volume of gaseous fuel combusted, average carbon content of the gaseous fuel and average molecular weight of the gaseous fuel
- Calculation methodology start date and end date, for each fuel type [98.36(b)(6)-(7), 98.36(c)(1)(viii)-(ix), 98.36(c)(3)(viii)-(ix)]

**Table 34**  
**Tier 3 Fuel Details Data Element Definitions**

Data Element Name	Description
<b>Tier3FuelDetails</b>	<b>Parent Element (Conditionally Required):</b> Collection of data elements containing details about tier 3 fuel usage.
TierName	The name of the Tier 3 methodology used to calculate emissions for the specified unit or unit configuration. See list of allowable values:  Tier 3 (Equation C-3, solid fuel) Tier 3 (Equation C-4, liquid fuel) Tier 3 (Equation C-5, gaseous fuel)
TierMethodologyStartDate	The methodology start date for the specified fuel type (YYYY-MM-DD).
TierMethodologyEndDate	The methodology end date for the specified fuel type (YYYY-MM-DD).

**XML Excerpt 31**  
**Example for Tier 3 Fuel Details**

```

<ghg:Tier3FuelDetails>
  <ghg:TierName>Tier 3 (Equation C -5, gaseous fuel)</ghg:TierName>
  <ghg:TierMethodologyStartDate>2011-01-01</ghg:TierMethodologyStartDate>
  <ghg:TierMethodologyEndDate>2011-12-31</ghg:TierMethodologyEndDate>

```

**Note:** The code excerpt above is presented here to demonstrate the concept of reporting greenhouse gas emissions data.

**Figure 47**  
**Tier 3 Emissions Details Node Schema Diagram**

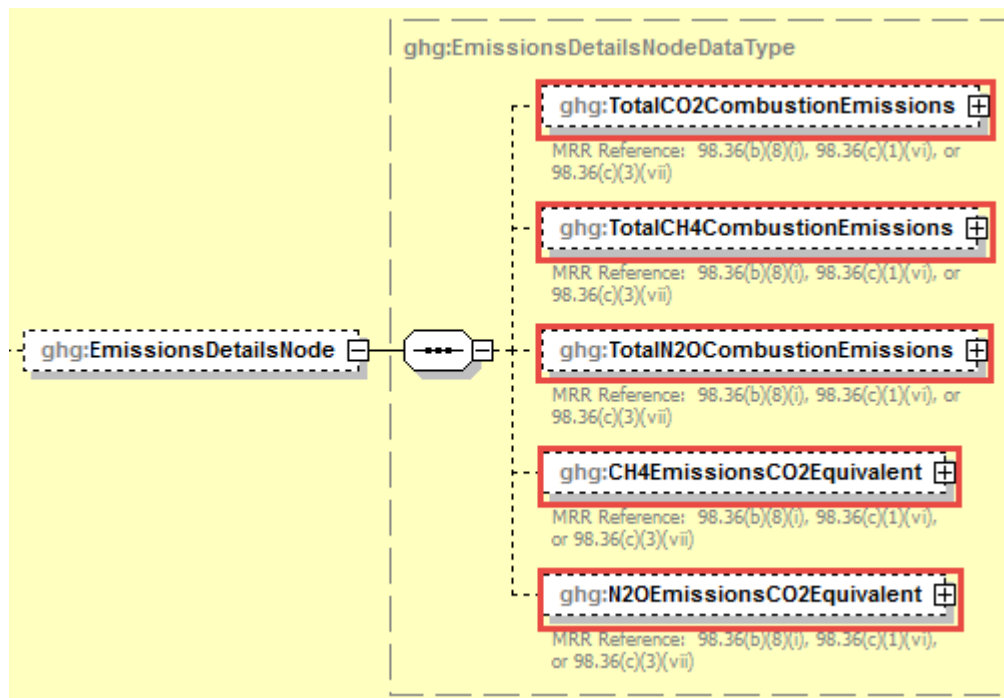

Note: Data elements boxed in red are required.

For each fuel type (including biomass fuel(s)) for which you have elected to use a **Tier 3 (Equation C-3, C-4 or C-5)** methodology, Subpart C requires you to report the following information by fuel type:

- The total annual CO<sub>2</sub> mass emissions derived from Equation C-3 for solid fuels, Equation C-4 for liquid fuels or Equation C-5 for gaseous fuels, in metric tons CO<sub>2</sub> (this value will include both non-biogenic and biogenic CO<sub>2</sub> as applicable) [98.36(b)(8)(i), 98.36(c)(1)(vi), 98.36(c)(3)(vii)]
- The total annual CH<sub>4</sub> mass emissions derived from Equation C-8, in metric tons CH<sub>4</sub> and in metric tons CO<sub>2</sub>e (for Table C-2 fuels only) [98.36(b)(8)(i), 98.36(c)(1)(vi), 98.36(c)(3)(vii)]
- The total annual N<sub>2</sub>O mass emissions derived from Equation C-8, in metric tons N<sub>2</sub>O and in metric tons CO<sub>2</sub>e (for Table C-2 fuels only) [98.36(b)(8)(i), 98.36(c)(1)(vi), 98.36(c)(3)(vii)]



**Table 35**  
**Tier 3 Fuel Details Emissions Details Node Data Element Definitions**

Data Element Name	Description
<b>EmissionsDetailsNode</b>	<b>Parent Element:</b> A collection of data elements containing inputs for equations related to Tier 3 fuel usage.
TotalCO2CombustionEmissions	<b>Parent Element:</b> The total annual CO <sub>2</sub> mass emissions (including biogenic and non-biogenic CO <sub>2</sub> ) for the specified fuel combusted in the reporting configuration, calculated using Equation C-3, C-4 or C-5. Report the value in the child data element <b>CalculatedValue</b> . Set the units of measure to “Metric Tons” in the attribute <b>massUOM</b> .
TotalCH4CombustionEmissions	<b>Parent Element:</b> The total annual CH <sub>4</sub> mass emissions for the specified fuel combusted in the reporting configuration, calculated using Equation C-8. Report the value in the child data element <b>CalculatedValue</b> . Set the units of measure to “Metric Tons” in the attribute <b>massUOM</b> .
TotalN2OCombustionEmissions	<b>Parent Element:</b> The total annual N <sub>2</sub> O mass emissions for the specified fuel combusted in the reporting configuration, calculated using Equation C-8. Report the value in the child data element <b>CalculatedValue</b> . Set the units of measure to “Metric Tons” in the attribute <b>massUOM</b> .
CH4EmissionsCO2Equivalent	<b>Parent Element:</b> The annual CH <sub>4</sub> mass emissions for the specified fuel combusted in the reporting configuration, expressed in CO <sub>2</sub> e. Multiply the calculated value for CH <sub>4</sub> emissions by the Global Warming Potential of 25 for reporting year 2013 and onward or 21 for reporting years 2010-2012 to arrive at the CO <sub>2</sub> e of the CH <sub>4</sub> emissions. Report the value in the child data element <b>CalculatedValue</b> . Set the units of measure to “Metric Tons” in the attribute <b>massUOM</b> .
N2OEmissionsCO2Equivalent	<b>Parent Element:</b> The annual N <sub>2</sub> O mass emissions for the specified fuel combusted in the reporting configuration, expressed in CO <sub>2</sub> e. Multiply the calculated value for N <sub>2</sub> O emissions by the Global Warming Potential of 298 for reporting year 2013 and onward or 310 for reporting years 2010-2012 to arrive at the CO <sub>2</sub> e of the N <sub>2</sub> O emissions. Report the value in the child data element <b>CalculatedValue</b> . Set the units of measure to “Metric Tons” in the attribute <b>massUOM</b> .

**Figure 48**  
**Tier 3 Equation Inputs Schema Diagram**

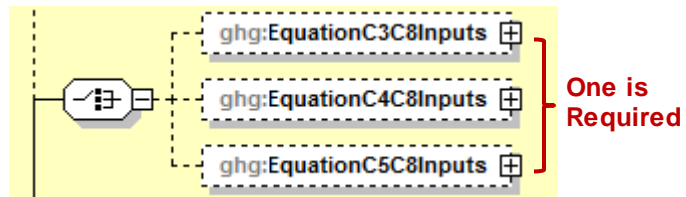

**Figure 49**  
**Tier 3 Equation C3C8 Inputs Schema Diagram**

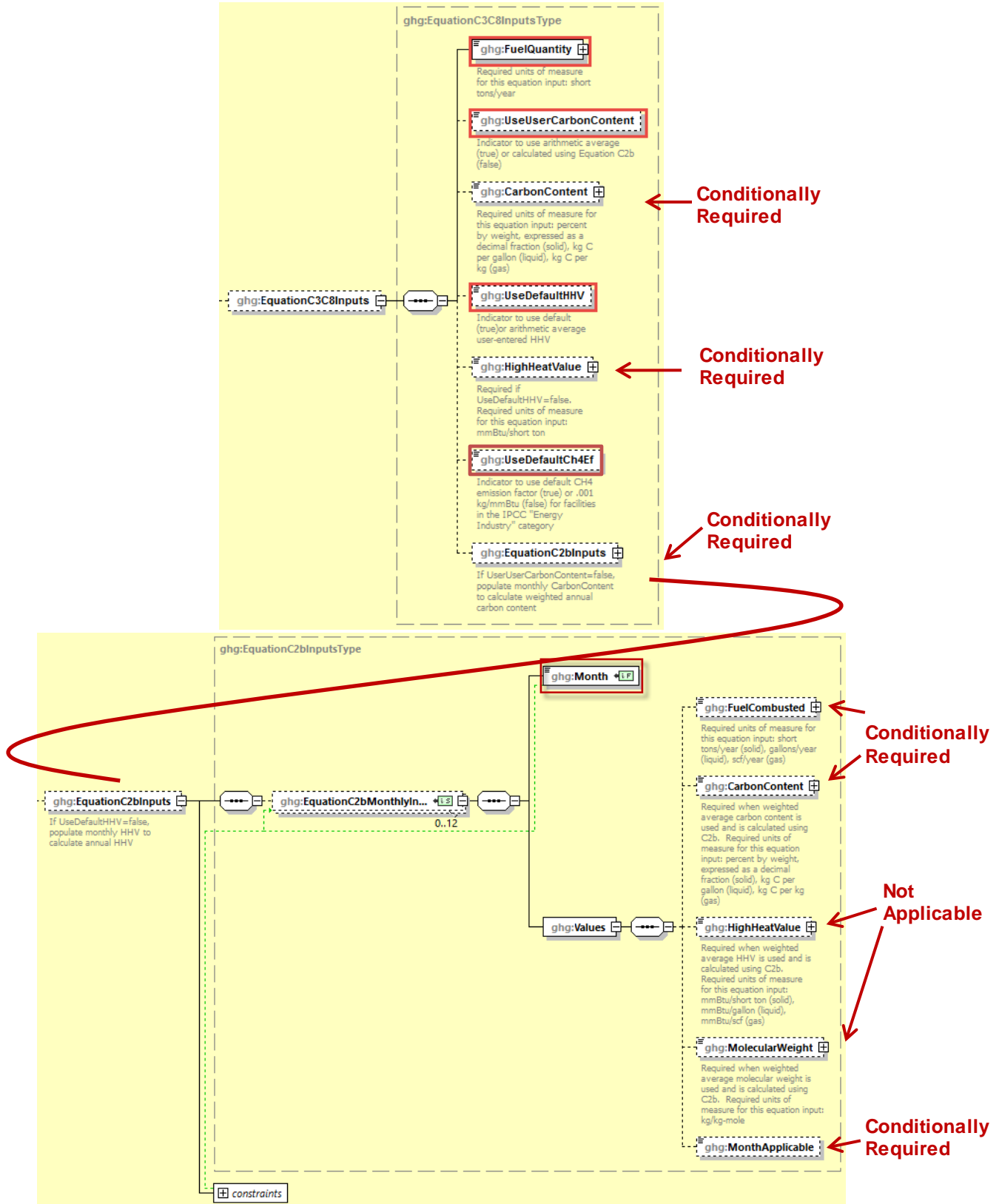
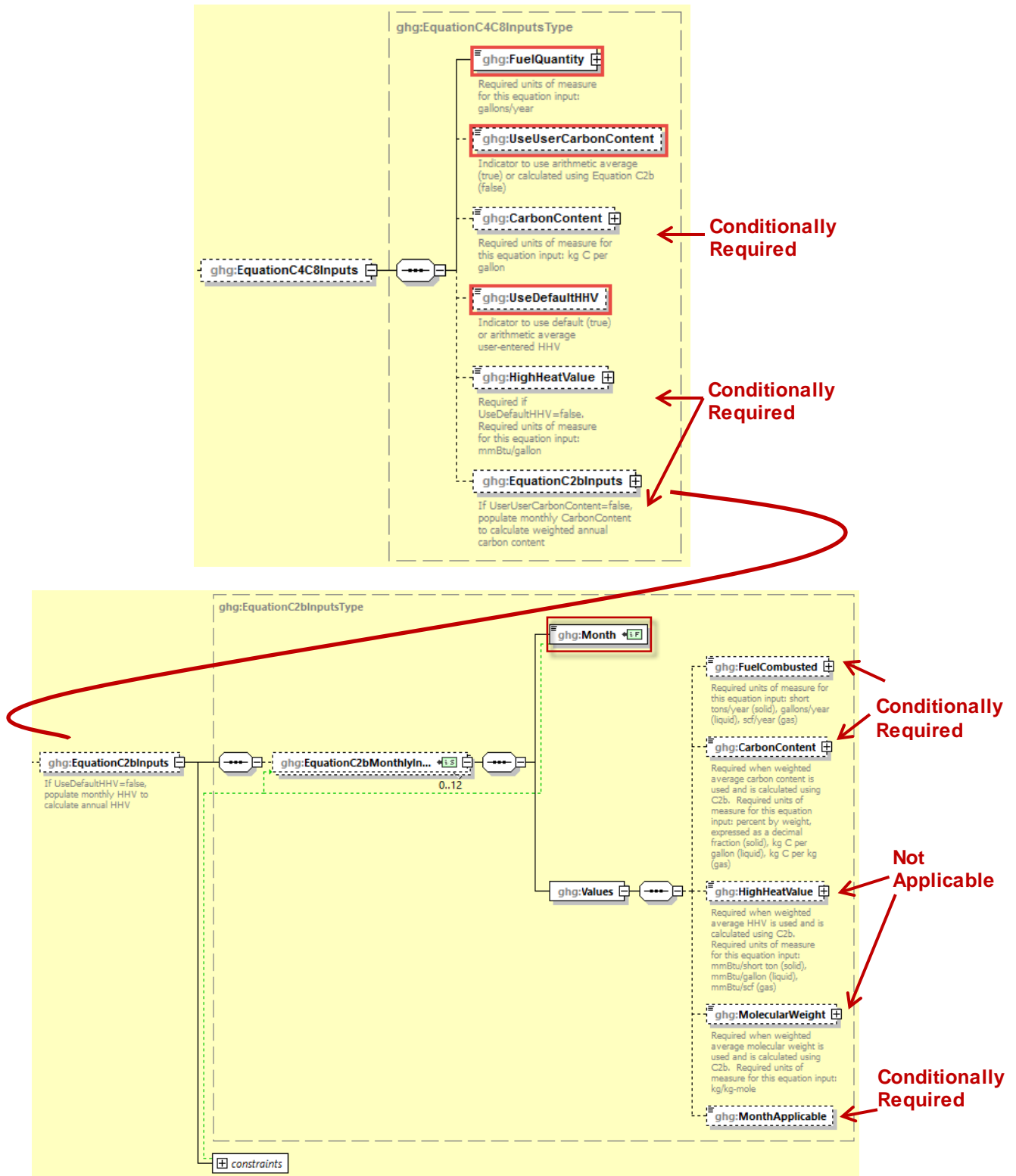

**Table 36**  
**Tier 3 Equation C3C8 Data Element Definitions**

Data Element Name	Description
<b>EquationC3C8Inputs</b>	<b>Parent Element: (Conditionally Required)</b> If using Equations C-3 (for a solid fuel) and C-8, a collection of data elements to enter for Tier 3
FuelQuantity	Specify the fuel quantity in short tons/year
UseUserCarbonContent	Indicate “True” if using arithmetic average carbon content or “False” if carbon content will be calculated using Equation C-2b.
CarbonContent	<b>Conditionally Required:</b> If UseUserCarbonContent = “True”, specify the carbon content in percent by weight, expressed as a decimal fraction for the solid fuel. Required if UseUserCarbonContent is user-entered “True”.
UseDefaultHHV	Indicate “True” if default high heat value is used or “False” if average user-entered high heat value is used.
HighHeatValue	<b>Conditionally Required:</b> If UseDefaultHHV is “False”, specify the high heat value in mmBtu/ton. Required if UseDefaultHHV is “False”.
UseDefaultCh4Ef	<b>Required:</b> If the facility is in the IPCC “Energy Industry” category and is using coal fuels, indicate “True” if using the default CH <sub>4</sub> emission factor or “False” if using .001 kg/mmBtu.
<b>EquationC2bInputs</b>	<b>Parent Element:</b> The collection of data elements used to determine the weighted annual average carbon content of the fuel. <b>Conditionally Required:</b> These data elements are used if UseUserCarbonContent= False.
<b>EquationC2bMonthlyInputs</b>	<b>Parent Element:</b> A collection of monthly data elements to calculate weighted annual average carbon content.
Month	<b>Required:</b> Specify the month for which values are being provided (e.g., “January”, “February”, etc)
<b>Values</b>	<b>Parent Element:</b> A collection of data elements describing fuel combusted and carbon content for each month specified.
FuelCombusted	Specify the mass of the fuel combusted during the month from company records (using short tons for solid fuel) <b>Conditionally Required:</b> If MonthApplicable is True

Data Element Name	Description
CarbonContent	Specify the carbon content of the fuel for the month in percent by weight, expressed as a decimal fraction (solid). <b>Conditionally Required:</b> If MonthApplicable is True
HighHeatValue	<b>Not Applicable:</b> HighHeatValue cannot be reported by month in Eq-C3C8. Please use the default HHV or report annual weighted average HighHeatValue as a single value in Eq-C3C8 node.
MolecularWeight	<b>Not Applicable:</b> MolecularWeight is not used Equation C3C8
MonthApplicable	<b>Conditionally Required:</b> True or False. Specify False when a month is not applicable. If this data element is omitted the node is treated as if MonthApplicable is True.

**Figure 50**  
**Tier 3 Equation C4C8 Inputs Schema Diagram**



**Table 37**  
**Tier 3 Equation C4C8 Data Element Definitions**

Data Element Name	Description
<b>EquationC4C8Inputs</b>	<b>Parent Element: (Conditionally Required)</b> If using Equations C-4 (for a liquid fuel) and C-8, a collection of data elements to enter for Tier 3
FuelQuantity	Specify the fuel quantity in gallons/year
UseUserCarbonContent	Indicate “True” if using user-entered carbon content or “False” if using Equation C-2b to calculate weighted average carbon content.
CarbonContent	<b>Conditionally Required:</b> If UseUserCarbonContent = “True”, specify the carbon content in percent by weight, expressed as a decimal fraction for the solid fuel.
UseDefaultHHV	Indicate “True” if default high heat value is used or “False” if average user-entered high heat value is used.
HighHeatValue	Specify the high heat value in mmBtu/gallon. <b>Conditionally Required:</b> Used if “UseDefaultHHV” is “False”. Specify the high heat value in mmBtu/ton. Required if UseDefaultHHV is “False”.
<b>EquationC2bInputs</b>	<b>Parent Element:</b> The collection of data elements used to determine the weighted annual average carbon content of the fuel. <b>Conditionally Required:</b> These data elements are used if UseDefaultCarbonContent = False.
<b>EquationC2bMonthlyInputs</b>	<b>Parent Element:</b> The collection of monthly data elements used to determine the annual average carbon content of the liquid fuel.
Month	<b>Required:</b> Specify the month for which values are being provided (e.g., “January”, “February”, etc)
<b>Values</b>	<b>Parent Element:</b> A collection of data elements describing fuel combusted and carbon content for each month specified.
FuelCombusted	Specify the volume of the fuel combusted during the month from company records (using gallons for liquid fuel.) <b>Conditionally Required:</b> If MonthApplicable is True
CarbonContent	<b>Conditionally Required:</b> If UseUserCarbonContent = “True”, specify the carbon content in fraction by weight, expressed as a decimal fraction for the solid fuel. Required if UseUserCarbonContent is user-entered “True”.

Data Element Name	Description
HighHeatValue	<b>Not Applicable:</b> HighHeatValue cannot reported by month in Eq C4C8. Please use the default HHV or report annual weighted average HighHeatValue as a single value in Eq-C4C8 node.
MolecularWeight	<b>Not Applicable:</b> MolecularWeight is not used Equation C4C8.
MonthApplicable	<b>Conditionally Required:</b> True or False. Specify False when a month is not applicable. If this data element is omitted the node is treated as if MonthApplicable is True.



**Figure 51**  
**Tier 3 Equation C5C8 Inputs Schema Diagram**

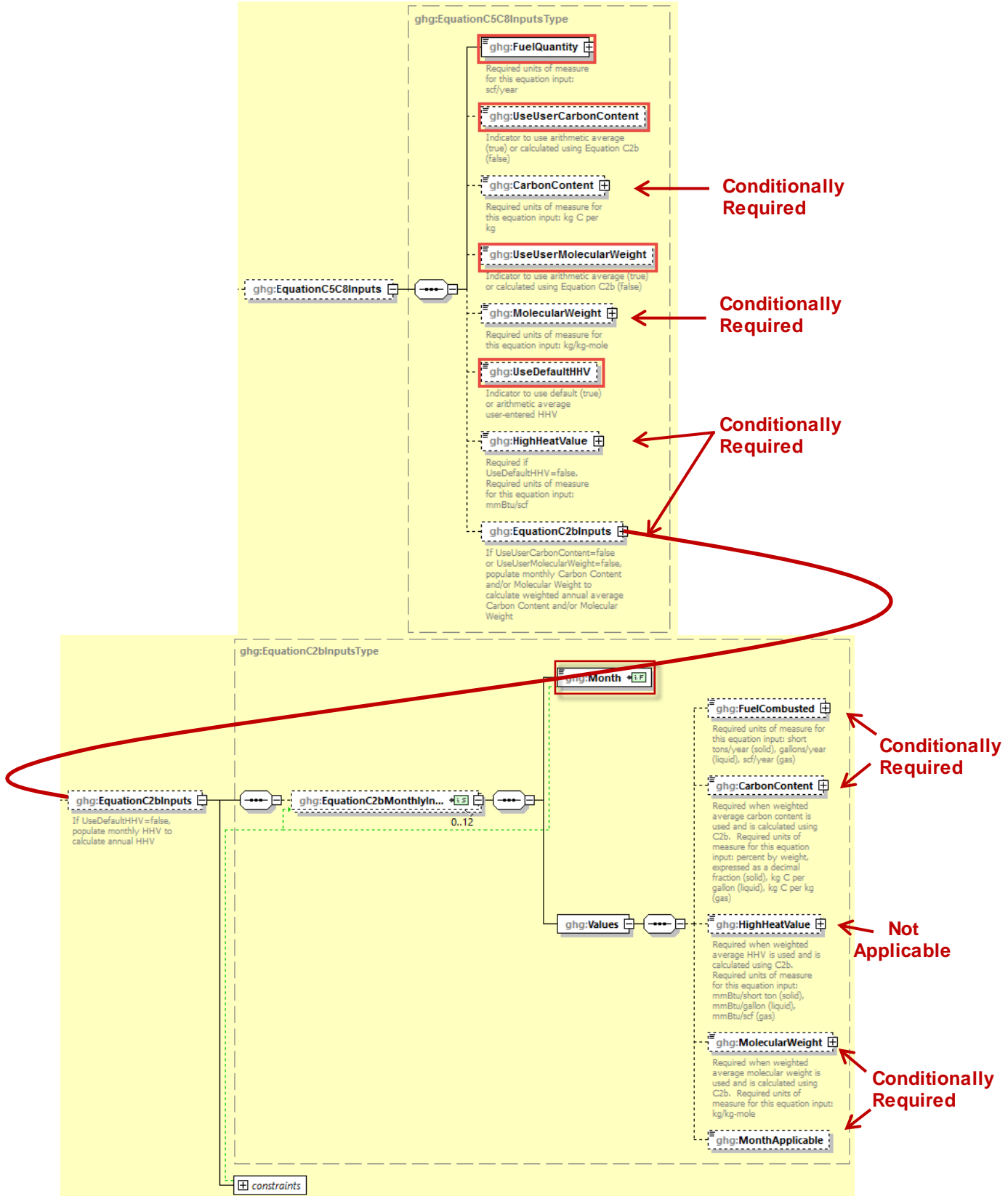
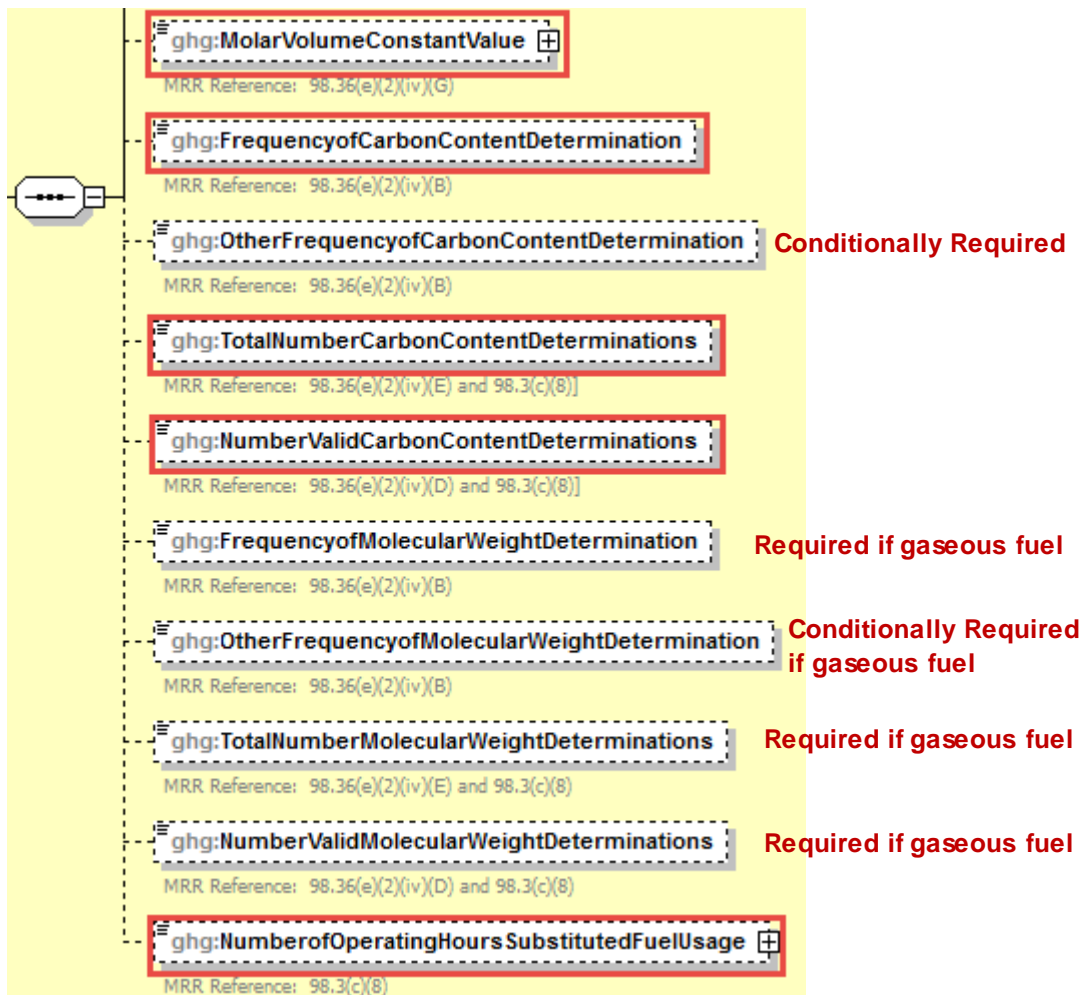

**Table 38**  
**Tier 3 Equation C5C8 Data Element Definitions**

Data Element Name	Description
<b>EquationC5C8Inputs</b>	<b>Parent Element: (Conditionally Required)</b> For a gaseous fuel, if using Equations C-5 and C-8, a collection of data elements to enter for Tier 3
FuelQuantity	Specify the total volume of fuel consumed, in standard cubic feet per year.
UseUserCarbonContent	Indicate “True” if using arithmetic average carbon content or “False” if carbon content will be calculated using Equation C-2b
CarbonContent	Specify the carbon content of the gaseous fuel in kg C per kg of gaseous fuel <b>Conditionally Required:</b> Used if “UseUserCarbonContent” is “True.”
UseUserMolecularWeight	Indicate “True” if using user-entered molecular weight or “False” if using Equation C-2b to calculate weighted annual average molecular weight.
MolecularWeight	Specify the molecular weight for the fuel consumed, in kg/kg-mole. <b>Conditionally Required:</b> Used if “UseUserMolecularWeight” is “True.”
UseDefaultHHV	Indicate “True” if default high heat value is used or “False” if average user-entered high heat value is used..
HighHeatValue	Specify the high heat value in mmBtu/scf. <b>Conditionally Required:</b> Used if “UseDefaultHHV” is “False.”
<b>EquationC2bInputs</b>	<b>Parent Element:</b> The collection of data elements used to determine the weighted annual average carbon content and/or molecular weight of the gaseous fuel. <b>Conditionally Required:</b> These data elements are used if UseDefaultCarbonContent = False, UseUserMolecularWeight = False.
<b>EquationC2bMonthlyInputs</b>	<b>Parent Element:</b> A collection of monthly data elements to calculate weighted annual carbon content and/or molecular weight.
Month	<b>Required:</b> Specify the month for which values are being provided (e.g., “January”, “February”, etc)
<b>Values</b>	<b>Parent Element:</b> A collection of data elements describing fuel combusted, and carbon content and/or molecular weight for each month specified.

Data Element Name	Description
FuelCombusted	Specify the volume of the fuel combusted during the month from company records (using standard cubic feet) <b>Conditionally Required:</b> If MonthApplicable is True
CarbonContent	<b>Conditionally Required:</b> If using weighted average carbon content calculated using Equation C-2b, specify the carbon content for each month. Units of measure are kg C per kg for the gaseous fuel.
HighHeatValue	<b>Not Applicable:</b> HighHeatValue cannot be reported by month in Eq- C5C8. Please use the default HHV or report annual weighted average HighHeatValue as a single value in Eq-C5C8 node.
MolecularWeight	Specify the molecular weight for the month in kg/kg-mole. <b>Conditionally Required:</b> If MonthApplicable is True and UseUserMolecularWeight is False
MonthApplicable	<b>Conditionally Required:</b> True or False. Specify False when a month is not applicable. If this data element is omitted the node is treated as if MonthApplicable is True.

**Figure 52**  
**Additional Tier 3 Fuel Details Schema Diagram**



**Note:** Data elements boxed in red are required. Please see page 4 of this document for more information on conditionally required elements.

For each fuel type (including biomass fuel(s)) for which you have elected to use a **Tier 3 (Equation C-3, C-4 or C-5)** methodology, Subpart C requires you to report the following information by fuel type:

- The value of the molar volume constant used in Equation C-5.
- The frequency of carbon content determinations [98.36(e)(2)(iv)(B)]
  - Hourly
  - Daily
  - Weekly
  - Monthly

- Semiannually
  - Quarterly
  - Once per fuel lot
  - Upon addition of oil to the storage tank
  - Other (specify)
- The total number of carbon content substitute data values [98.36(e)(2)(iv)(E)]
- The total number of valid carbon content determinations [98.36(e)(2)(iv)(D)]
- The total number of operating hours in the reporting year for which missing data substitution was used for fuel usage [98.3(c)(8)]

**Conditionally Required:** For each gaseous fuel at each configuration for which you have elected to use the **Tier 3/Equation C-5 methodology**, Subpart C also requires you to report the following additional information:

- Frequency of molecular weight determinations [98.36(e)(2)(iv)(B)]
  - Hourly
  - Daily
  - Weekly
  - Monthly
  - Semiannually
  - Quarterly
  - Other (specify)
- Frequency of molecular weight determinations [98.36(e)(2)(iv)(B)]
- Total number of molecular weight substitute data values [98.36(e)(2)(iv)(E)] Total number of molecular weight substitute data values [98.36(e)(2)(iv)(E)]
- Total number of valid molecular weight determinations [98.36(e)(2)(iv)(D)]
- The value of the molar volume constant (MVC) at standard conditions [98.36(e)(2)(iv)(G)]

**Table 39**  
**Tier 3 Fuel Details Data Element Definitions**

MolarVolumeConstantValue	<b>Conditionally Required:</b> If Equation C-5 is used, specify the value of the molar volume constant.
FrequencyofCarbonContentDetermination	<p>The frequency of carbon content determinations for the specified fuel for the reporting year. See the list of allowable values below. If the frequency you are reporting does not appear in the list, then report "Other (specify)" and then specify the frequency in the "OtherFrequencyofCarbonContentDetermination" data element.</p> <p>Hourly Daily Weekly Monthly Semiannually Quarterly Once per fuel lot Upon addition of oil to the storage tank Other (specify)</p>
OtherFrequencyofCarbonContentDetermination	<b>Conditionally Required:</b> The frequency of the carbon content determinations if "Other (specify)" is reported. Otherwise, do not report this element.
TotalNumberCarbonContentDeterminations	The total number of substitute data values used for carbon content in the annual GHG emissions calculations.
NumberValidCarbonContentDeterminations	The total number of valid carbon content determinations made during the reporting year for the specified fuel type.
FrequencyofMolecularWeightDetermination	<p><b>Conditionally Required:</b> For gaseous fuels only, the frequency of molecular weight determinations for the specified fuel during the reporting year. See list of allowable values below. If the frequency you are reporting does not appear in the list, then report "Other (specify)" and then specify the frequency in the "OtherFrequencyofMolecularWeightDetermination" data element.</p> <p>Hourly Daily Weekly Monthly Semiannually Quarterly Once per fuel lot Upon addition of oil to the storage tank Other (specify)</p>
OtherFrequencyofMolecularWeightDetermination	<b>Conditionally Required:</b> For gaseous fuels only, the frequency of the molecular weight determinations if "Other (specify)" is reported.

TotalNumberMolecularWeightDeterminations	<b>Conditionally Required:</b> For gaseous fuels only, the number of substitute data values used for molecular weight used in the annual GHG emissions calculations.
NumberValidMolecularWeightDeterminations	<b>Conditionally Required:</b> For gaseous fuels only, the total number of valid molecular weight determinations made during the reporting year for the specified fuel type.
MolarVolumeConstantValue	Conditionally Required: For gaseous fuels only, the value of the molar volume constant value (MVC) at standard conditions used in Equation C-5. The selection is limited to 836.6 or 849.5 Set the units of measure to scf/kg-mole in the attribute <b>massUOM</b> .
NumberofOperatingHoursSubstitutedFuelUsage	For all fuels, the total number of operating hours in the year for which missing data substitution was used for fuel usage. Set the units of measure to "Hours" in the attribute <b>timeUOM</b> .

### XML Excerpt 32 Example for Tier 3 Fuel Details Emissions Details Node

```

<ghg:MolarVolumeConstantValue>836.6</ghg:MolarVolumeConstantValue>
<ghg:FrequencyofCarbonContentDetermination>Weekly</ghg:FrequencyofCarbonContentDetermination>
<ghg:TotalNumberCarbonContentDeterminations>4</ghg:TotalNumberCarbonContentDeterminations>
<ghg:NumberValidCarbonContentDeterminations>48</ghg:NumberValidCarbonContentDeterminations>
<ghg:FrequencyofMolecularWeightDetermination>Weekly</ghg:FrequencyofMolecularWeightDetermination>
<ghg:TotalNumberMolecularWeightDeterminations>22</ghg:TotalNumberMolecularWeightDeterminations>
<ghg:NumberValidMolecularWeightDeterminations>30</ghg:NumberValidMolecularWeightDeterminations>
<ghg:NumberOfOperatingHoursSubstitutedFuelUsage
timeUOM="Hours">50</ghg:NumberOfOperatingHoursSubstitutedFuelUsage>
</ghg:Tier3FuelDetails>
</ghg:TierFuelDetails>

```

**Note:** The code excerpt above is presented here to demonstrate the concept of reporting greenhouse gas emissions data.

➔ See [Section 6.0](#) for instructions on how to report facility level roll-up emissions or see [Section 2.0](#) for instructions on how to report for a different configuration.



## 4.4 Tier 4 Fuel Details

**Figure 53**  
**Tier 4 Fuel Details Schema Diagram**

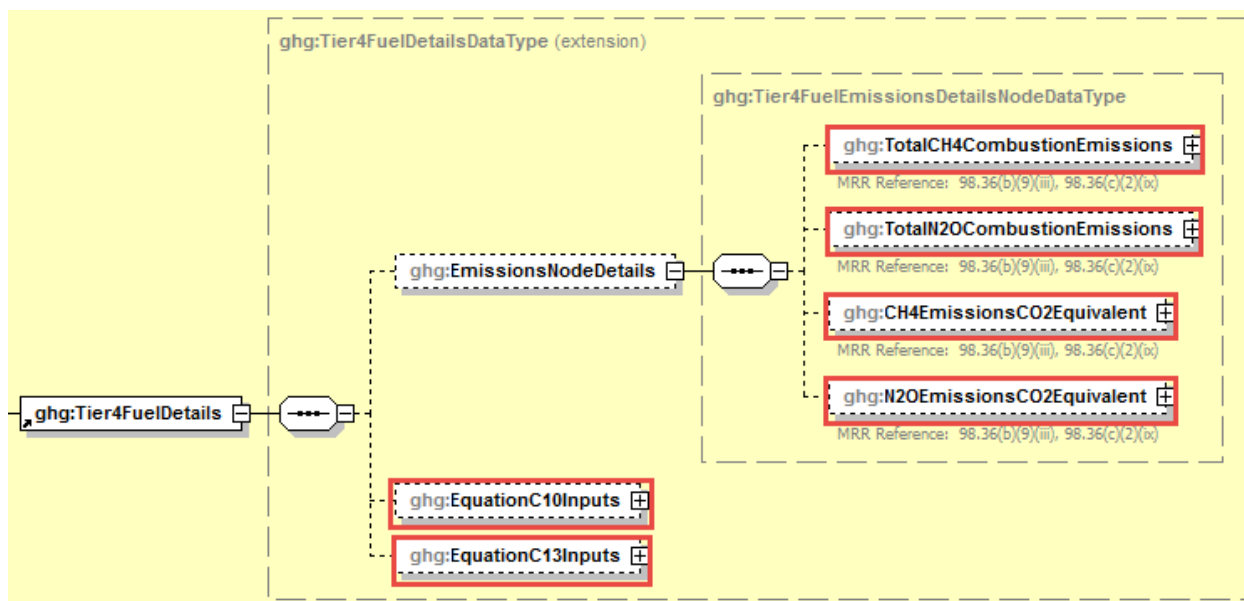

**Note:** Data elements boxed in red are required.

When a **Tier 4 (CEMS)** configuration is used, you are required to report the following information for each fuel type listed in Table C-2 (including biomass fuel(s)):

- The total annual CH<sub>4</sub> mass emissions derived from Equation C-10, in metric tons CH<sub>4</sub> and in metric tons CO<sub>2</sub>e [98.36(b)(9)(iii), 98.36(c)(2)(ix)]
- The total annual N<sub>2</sub>O mass emissions derived from Equation C-10, in metric tons N<sub>2</sub>O and in metric tons CO<sub>2</sub>e [98.36(b)(9)(iii), 98.36(c)(2)(ix)]
- Inputs for Equation C-10
- Inputs for Equation C-13

**Table 40**  
**Tier 4 Fuel Details Data Element Definitions**

Data Element Name	Description
<b>Tier4FuelDetails</b>	<b>Parent Element (Conditionally Required):</b> A collection of data elements containing information for fuels that are combusted in configurations that use Tier 4.
<b>EmissionsNodeDetails</b>	<b>Parent Element:</b> The annual emissions by type of fuel.
TotalCH4CombustionEmissions	The total annual CH <sub>4</sub> mass emissions for the specified fuel combusted in the reporting configuration, calculated using Equation C-10. Report the value in the child data element <b>CalculatedValue</b> . Set the units of measure to “Metric Tons” in the attribute <b>massUOM</b> .
TotalN2OCombustionEmissions	The total annual N <sub>2</sub> O mass emissions for the specified fuel combusted in the reporting configuration, calculated using Equation C-10. Report the value in the child data element <b>CalculatedValue</b> . Set the units of measure to “Metric Tons” in the attribute <b>massUOM</b> .
CH4EmissionsCO2Equivalent	The total annual CH <sub>4</sub> mass emissions for the specified fuel combusted in the reporting configuration. Multiply the calculated value for CH <sub>4</sub> emissions by the Global Warming Potential of 25 for reporting year 2013 and onward or 21 for reporting years 2010-2012 to arrive at the CO <sub>2</sub> e of the CH <sub>4</sub> emissions. Report the value in the child data element <b>CalculatedValue</b> . Set the units of measure to “Metric Tons” in the attribute <b>massUOM</b> .
N2OEmissionsCO2Equivalent	The total annual N <sub>2</sub> O mass emissions for the specified fuel combusted in the reporting configuration. Multiply the calculated value for N <sub>2</sub> O emissions by the Global Warming Potential of 298 for reporting year 2013 and onward or 310 for reporting years 2010-2012 to arrive at the CO <sub>2</sub> e of the N <sub>2</sub> O emissions. Report the value in the child data element <b>CalculatedValue</b> . Set the units of measure to “Metric Tons” in the attribute <b>massUOM</b> .
<b>EquationC10Inputs</b>	<b>Parent Element (Conditionally Required):</b> A collection of data elements containing information for Equation C10 for units that use Tier 4 Calculation Methodology.
<b>EquationC13Inputs</b>	<b>Parent Element (Conditionally Required):</b> A collection of data elements containing information for Equation C13 to calculate the annual volume of CO <sub>2</sub> emitted from each fuel that uses Tier 4 Calculation Methodology

### XML Excerpt 33 Example for Tier 4 Fuel Details

```

<ghg:Tier4FuelDetails>
  <ghg:EmissionsNodeDetails>
    <ghg:TotalCH4CombustionEmissions massUOM="Metric Tons">
      <ghg:CalculatedValue>400.33</ghg:CalculatedValue>
    </ghg:TotalCH4CombustionEmissions>
    <ghg:TotalN2OCombustionEmissions massUOM="Metric Tons">
      <ghg:CalculatedValue>40.111</ghg:CalculatedValue>
    </ghg:TotalN2OCombustionEmissions>
    <ghg:CH4EmissionsCO2Equivalent massUOM="Metric Tons">
      <ghg:CalculatedValue>8400.9</ghg:CalculatedValue>
    </ghg:CH4EmissionsCO2Equivalent>
    <ghg:N2OEmissionsCO2Equivalent massUOM="Metric Tons">
      <ghg:CalculatedValue>12400.5</ghg:CalculatedValue>
    </ghg:N2OEmissionsCO2Equivalent>
  </ghg:EmissionsNodeDetails>
  <ghg:EquationC10Inputs>
    ...See XML Excerpt 34 for details
  </ghg:EquationC10Inputs>
</ghg:Tier4FuelDetails>
</ghg:TierFuelDetails>

```

**Note:** The code excerpt above is presented here to demonstrate the concept of reporting greenhouse gas emissions data.

**Figure 54**  
**Equation C10 Inputs Schema Diagram**

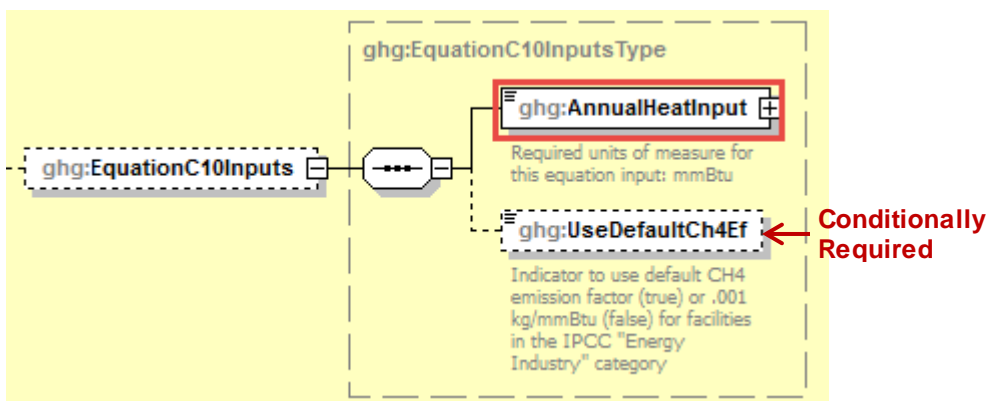

When a Tier 4 (CEMS) configuration is used, report the following inputs for Equation C-10:

- Cumulative annual heat input from combustion of the fuel (mmBtu)
- For facilities in the IPCC “Energy Industry” category that are using coal fuels, whether using the default CH<sub>4</sub> emission factor or .001 kg/mmBtu,

**Table 41**  
**Tier 4 Equation C10 Inputs Data Element Definitions**

Data Element Name	Description
<b>EquationC10Inputs</b>	<b>Parent Element (Conditionally Required):</b> A collection of data elements containing information for Equation C10 for units that use Tier 4 Calculation Methodology.
AnnualHeatInput	Indicate the cumulative annual heat input from combustion of the fuel in mmBtu.
UseDefaultCh4Ef	<b>Conditionally Required:</b> If the facility is in the IPCC “Energy Industry” category and is using coal fuels, indicate “True” if using the default CH <sub>4</sub> emission factor or “False” if using .001 kg/mmBtu.

 See [Section 5.1](#) for instructions on how to report additional Tier 4 details.

**XML Excerpt 34**  
**Example for Equation C10 Inputs**

```

<ghg:Tier4FuelDetails>
  <ghg:EquationC10Inputs>
    <ghg:AnnualHeatInput>5</ghg:AnnualHeatInput>
    <ghg:UseDefaultCh4Ef>TRUE</ghg:UseDefaultCh4Ef>
  </ghg:EquationC10Inputs>
</ghg:Tier4FuelDetails>
</ghg:TierFuelDetails>

```

**Figure 55**  
**Equation C13 Inputs Schema Diagram**

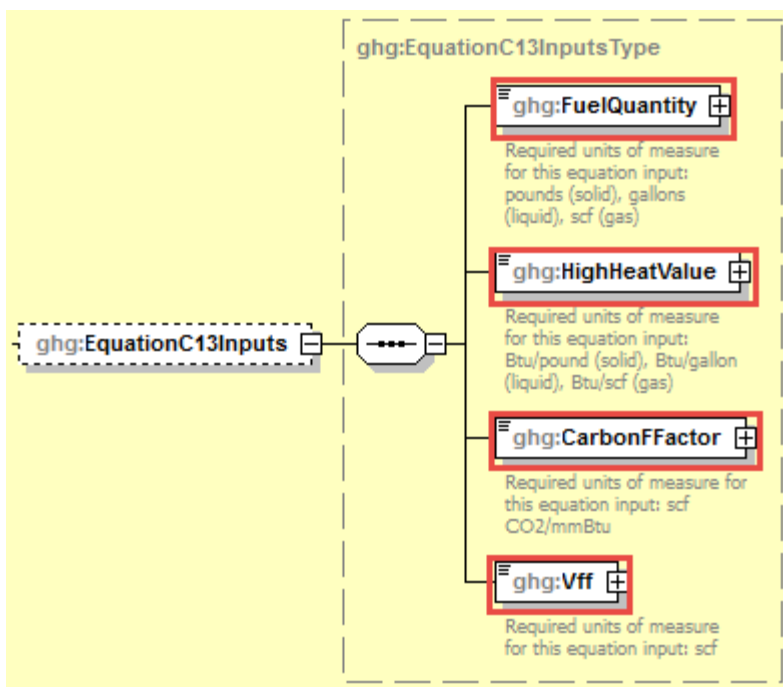

When a Tier 4 (CEMS) configuration is used, report the following inputs for Equation C-13:

- The total quantity of the fossil fuel combusted in the reporting year (from company records) in pounds (solid), gallons (liquid), and scf (gaseous).
- The high heat value of the fossil fuel, from fuel sampling and analysis in Btu/lb (solid), Btu/gal (liquid), or Btu/scf (gaseous).
- Fuel-specific carbon-based F-factor in scfCO<sub>2</sub>/mmBtu.
- The annual volume of CO<sub>2</sub> emitted from fossil fuel combustion

**Table 42**  
**Tier 4 Equation C13 Inputs Data Element Definitions**

Data Element Name	Description
<b>EquationC13Inputs</b>	<b>Parent Element (Conditionally Required):</b> A collection of data elements containing information for Equation C10 for units that use Tier 4 Calculation Methodology.
FuelQuantity	Indicate the total quantity of the fossil fuel combusted in the reporting year, from company records in pounds (solid), gallons (liquid), or scf (gas).
HighHeatValue	Indicate the high heat value of the fossil fuel, from fuel sampling and analysis in Btu/lb (solid), Btu/gallon (liquid) or Btu/scf (gas).

Data Element Name	Description
CarbonFFactor	Indicate the fuel-specific carbon based F-factor in scf CO <sub>2</sub> /mmBtu..
Vff	Specify the annual volume of CO <sub>2</sub> emitted from combustion of a particular fossil fuel in scf.

**XML Excerpt 35**  
**Example for Equation C13 Inputs**

```

<ghg:Tier4FuelDetails>
  <ghg:EquationC13Inputs>
    <ghg:FuelQuantity> </ghg:FuelQuantity>
    <ghg:HighHeatValue> </ghg:HighHeatValue>
    <ghg:CarbonFFactor> </ghg:CarbonFFactor>
    <ghg:Vff> </ghg:Vff>
  </ghg:EquationC13Inputs>
</ghg:Tier4FuelDetails>
</ghg:TierFuelDetails>
    
```

 See [Section 5.1](#) for instructions on how to report additional Tier 4 details.

## 4.5 Part 75 Fuel Details

**Figure 56**  
**Part 75 Fuel Details Schema Diagram**

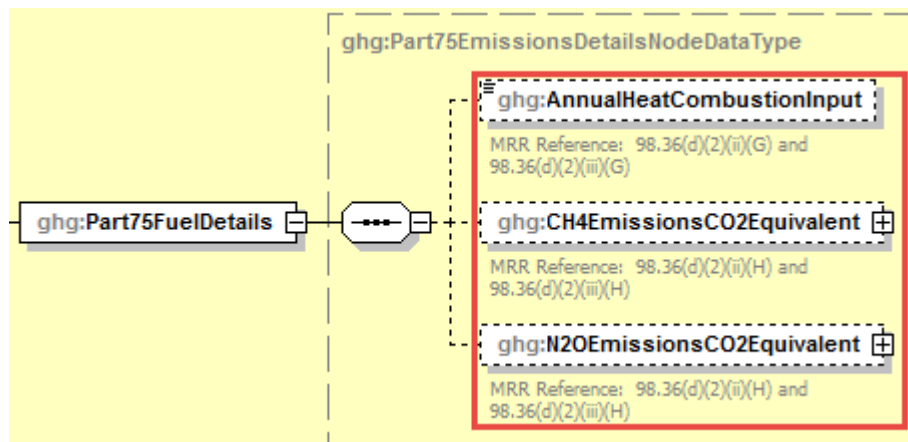

**Note:** Data elements boxed in red are required.

For configurations using the alternative CO<sub>2</sub> mass emissions calculation methods provided in **98.33(a)(5) (Year-round Part 75 heat input reporters)**, Subpart C requires the following information for each fuel type listed in Table C-2 (including biomass fuel(s)) except as otherwise provided in 98.33(c)(4)(ii)(D):

- The total annual heat input from each fuel listed in Table C-2 [98.36(d)(1)(iv), 98.36(d)(2)(ii)(G), 98.36(d)(2)(iii)(G)].
- The total annual CH<sub>4</sub> mass emissions derived from Equation C-10, in metric tons CO<sub>2</sub>e [98.36(d)(1)(iii), 98.36(d)(2)(ii)(H), 98.36(d)(2)(iii)(H)]
- The total annual N<sub>2</sub>O mass emissions derived from Equation C-10, in metric tons CO<sub>2</sub>e [98.36(d)(1)(iii), 98.36(d)(2)(ii)(H), 98.36(d)(2)(iii)(H)]

For each fuel, CH<sub>4</sub> and N<sub>2</sub>O emissions should be reported at the same level (i.e. monitoring location) as CO<sub>2</sub> emissions are reported.

**Table 43**  
**Part 75 Fuel Details Data Element Definitions**

Data Element Name	Description
<b>Part75FuelDetails</b>	<b>Parent Element (Conditionally Required):</b> Collection of data elements pertaining to annual CH <sub>4</sub> and N <sub>2</sub> O emissions from certain Part 75 units that calculate CO <sub>2</sub> emissions according to 98.33(a)(5).
AnnualHeatCombustionInput	<b>Conditionally Required:</b> The total heat input from each fuel listed in Table C-2 of Subpart C combusted during the year in mmBtu. This reporting element is only required for fuels listed in Table C-2. Units that use CEMS and elect to use the provision under 98.33(c)(4)(ii)(B) report this element only for the fuel to which the total heat input was attributed.
CH4EmissionsCO2Equivalent	<b>Parent Element (Conditionally Required):</b> The total annual CH <sub>4</sub> mass emissions for the specified fuel combusted at each monitored location in metric tons CO <sub>2</sub> e, calculated using Equation C-10. Multiply the calculated value for CH <sub>4</sub> emissions by the Global Warming Potential (25 for reporting year 2013 and onward or 21 for reporting years 2010-2012) to arrive at the CO <sub>2</sub> e of the CH <sub>4</sub> emissions. Report the value in the child data element <b>CalculatedValue</b> . Set the units of measure to “Metric Tons” in the attribute <b>massUOM</b> .
N2OEmissionsCO2Equivalent	<b>Parent Element (Conditionally Required):</b> The total annual N <sub>2</sub> O mass emissions for the specified fuel combusted at each monitored location in metric tons CO <sub>2</sub> e, calculated using Equation C-10. Multiply the calculated value for N <sub>2</sub> O emissions by the Global Warming Potential (298 for reporting year 2013 and onward or 310 for reporting years 2010-2012) to arrive at the CO <sub>2</sub> e of the N <sub>2</sub> O emissions. Report the value in the child data element <b>CalculatedValue</b> . Set the units of measure to “Metric Tons” in the attribute <b>massUOM</b> .



### XML Excerpt 36 Example for Part 75 Fuel Details

```
<ghg:Part75FuelDetails>  
  <ghg:CH4EmissionsCO2Equivalent massUOM="Metric Tons">  
    <ghg:CalculatedValue>8400.9</ghg:CalculatedValue>  
  </ghg:CH4EmissionsCO2Equivalent>  
  <ghg:N2OEmissionsCO2Equivalent massUOM="Metric Tons">  
    <ghg:CalculatedValue>12400.5</ghg:CalculatedValue>  
  </ghg:N2OEmissionsCO2Equivalent>  
</ghg:Part75FuelDetails>
```

**Note:** The code excerpt above is presented here to demonstrate the concept of reporting greenhouse gas emissions data.

 See [Section 3.6](#) for instructions on how to report additional Part 75 details.

## 5.0 Additional Configuration Level Emission Reporting

### 5.1 Biogenic CO<sub>2</sub> Verification Data

Subpart C requires the following additional information aggregated at the configuration-level for configuration types 1, 2, 3, 4, and 5. This information is **conditionally required**. Report only if ASTM methods D7495-08 and D6866-08 were used to determine the biogenic portion of the annual CO<sub>2</sub> emissions for a unit.

**Figure 57**  
**Biogenic Portion of CO<sub>2</sub> Emissions and Portion Verification Schema Diagram**

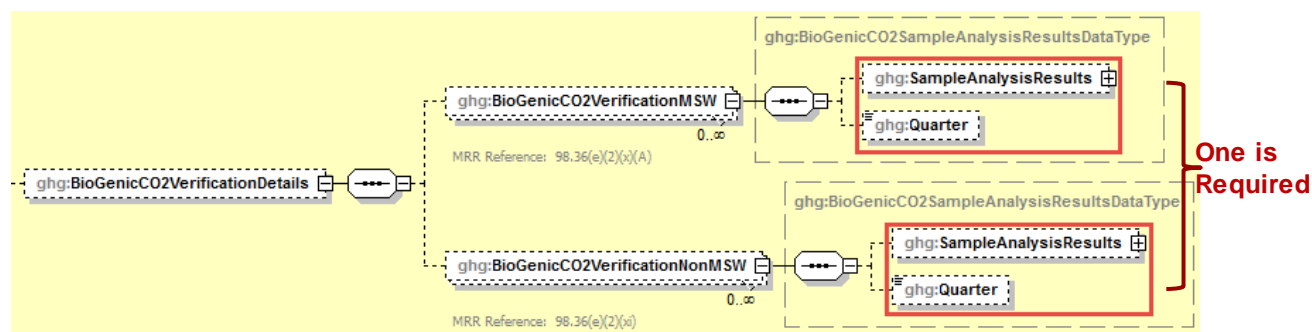

**Note:** Please see page 4 of this document for more information on conditionally required elements

- **Conditionally Required:** If ASTM methods D7495-08 and D6866-08 were used to determine the biogenic portion of the annual CO<sub>2</sub> emissions from MSW combustion as described in 98.34(d), then report the following:
  - The quarterly sample analysis results using data element “BioGenicCO2VerificationMSW”. [98.36(e)(2)(x)(A)]

**Note:** This applies only when MSW is either the primary fuel or the only fuel with a biogenic component combusted.

OR

- **Conditionally Required:** If ASTM methods D7495-08 and D6866-08 were used in accordance with 98.34(e) to determine the biogenic portion of the annual CO<sub>2</sub> emissions from a unit that combusts combinations of biomass fuel(s), or heterogeneous fuels that have a biomass component, e.g., tires, and fossil (or other non-biogenic) fuel(s), then report the following:
  - The quarterly sample analysis results using data element “BioGenicCO2VerificationNonMSW”. [98.36(e)(2)(xi)]

**Table 44**  
**Biogenic CO<sub>2</sub> Verification Details Data Element Definitions**

Data Element Name	Description
BiogenicCO2Verification Details	<b>Parent Element (Conditionally Required):</b> A collection of data elements containing details regarding the quarterly biogenic portion sampling results. Report only if ASTM methods D7495-08 and D6866-08 were used to determine the biogenic portion of the annual CO <sub>2</sub> emissions for a unit.
BioGenicCO2VerificationMSW	<b>Parent Element (Conditionally Required):</b> A collection of data elements containing details regarding the quarterly biogenic portion sampling results if burning MSW.
Sample Analysis Results	The results of each quarterly sample analysis. Report the value in the child data element <b>MeasureValue</b> expressed as a decimal fraction. [98.36(e)(2)(x)(A)]
Quarter	Quarter in which sample was taken (First Quarter, Second Quarter, Third Quarter, Fourth Quarter). [98.36(e)(2)(x)(A)]
BioGenicCO2VerificationNonMSW	<b>Parent Element (Conditionally Required):</b> A collection of data elements containing details regarding the quarterly biogenic portion sampling results if co-firing biogenic fuel(s) (or partly-biogenic fuels, including tires if you are electing to report biogenic CO <sub>2</sub> emissions from tire combustion) and non-biogenic fuel(s).
Sample Analysis Results	The results of each quarterly sample analysis. Report the value in the child data element <b>MeasureValue</b> expressed as a decimal fraction. [98.36(e)(2)(xi)]
Quarter	Quarter in which sample was taken (First Quarter, Second Quarter, Third Quarter, Fourth Quarter). [98.36(e)(2)(xi)]

**XML Excerpt 37**  
**Example for Biogenic Portion of CO<sub>2</sub> Emissions and Portion Verification Data**

```

<ghg:BioGenicCO2MassEmissionsMSW massUOM="Metric Tons">
  <ghg:CalculatedValue>20000</ghg:CalculatedValue>
</ghg:BioGenicCO2MassEmissionsMSW>
<ghg:BioGenicCO2VerificationDetails>
  <ghg:BioGenicCO2VerificationMSW>
    <ghg:SampleAnalysisResults fractionUOM="Decimal Fraction">
      ghg:MeasureValue>0.67</ghg:MeasureValue>
    </ghg:SampleAnalysisResults>
    <ghg:Quarter>First Quarter</ghg:Quarter>
  </ghg:BioGenicCO2VerificationMSW>
</ghg:BioGenicCO2VerificationDetails>

```

**Note:** The code excerpt above is presented here to demonstrate the concept of reporting greenhouse gas emissions data.

 See [Section 4.0](#) for instructions on how to report fuel data for the configuration identified.

## 5.2 Tier 4 Details

For configurations of Type 2 and Type 5, Subpart C requires additional information aggregated at the configuration-level.

**Figure 58**  
**Tier 4 Details Schema Diagram**

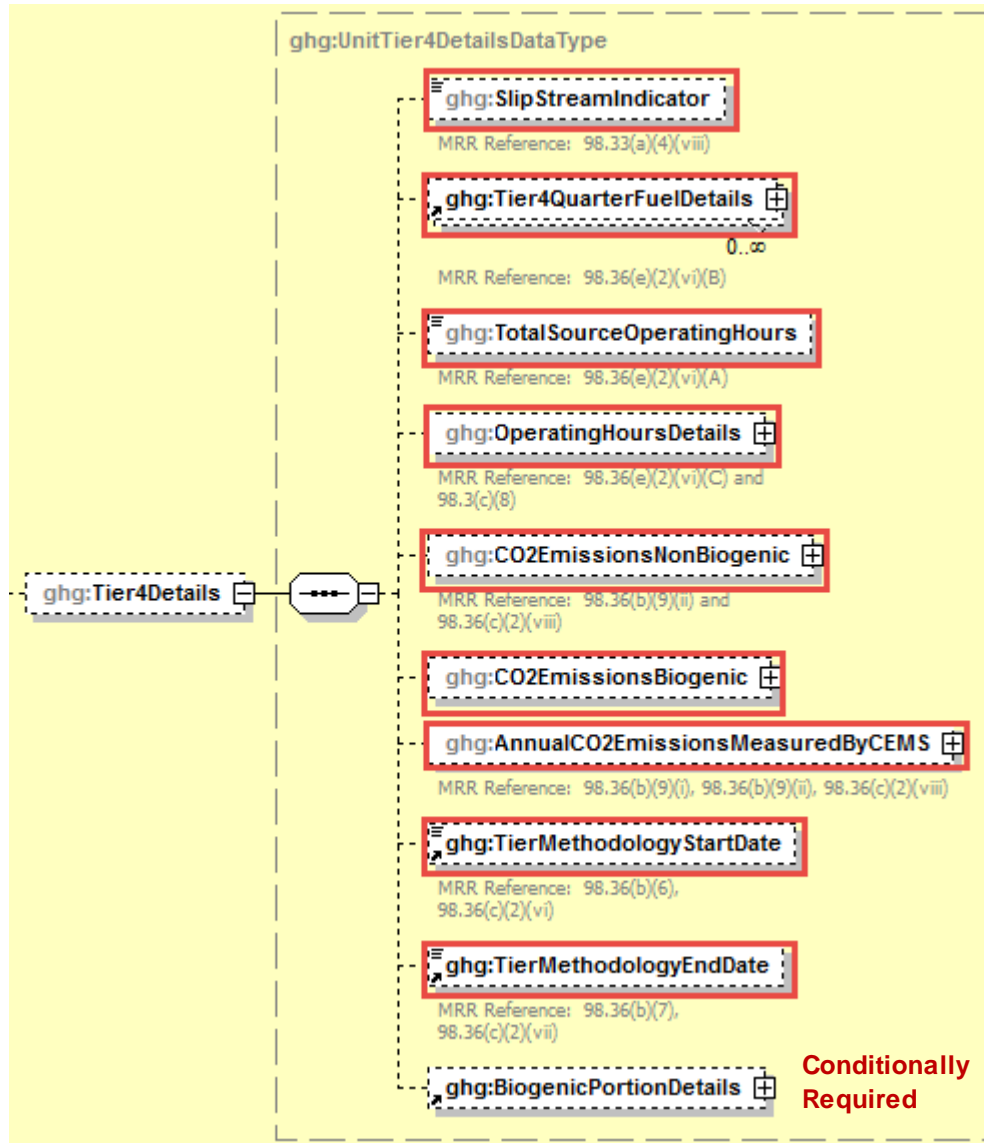

**Note:** Data elements boxed in red are required. Please see page 4 of this document for more information on conditionally required elements.

**Figure 59**  
**Tier 4 Quarter Details Schema Diagram**

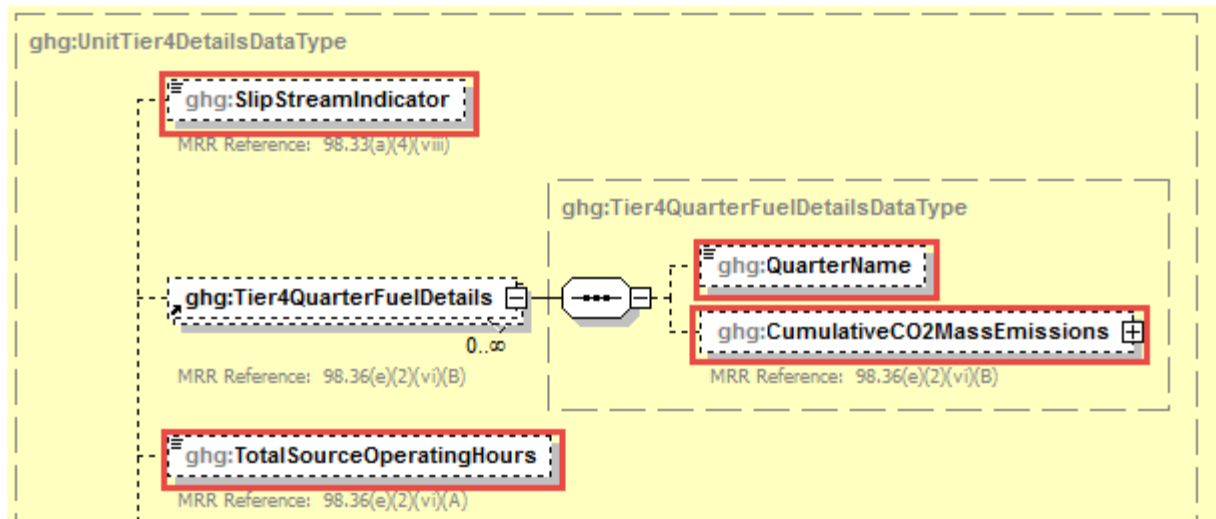

**Note:** Data elements boxed in red are required.

For configurations of Type 2 and Type 5, report the following information:

- Specify if emissions reported for the CEMS include emissions calculated according to 98.33(a)(4)(viii) for a slipstream that bypassed the CEMS [98.33(a)(4)(viii)]
- The cumulative CO<sub>2</sub> mass emissions for each quarter during the reporting year [98.36(e)(2)(vi)(B)]
- The total number of source operating hours in the reporting year [98.36(e)(2)(vi)(A)]

**Table 45**  
**Tier 4 Details Data Element Definitions**

Data Element Name	Description
<b>Tier4Details</b>	<b>Parent Element (Conditionally Required):</b> A collection of data elements containing information regarding units that use Tier 4 only.
SlipStreamIndicator	An indication (Y/N) that the emissions reported for the CEMS include emissions calculated according to 98.33(a)(4)(viii) for a slipstream that bypassed the CEMS.
<b>Tier4QuarterFuelDetails</b>	<b>Parent Element</b>
QuarterName	The name of the quarter. See list of allowable values:  First Quarter Second Quarter Third Quarter Fourth Quarter

Data Element Name	Description
CumulativeCO2MassEmissions	<b>Parent Element:</b> The cumulative CO <sub>2</sub> mass emissions for the specified quarter of the reporting year. The cumulative value is the sum of hourly emissions for the respective quarter only (for example, for the fourth quarter, the emissions will be summed for the fourth quarter only, not from all four quarters in the year). Report the value in the child data element <b>CalculatedValue</b> . Set the units of measure to “Metric Tons” in the attribute <b>massUOM</b> .
TotalSourceOperatingHours	The total number of source operating hours in the reporting year.

### XML Excerpt 38 Example for Tier 4 Details

```

<ghg:Tier4Details >
  <ghg:SlipStreamIndicator>Y</ghg:SlipStreamIndicator >
  <ghg:Tier4QuarterFuelDetails >
    <ghg:QuarterName>First Quarter</ghg:QuarterName >
    <ghg:CumulativeCO2MassEmissions massUOM="Metric Tons" >
      <ghg:CalculatedValue>4100.2</ghg:CalculatedValue >
    </ghg:CumulativeCO2MassEmissions >
  </ghg:Tier4QuarterFuelDetails >
  <ghg:Tier4QuarterFuelDetails >
    <ghg:QuarterName>Second Quarter</ghg:QuarterName >
    <ghg:CumulativeCO2MassEmissions massUOM="Metric Tons" >
      <ghg:CalculatedValue>4200.4</ghg:CalculatedValue >
    </ghg:CumulativeCO2MassEmissions >
  </ghg:Tier4QuarterFuelDetails >
  <ghg:Tier4QuarterFuelDetails >
    <ghg:QuarterName>Third Quarter</ghg:QuarterName >
    <ghg:CumulativeCO2MassEmissions massUOM="Metric Tons" >
      <ghg:CalculatedValue>4300.6</ghg:CalculatedValue >
    </ghg:CumulativeCO2MassEmissions >
  </ghg:Tier4QuarterFuelDetails >
  <ghg:Tier4QuarterFuelDetails >
    <ghg:QuarterName>Fourth Quarter</ghg:QuarterName >
    <ghg:CumulativeCO2MassEmissions massUOM="Metric Tons" >
      <ghg:CalculatedValue>4400.8</ghg:CalculatedValue >
    </ghg:CumulativeCO2MassEmissions >
  </ghg:Tier4QuarterFuelDetails >
  <ghg:TotalSourceOperatingHours >4000</ghg:TotalSourceOperatingHours >

```

**Note:** The code excerpt above is presented here to demonstrate the concept of reporting greenhouse gas emissions data.

**Figure 60**  
**Operating Hours Details Schema Diagram**

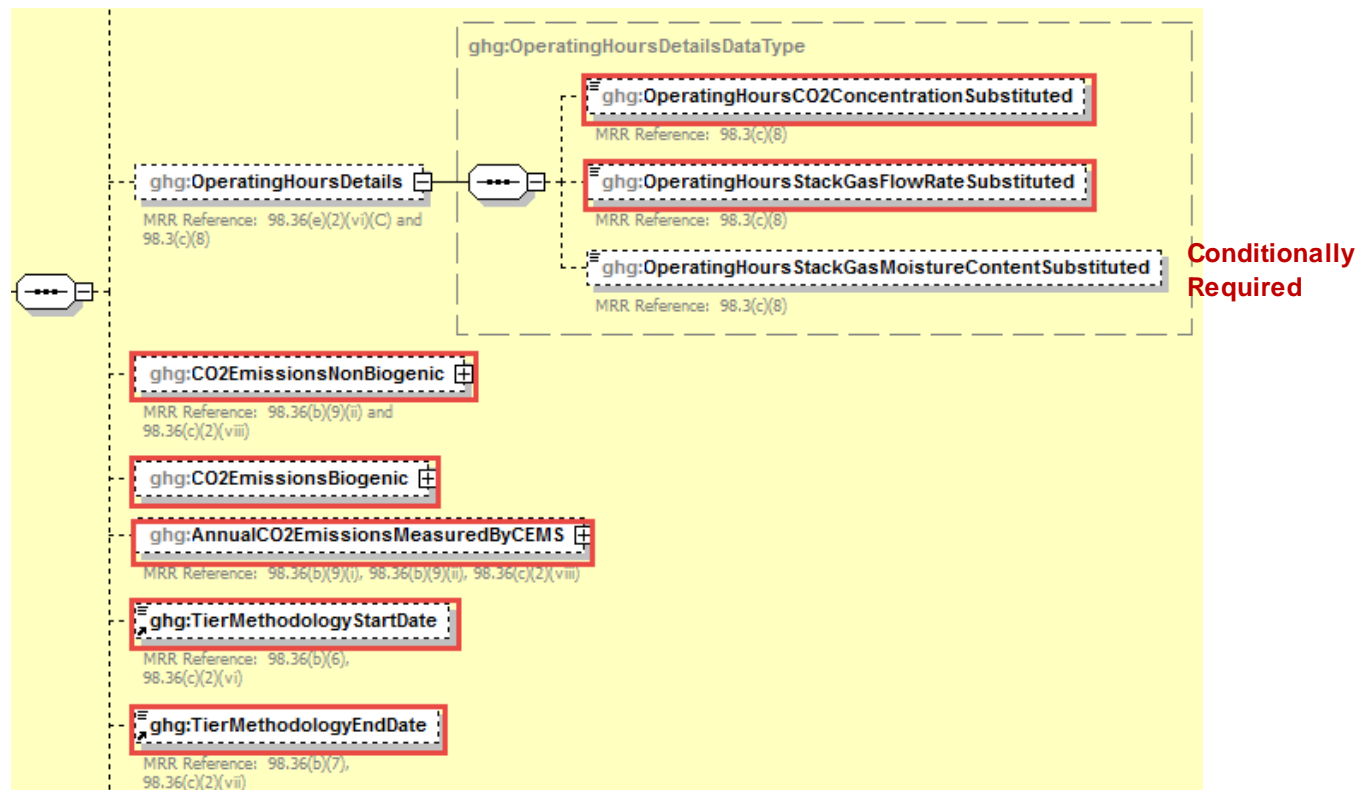

**Note:** Data elements boxed in red are required.

For configurations of Type 2 and Type 5, report the following information:

- The total operating hours in which a substitute data value was used in the emissions calculations for the CO<sub>2</sub> concentration parameter [98.36(e)(2)(vi)(C), 98.3(c)(8)]
- The total operating hours in which a substitute data value was used in the emissions calculations for the stack gas flow rate parameter [98.36(e)(2)(vi)(C), 98.3(c)(8)]
- **Conditionally Required:** The total operating hours in which a substitute data value was used in the emissions calculations for the stack gas moisture content parameter (if moisture correction is required and a continuous moisture monitor is used) [98.36(e)(2)(vi)(C), 98.3(c)(8)]
- The total annual non-biogenic CO<sub>2</sub> mass emissions (i.e. CO<sub>2</sub> mass emissions from fossil fuels, sorbent use and process emissions) [98.36(b)(9)(ii), 98.36(c)(2)(viii)]
- The total annual biogenic CO<sub>2</sub> mass emissions [98.36(b)(9)(ii), 98.36(c)(2)(viii)]
- The total annual CO<sub>2</sub> mass emissions measured by the CEMS (this includes both biogenic and non-biogenic CO<sub>2</sub>) [98.36(b)(9)(i)-(ii), 98.36(c)(2)(viii)]
- The methodology start date and end date for the configuration [98.36(b)(6)-(7), 98.36(c)(2)(vi)-(vii)]

**Table 46**  
**Operating Hours Details Data Element Definitions**

Data Element Name	Description
<b>OperatingHoursDetails</b>	<b>Parent Element:</b> A collection of data elements containing details about the percentage of source operating hours in which a substitute data value was in the emissions calculations.
OperatingHoursCO2ConcentrationSubstituted	The total operating hours in which a substitute data value was used in the emissions calculations for the CO <sub>2</sub> concentration parameter (if an O <sub>2</sub> monitor is used to calculate CO <sub>2</sub> concentration, report missing data for the O <sub>2</sub> monitor here).
OperatingHoursStackGasFlowRateSubstituted	The total operating hours in which a substitute data value was used in the emissions calculations for the stack gas flow rate parameter.
OperatingHoursStackGasMoistureContentSubstituted	<b>Conditionally Required:</b> If moisture correction is required and a continuous moisture monitor is used, the total operating hours in which a substitute data value was used in the emissions calculations for the stack gas moisture content parameter. Otherwise, do not report this element.
CO2EmissionsNonBiogenic	Total annual non-biogenic CO <sub>2</sub> mass emissions (includes fossil fuel, sorbent, process CO <sub>2</sub> emissions and fossil CO <sub>2</sub> from fuels with mixed fossil and biogenic components). Report the value in the child data element <b>CalculatedValue</b> . Set the units of measure to “Metric Tons” in the attribute <b>massUOM</b> .
CO2EmissionsBiogenic	Total annual biogenic CO <sub>2</sub> mass emissions from biomass fuels and the biogenic CO <sub>2</sub> from fuels with mixed fossil and biogenic components (i.e. MSW or tires). Report the value in the child data element <b>CalculatedValue</b> . Set the units of measure to “Metric Tons” in the attribute <b>massUOM</b> .
AnnualCO2EmissionsMeasuredByCEMS	The total annual CO <sub>2</sub> mass emissions measured by the CEMS (this includes both biogenic and non-biogenic CO <sub>2</sub> ). Report the value in the child data element <b>CalculatedValue</b> . Set the units of measure to “Metric Tons” in the attribute <b>massUOM</b> .
TierMethodologyStartDate	The tier methodology start date for the specified reporting configuration (YYYY-MM-DD).
TierMethodologyEndDate	The tier methodology end date for the specified reporting configuration (YYYY-MM-DD).



### XML Excerpt 39 Example for Operating Hours Details

```

<ghg:OperatingHoursDetails>
  <ghg:OperatingHoursCO2ConcentrationSubstituted>400</ghg:OperatingHoursCO2ConcentrationSubstituted>
  <ghg:OperatingHoursStackGasFlowRateSubstituted>40</ghg:OperatingHoursStackGasFlowRateSubstituted>
  <ghg:OperatingHoursStackGasMoistureContentSubstituted>4</ghg:OperatingHoursStackGasMoistureContentSubstituted>
</ghg:OperatingHoursDetails>
<ghg:CO2EmissionsNonBiogenic massUOM="Metric Tons">
  <ghg:CalculatedValue>30000.3</ghg:CalculatedValue>
</ghg:CO2EmissionsNonBiogenic>
<ghg:CO2EmissionsBiogenic massUOM="Metric Tons">
  <ghg:CalculatedValue>400.1</ghg:CalculatedValue>
</ghg:CO2EmissionsBiogenic>
<ghg:AnnualCO2EmissionsMeasuredByCEMS massUOM="Metric Tons">
  <ghg:CalculatedValue>40000.7</ghg:CalculatedValue>
</ghg:AnnualCO2EmissionsMeasuredByCEMS>
<ghg:TierMethodologyStartDate>2011-01-01</ghg:TierMethodologyStartDate>
<ghg:TierMethodologyEndDate>2011-12-31</ghg:TierMethodologyEndDate>

```

**Note:** The code excerpt above is presented here to demonstrate the concept of reporting greenhouse gas emissions data.

**Figure 61  
Biogenic Portion Details Schema Diagram**

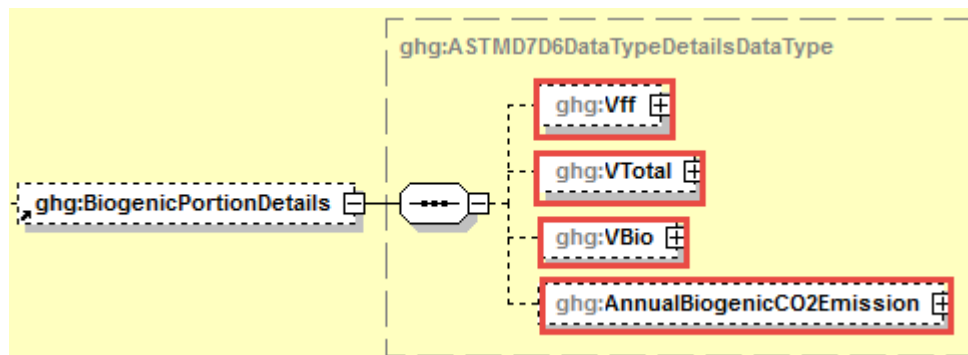

**Note:** Data elements boxed in red are required.

#### *Were biogenic CO<sub>2</sub> emissions estimated using the methodology described by Equations*

#### *C-12, C-13 and C-14?*

If biogenic CO<sub>2</sub> emissions were estimated using the methodology described by Equations C-12, C-13 and C-14 (see section 98.33(e)(2)), then the following additional information is also required by Subpart C for configurations of Type 2 and 5:

- The total annual volume of CO<sub>2</sub> emitted from the combustion of all fossil fuels, V<sub>ff</sub> [98.36(e)(2)(ix)(B)]
- The total annual volume of CO<sub>2</sub> emitted from the combustion of all fuels, V<sub>total</sub> [98.36(e)(2)(ix)(A)]
- The total annual volume of CO<sub>2</sub> emitted from the combustion of all biomass fuels, V<sub>bio</sub> [98.36(e)(2)(ix)(C)]
- The total annual biogenic CO<sub>2</sub> mass emissions calculated using the procedures in 98.33(e)(2) [98.36(e)(2)(ix)(G)]

Please note that the BiogenicPortionDetails parent element is not related to the ASTM biogenic fraction [98.36(e)(2)(x)(A)] reporting requirement.

**Table 47**  
**Biogenic Portion Details Data Element Definitions**

Data Element Name	Description
<b>BiogenicPortionDetails</b>	<b>Parent Element (Conditionally Required):</b> A collection of data elements to report if biogenic CO <sub>2</sub> emissions were estimated using the methodology described by Equations C-12, C-13 and C-14. Otherwise, do not report these elements.
Vff	The annual volume of CO <sub>2</sub> emitted from the combustion of all fossil fuels. (Equation C-13) Report the value in the child data element <b>MeasureValue</b> . Set the units of measure to “scf” in the attribute <b>volUOM</b> .
VTotal	The total annual volume of CO <sub>2</sub> emitted from the combustion of all fuels. Sum of all hourly volume of CO <sub>2</sub> values (VCO <sub>2</sub> h) for the reporting year (Equation C-12). Report the value in the child data element <b>MeasureValue</b> . Set the units of measure to “scf” in the attribute <b>volUOM</b> .
VBio	The annual volume of CO <sub>2</sub> from the combustion of all biomass fuels. Subtract Vff from Vtotal (and any process emissions from a unit that is subject to another Subpart of part 98). Report the value in the child data element <b>MeasureValue</b> . Set the units of measure to “scf” in the attribute <b>volUOM</b> .
AnnualBiogenicCO2Emission	The total annual biogenic CO <sub>2</sub> mass emissions. This value should be the same as reported for the data element CO <sub>2</sub> EmissionsBiogenic. Report the value in the child data element <b>CalculatedValue</b> . Set the units of measure to “Metric Tons” in the attribute <b>massUOM</b> .

### XML Excerpt 40 Example for Biogenic Portion Details

```
<ghg:BiogenicPortionDetails>  
  <ghg:Vff volUOM="scf">  
    <ghg:MeasureValue>4000.1 </ghg:MeasureValue>  
  </ghg:Vff>  
  <ghg:VTot volUOM="scf">  
    <ghg:MeasureValue>4444.2 </ghg:MeasureValue>  
  </ghg:VTot>  
  <ghg:VBio volUOM="scf">  
    <ghg:MeasureValue>444.6 </ghg:MeasureValue>  
  </ghg:VBio>  
  <ghg:AnnualBiogenicCO2Emission massUOM="Metric Tons">  
    <ghg:CalculatedValue>400.9 </ghg:CalculatedValue>  
  </ghg:AnnualBiogenicCO2Emission>  
</ghg:BiogenicPortionDetails>
```

**Note:** The code excerpt above is presented here to demonstrate the concept of reporting greenhouse gas emissions data.

➔ See [Section 6.0](#) for instructions on how to report facility level roll-up emissions or see [Section 2.0](#) for instructions on how to report for a different configuration.

## 6.0 Facility Level Roll-up Emissions

This section provides a description of how to roll up Subpart C emissions totals into the facility’s total CO<sub>2</sub>e emissions, reported under Subpart A.

- Each facility must report the following facility-level emission data:
  - Total CO<sub>2</sub> equivalent (CO<sub>2</sub>e) emissions (excluding biogenic CO<sub>2</sub>) aggregated across all direct emitter source categories (Subparts C-II, SS, and TT) associated with the facility.
  - Total biogenic CO<sub>2</sub> emissions aggregated across all direct emitter source categories (Subparts C-II, SS and TT) associated with the facility.
- Each supplier must report the following supplier data:
  - Total CO<sub>2</sub>e associated with products supplied aggregated across all supplier source categories (Subparts LL-QQ) associated with the facility.

**Figure 62**  
**Facility-Level Roll-up Emissions Schema Diagram**

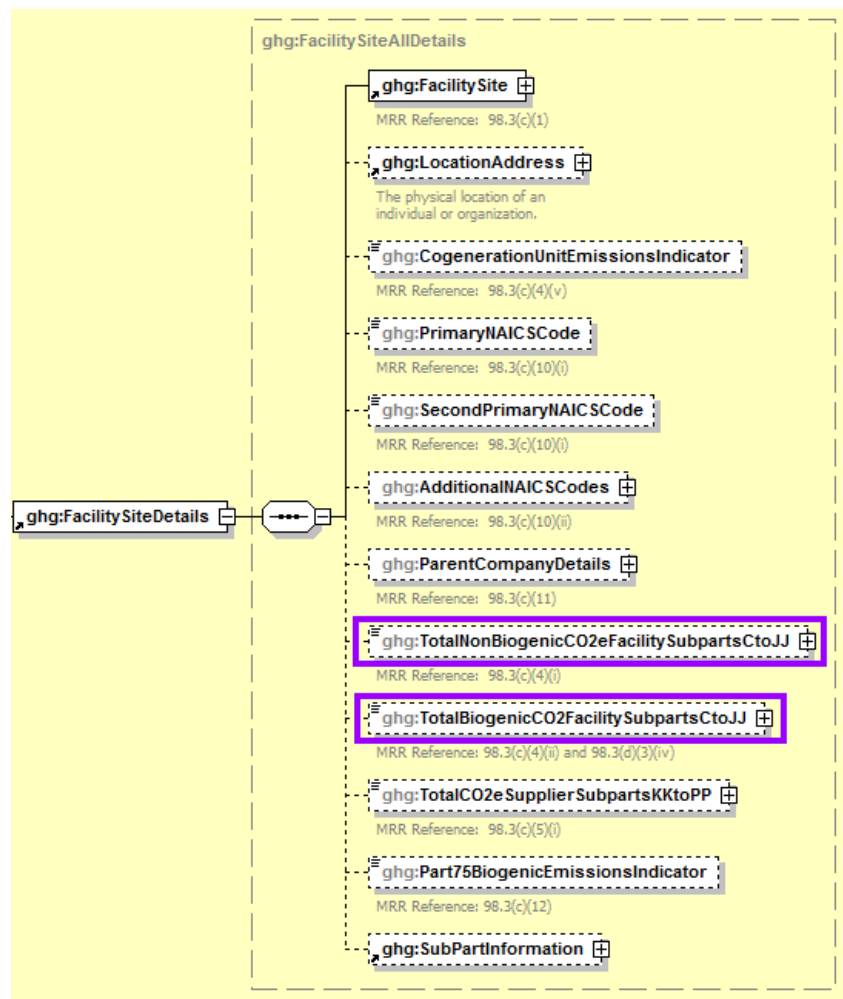

**Note:** Subpart C emissions totals roll up into the data element boxed in purple (Subpart A).

For Subpart C, report total emissions for CO<sub>2</sub>e (excluding biogenic CO<sub>2</sub>) and biogenic CO<sub>2</sub> using the following guidelines.

- 1) Add the total CO<sub>2</sub>e value for Subpart C in metric tons to the total CO<sub>2</sub>e emissions (excluding biogenic CO<sub>2</sub>) aggregated across all direct emitter source categories (Subparts C-II, SS, and TT) associated with the facility as follows:
  - Add the value reported under Subpart C for CO<sub>2</sub> (excluding biogenic CO<sub>2</sub>).
  - Multiply the value reported under Subpart C for CH<sub>4</sub> by the Global Warming Potential for CH<sub>4</sub> (25 for reporting year 2013 and onward or 21 for reporting years 2010-2012) and add the result.
  - Multiply the value reported under Subpart C for N<sub>2</sub>O by the Global Warming Potential for N<sub>2</sub>O (298 for reporting year 2013 and onward or 310 for reporting years 2010-2012) and add the result.
- 2) Add the total annual biogenic CO<sub>2</sub> mass emissions reported under Subpart C to the total biogenic CO<sub>2</sub> aggregated across all direct emitter source categories (Subparts C-II, SS, and TT) associated with the facility.

**Note:** You must follow the rounding rules found in [Table 1](#).

**Table 48**  
**Facility Level Roll-up Emissions Data Element Definitions**

Data Element Name	Description
TotalNonBiogenicCO2eFacilitySubpartsCtoJJ	Add the total CO <sub>2</sub> e value for Subpart C in metric tons to the total CO <sub>2</sub> e emissions (excluding biogenic CO <sub>2</sub> ) aggregated across all direct emitter source categories (Subparts C-II, SS, and TT) associated with the facility according to the guidelines above. Set the units of measure to “Metric Tons” in the attribute <b>massUOM</b> .
TotalBiogenicCO2FacilitySubpartsCtoJJ	Add the total annual biogenic CO <sub>2</sub> mass emissions reported under Subpart C to the total biogenic CO <sub>2</sub> aggregated across all direct emitter source categories (Subparts C-II, SS, and TT) associated with the facility according to the guideline above. Set the units of measure to “Metric Tons” in the attribute <b>massUOM</b> .

**XML Excerpt 41**  
**Example for Facility Level Roll-up Emissions**

```

<ghg:TotalNonBiogenicCO2eFacilitySubpartsCtoJJ massUOM="Metric Tons">727399.9 </ghg:TotalNonBiogenicCO2eFacilitySubpartsCtoJJ>
<ghg:TotalBiogenicCO2FacilitySubpartsCtoJJ massUOM="Metric Tons">14700.2 </ghg:TotalBiogenicCO2FacilitySubpartsCtoJJ>
```

**Note:** The code excerpt above is presented here to demonstrate the concept of reporting greenhouse gas emissions data.

## IV. Appendix A: Sample XML Document for Subpart C

*(Note: Data values do not reflect an actual facility's emissions.)*

```

<GHG xmlns="http://www.ccdsupport.com/schema/ghg">
  <FacilitySiteInformation>
    <CertificationStatement>The designated representative or alternate designated representative must sign (i.e., agree to) this certification statement. If you are an agent and you click on "SUBMIT", you are not agreeing to the certification statement, but are submitting the certification statement on behalf of the designated representative or alternate designated representative who is agreeing to the certification statement. An agent is only authorized to make the electronic submission on behalf of the designated representative, not to sign (i.e., agree to) the certification statement.</CertificationStatement>
    <ReportingYear>2017</ReportingYear>
    <FacilitySiteDetails>
      <FacilitySite>
        <FacilitySiteIdentifier>557863</FacilitySiteIdentifier>
        <FacilitySiteName>Violet Test</FacilitySiteName>
      </FacilitySite>
      <LocationAddress>
        <LocationAddressText>124 N St</LocationAddressText>
        <LocalityName>Arlington</LocalityName>
        <StateIdentity>
          <StateCode>VA</StateCode>
        </StateIdentity>
        <AddressPostalCode>22207</AddressPostalCode>
      </LocationAddress>
      <CogenerationUnitEmissionsIndicator>N</CogenerationUnitEmissionsIndicator>
      <PrimaryNAICSCode>211111</PrimaryNAICSCode>
      <ParentCompanyDetails>
        <ParentCompany>
          <ParentCompanyLegalName>VIOLET</ParentCompanyLegalName>
          <StreetAddress>124 n st</StreetAddress>
          <City>arlington</City>
          <State>VA</State>
          <Zip>22207</Zip>
          <PercentOwnershipInterest>100</PercentOwnershipInterest>
        </ParentCompany>
      </ParentCompanyDetails>
      <TotalNonBiogenicCO2eFacilitySubpartsCtoJJ massUOM="Metric Tons">2.3</TotalNonBiogenicCO2eFacilitySubpartsCtoJJ>
      <TotalBiogenicCO2FacilitySubpartsCtoJJ massUOM="Metric Tons">1200</TotalBiogenicCO2FacilitySubpartsCtoJJ>
      <TotalCO2eSupplierSubpartsKKtoPP massUOM="Metric Tons">0</TotalCO2eSupplierSubpartsKKtoPP>
      <PlantCodeIndicator>N</PlantCodeIndicator>
      <SubPartInformation>
        <SubPartC>
          <GHGasInfoDetails>
            <GHGasName>Biogenic Carbon dioxide</GHGasName>
            <GHGasQuantity massUOM="Metric Tons">
              <CalculatedValue>1200</CalculatedValue>
            </GHGasQuantity>
          </GHGasInfoDetails>
          <GHGasInfoDetails>
            <GHGasName>Methane</GHGasName>
            <GHGasQuantity massUOM="Metric Tons">
              <CalculatedValue>0.02</CalculatedValue>
            </GHGasQuantity>
          </GHGasInfoDetails>
          <GHGasInfoDetails>
            <GHGasName>Nitrous Oxide</GHGasName>
            <GHGasQuantity massUOM="Metric Tons">
              <CalculatedValue>0.006</CalculatedValue>
            </GHGasQuantity>
          </GHGasInfoDetails>
          <GHGasInfoDetails>
            <GHGasName>Nitrous Oxide</GHGasName>
            <GHGasQuantity massUOM="Metric Tons">
              <CalculatedValue>0.006</CalculatedValue>
            </GHGasQuantity>
          </GHGasInfoDetails>
          <GHGasInfoDetails>
            <GHGasName>Nitrous Oxide</GHGasName>
            <GHGasQuantity massUOM="Metric Tons">
              <CalculatedValue>0.006</CalculatedValue>
            </GHGasQuantity>
          </GHGasInfoDetails>
          <GHGasInfoDetails>
            <GHGasName>Nitrous Oxide</GHGasName>
            <GHGasQuantity massUOM="Metric Tons">
              <CalculatedValue>0.006</CalculatedValue>
            </GHGasQuantity>
          </GHGasInfoDetails>
        </SubPartC>
      </SubPartInformation>
    </FacilitySiteDetails>
  </FacilitySiteInformation>
</GHG>

```

```

    <GHGasName>Carbon Dioxide</GHGasName>
    <GHGasQuantity massUOM="Metric Tons">
      <CalculatedValue>0</CalculatedValue>
    </GHGasQuantity>
  </GHGasInfoDetails>
  <UnitsCDetails>
    <UnitIdentification>
      <UnitName>GP- Violet 1</UnitName>
      <UnitType>OCS (Other combustion source)</UnitType>
    </UnitIdentification>
    <SmallUnitAggregationDetails>
      <UseIvtIndicator>Y</UseIvtIndicator>
      <HighestMaxRatedheatInputCapacity heatUOM="mmBtu/hr">
        <MeasureValue>200</MeasureValue>
      </HighestMaxRatedheatInputCapacity>
    </SmallUnitAggregationDetails>
    <CO2EmissionsGeneratedUsingSorbentInjectionDetails>
      <TotalAmountOfSorbentUsed massUOM="Short Tons">4</TotalAmountOfSorbentUsed>
      <SorbentMolecularWeight>0.35</SorbentMolecularWeight>
      <SorbentRatio>0.2</SorbentRatio>
    </CO2EmissionsGeneratedUsingSorbentInjectionDetails>
    <PlantCode>881111, 881112</PlantCode>
    <SorbentCO2EmissionsQuantity massUOM="Metric Tons">
      <CalculatedValue>91.5</CalculatedValue>
      <OverrideIndicator>N</OverrideIndicator>
    </SorbentCO2EmissionsQuantity>
    <CO2EmissionsAllBiomassFuelsCombined massUOM="Metric Tons">
      <CalculatedValue>1000</CalculatedValue>
    </CO2EmissionsAllBiomassFuelsCombined>
    <CO2EmissionsAllFossilFuelsCombined massUOM="Metric Tons">
      <CalculatedValue>1000</CalculatedValue>
    </CO2EmissionsAllFossilFuelsCombined>
    <TierFuelDetails>
      <FuelInputsId>215061</FuelInputsId>
      <FuelType>Distillate Fuel Oil No. 1</FuelType>
      <Tier3FuelDetails>
        <TierName>Tier 3 (Equation C-4, liquid fuel)</TierName>
        <TierMethodologyStartDate>2014-01-01</TierMethodologyStartDate>
        <TierMethodologyEndDate>2014-12-31</TierMethodologyEndDate>
        <EmissionsDetailsNode>
          <TotalCO2CombustionEmissions massUOM="Metric Tons">
            <CalculatedValue>0.7</CalculatedValue>
          </TotalCO2CombustionEmissions>
          <TotalCH4CombustionEmissions massUOM="Metric Tons">
            <CalculatedValue>0.01</CalculatedValue>
          </TotalCH4CombustionEmissions>
          <TotalN2OCombustionEmissions massUOM="Metric Tons">
            <CalculatedValue>0.003</CalculatedValue>
          </TotalN2OCombustionEmissions>
          <CH4EmissionsCO2Equivalent massUOM="Metric Tons">
            <CalculatedValue>0.4</CalculatedValue>
          </CH4EmissionsCO2Equivalent>
          <N2OEmissionsCO2Equivalent massUOM="Metric Tons">
            <CalculatedValue>0.9</CalculatedValue>
          </N2OEmissionsCO2Equivalent>
        </EmissionsDetailsNode>
      </Tier3FuelDetails>
    </TierFuelDetails>
  </UnitsCDetails>
  <FrequencyofCarbonContentDetermination>Monthly</FrequencyofCarbonContentDetermination>
  <TotalNumberCarbonContentDeterminations>100</TotalNumberCarbonContentDeterminations>
  <NumberValidCarbonContentDeterminations>100</NumberValidCarbonContentDeterminations>
  <NumberOfOperatingHoursSubstitutedFuelUsage
timeUOM="Hours">100</NumberOfOperatingHoursSubstitutedFuelUsage>
  </Tier3FuelDetails>
</TierFuelDetails>
</TierFuelDetails>

```

```

<FuelInputsId>215062</FuelInputsId>
<FuelType>Distillate Fuel Oil No. 2</FuelType>
<Tier3FuelDetails>
  <TierName>Tier 3 (Equation C-4, liquid fuel)</TierName>
  <TierMethodologyStartDate>2014-01-01</TierMethodologyStartDate>
  <TierMethodologyEndDate>2014-12-31</TierMethodologyEndDate>
  <EmissionsDetailsNode>
    <TotalCO2CombustionEmissions massUOM="Metric Tons">
      <CalculatedValue>0.7</CalculatedValue>
    </TotalCO2CombustionEmissions>
    <TotalCH4CombustionEmissions massUOM="Metric Tons">
      <CalculatedValue>0.01</CalculatedValue>
    </TotalCH4CombustionEmissions>
    <TotalN2OCombustionEmissions massUOM="Metric Tons">
      <CalculatedValue>0.003</CalculatedValue>
    </TotalN2OCombustionEmissions>
    <CH4EmissionsCO2Equivalent massUOM="Metric Tons">
      <CalculatedValue>0.4</CalculatedValue>
    </CH4EmissionsCO2Equivalent>
    <N2OEmissionsCO2Equivalent massUOM="Metric Tons">
      <CalculatedValue>0.9</CalculatedValue>
    </N2OEmissionsCO2Equivalent>
  </EmissionsDetailsNode>

  <FrequencyofCarbonContentDetermination>Monthly</FrequencyofCarbonContentDetermination>

  <TotalNumberCarbonContentDeterminations>100</TotalNumberCarbonContentDeterminations>

  <NumberValidCarbonContentDeterminations>100</NumberValidCarbonContentDeterminations>
  <NumberOfOperatingHoursSubstitutedFuelUsage
timeUOM="Hours">100</NumberOfOperatingHoursSubstitutedFuelUsage>
  </Tier3FuelDetails>
</TierFuelDetails>
<BioGenicCO2VerificationDetails>
  <BioGenicCO2VerificationMSW>
    <SampleAnalysisResults fractionUOM="decimal fraction">
      <MeasureValue>0.2</MeasureValue>
    </SampleAnalysisResults>
    <Quarter>First Quarter</Quarter>
  </BioGenicCO2VerificationMSW>
  <BioGenicCO2VerificationMSW>
    <SampleAnalysisResults fractionUOM="decimal fraction">
      <MeasureValue>0.2</MeasureValue>
    </SampleAnalysisResults>
    <Quarter>Second Quarter</Quarter>
  </BioGenicCO2VerificationMSW>
  <BioGenicCO2VerificationMSW>
    <SampleAnalysisResults fractionUOM="decimal fraction">
      <MeasureValue>0.2</MeasureValue>
    </SampleAnalysisResults>
    <Quarter>Third Quarter</Quarter>
  </BioGenicCO2VerificationMSW>
  <BioGenicCO2VerificationMSW>
    <SampleAnalysisResults fractionUOM="decimal fraction">
      <MeasureValue>0.2</MeasureValue>
    </SampleAnalysisResults>
    <Quarter>Fourth Quarter</Quarter>
  </BioGenicCO2VerificationMSW>
</BioGenicCO2VerificationDetails>
</UnitsCDetails>
<UnitsCDetails>
  <UnitIdentification>
    <UnitName>Violet Test 2</UnitName>
    <UnitType>S (Stoker Boiler)</UnitType>
  </UnitIdentification>
  <IndividualUnitDetails>
    <UseIvtIndicator>Y</UseIvtIndicator>
  </IndividualUnitDetails>

```



```

    <MaxRatedheatInputCapacity heatUOM="mmBtu/hr">
      <MeasureValue>200</MeasureValue>
    </MaxRatedheatInputCapacity>
  </IndividualUnitDetails>
  <CO2EmissionsGeneratedUsingSorbentInjectionDetails>
    <TotalAmountOfSorbentUsed massUOM="Short
Tons">0.2</TotalAmountOfSorbentUsed>
    <SorbentMolecularWeight>0.2</SorbentMolecularWeight>
    <SorbentRatio>0.2</SorbentRatio>
  </CO2EmissionsGeneratedUsingSorbentInjectionDetails>
  <SorbentCO2EmissionsQuantity massUOM="Metric Tons">
    <CalculatedValue>8.0</CalculatedValue>
    <OverrideIndicator>N</OverrideIndicator>
  </SorbentCO2EmissionsQuantity>
  <CO2EmissionsAllBiomassFuelsCombined massUOM="Metric Tons">
    <CalculatedValue>100</CalculatedValue>
  </CO2EmissionsAllBiomassFuelsCombined>
  <TierFuelDetails>
    <FuelInputsId>215089</FuelInputsId>
    <FuelType>Natural Gas (Weighted U.S. Average)</FuelType>
  <Tier1FuelDetails>
    <TierName>Tier 1 (Equation C-1)</TierName>
    <TierMethodologyStartDate>2014-01-01</TierMethodologyStartDate>
    <TierMethodologyEndDate>2014-12-31</TierMethodologyEndDate>
    <EmissionsDetailsNode>
      <TotalCO2CombustionEmissions massUOM="Metric Tons">
        <CalculatedValue>0.0</CalculatedValue>
      </TotalCO2CombustionEmissions>
      <TotalCH4CombustionEmissions massUOM="Metric Tons">
        <CalculatedValue>0.00</CalculatedValue>
      </TotalCH4CombustionEmissions>
      <TotalN2OCombustionEmissions massUOM="Metric Tons">
        <CalculatedValue>0.000</CalculatedValue>
      </TotalN2OCombustionEmissions>
      <CH4EmissionsCO2Equivalent massUOM="Metric Tons">
        <CalculatedValue>0</CalculatedValue>
      </CH4EmissionsCO2Equivalent>
      <N2OEmissionsCO2Equivalent massUOM="Metric Tons">
        <CalculatedValue>0</CalculatedValue>
      </N2OEmissionsCO2Equivalent>
    </EmissionsDetailsNode>
  </Tier1FuelDetails>
</TierFuelDetails>
<BioGenicCO2VerificationDetails>
  <BioGenicCO2VerificationMSW>
    <SampleAnalysisResults fractionUOM="decimal fraction">
      <MeasureValue>0.3</MeasureValue>
    </SampleAnalysisResults>
    <Quarter>First Quarter</Quarter>
  </BioGenicCO2VerificationMSW>
  <BioGenicCO2VerificationMSW>
    <SampleAnalysisResults fractionUOM="decimal fraction">
      <MeasureValue>0.3</MeasureValue>
    </SampleAnalysisResults>
    <Quarter>Second Quarter</Quarter>
  </BioGenicCO2VerificationMSW>
  <BioGenicCO2VerificationMSW>
    <SampleAnalysisResults fractionUOM="decimal fraction">
      <MeasureValue>0.3</MeasureValue>
    </SampleAnalysisResults>
    <Quarter>Third Quarter</Quarter>
  </BioGenicCO2VerificationMSW>
  <BioGenicCO2VerificationMSW>
    <SampleAnalysisResults fractionUOM="decimal fraction">
      <MeasureValue>0.3</MeasureValue>
    </SampleAnalysisResults>
    <Quarter>Fourth Quarter</Quarter>
  </BioGenicCO2VerificationMSW>

```

```

    </BioGenicCO2VerificationMSW>
  </BioGenicCO2VerificationDetails>
</UnitsCDetails>
<UnitsCDetails>
  <UnitIdentification>
    <UnitName>Violet Test 3</UnitName>
    <UnitType>S (Stoker Boiler)</UnitType>
  </UnitIdentification>
  <IndividualUnitDetails>
    <UseIvtIndicator>Y</UseIvtIndicator>
    <MaxRatedheatInputCapacity heatUOM="mmBtu/hr">
      <MeasureValue>120</MeasureValue>
    </MaxRatedheatInputCapacity>
  </IndividualUnitDetails>
  <CO2EmissionsGeneratedUsingSorbentInjectionDetails>
    <TotalAmountOfSorbentUsed massUOM="Short
Tons">0.3</TotalAmountOfSorbentUsed>
    <SorbentMolecularWeight>0.3</SorbentMolecularWeight>
    <SorbentRatio>0.3</SorbentRatio>
  </CO2EmissionsGeneratedUsingSorbentInjectionDetails>
  <SorbentCO2EmissionsQuantity massUOM="Metric Tons">
    <CalculatedValue>12.0</CalculatedValue>
    <OverrideIndicator>N</OverrideIndicator>
  </SorbentCO2EmissionsQuantity>
  <CO2EmissionsAllBiomassFuelsCombined massUOM="Metric Tons">
    <CalculatedValue>100</CalculatedValue>
  </CO2EmissionsAllBiomassFuelsCombined>
  <TierFuelDetails>
    <FuelInputsId>215109</FuelInputsId>
    <FuelType>Distillate Fuel Oil No. 2</FuelType>
    <Tier2FuelDetails>
      <TierName>Tier 2 (Equation C-2a)</TierName>
      <TierMethodologyStartDate>2014-01-01</TierMethodologyStartDate>
      <TierMethodologyEndDate>2014-12-31</TierMethodologyEndDate>
      <Tier2MonthlyHHVDetails>
        <MonthName>January</MonthName>
        <HighHeatValue>
          <IsSubstitutedIndicator>Y</IsSubstitutedIndicator>
        </HighHeatValue>
      </Tier2MonthlyHHVDetails>
      <Tier2MonthlyHHVDetails>
        <MonthName>February</MonthName>
        <HighHeatValue>
          <IsSubstitutedIndicator>N</IsSubstitutedIndicator>
        </HighHeatValue>
      </Tier2MonthlyHHVDetails>
      <Tier2MonthlyHHVDetails>
        <MonthName>March</MonthName>
        <HighHeatValue>
          <IsSubstitutedIndicator>N</IsSubstitutedIndicator>
        </HighHeatValue>
      </Tier2MonthlyHHVDetails>
      <Tier2MonthlyHHVDetails>
        <MonthName>April</MonthName>
        <HighHeatValue>
          <IsSubstitutedIndicator>Y</IsSubstitutedIndicator>
        </HighHeatValue>
      </Tier2MonthlyHHVDetails>
      <Tier2MonthlyHHVDetails>
        <MonthName>May</MonthName>
        <HighHeatValue>
          <IsSubstitutedIndicator>Y</IsSubstitutedIndicator>
        </HighHeatValue>
      </Tier2MonthlyHHVDetails>
      <Tier2MonthlyHHVDetails>
        <MonthName>June</MonthName>
        <HighHeatValue>

```

```

        <IsSubstitutedIndicator>N</IsSubstitutedIndicator>
      </HighHeat Value>
    </Tier2MonthlyHHVDetails>
  <Tier2MonthlyHHVDetails>
    <MonthName>July</MonthName>
    <HighHeat Value>
      <IsSubstitutedIndicator>N</IsSubstitutedIndicator>
    </HighHeat Value>
  </Tier2MonthlyHHVDetails>
  <Tier2MonthlyHHVDetails>
    <MonthName>August</MonthName>
    <HighHeat Value>
      <IsSubstitutedIndicator>Y</IsSubstitutedIndicator>
    </HighHeat Value>
  </Tier2MonthlyHHVDetails>
  <Tier2MonthlyHHVDetails>
    <MonthName>September</MonthName>
    <HighHeat Value>
      <IsSubstitutedIndicator>Y</IsSubstitutedIndicator>
    </HighHeat Value>
  </Tier2MonthlyHHVDetails>
  <Tier2MonthlyHHVDetails>
    <MonthName>October</MonthName>
    <HighHeat Value>
      <IsSubstitutedIndicator>N</IsSubstitutedIndicator>
    </HighHeat Value>
  </Tier2MonthlyHHVDetails>
  <Tier2MonthlyHHVDetails>
    <MonthName>November</MonthName>
    <HighHeat Value>
      <IsSubstitutedIndicator>N</IsSubstitutedIndicator>
    </HighHeat Value>
  </Tier2MonthlyHHVDetails>
  <Tier2MonthlyHHVDetails>
    <MonthName>December</MonthName>
    <HighHeat Value>
      <IsSubstitutedIndicator>N</IsSubstitutedIndicator>
    </HighHeat Value>
  </Tier2MonthlyHHVDetails>
</Frequency of High Heat Value Determination Monthly </Frequency of High Heat Value Determination>
<EmissionsDetailsNode>
  <TotalCO2CombustionEmissions massUOM="Metric Tons">
    <CalculatedValue>0.0</CalculatedValue>
  </TotalCO2CombustionEmissions>
  <TotalCH4CombustionEmissions massUOM="Metric Tons">
    <CalculatedValue>0.00</CalculatedValue>
  </TotalCH4CombustionEmissions>
  <TotalN2OCombustionEmissions massUOM="Metric Tons">
    <CalculatedValue>0.000</CalculatedValue>
  </TotalN2OCombustionEmissions>
  <CH4EmissionsCO2Equivalent massUOM="Metric Tons">
    <CalculatedValue>0</CalculatedValue>
  </CH4EmissionsCO2Equivalent>
  <N2OEmissionsCO2Equivalent massUOM="Metric Tons">
    <CalculatedValue>0</CalculatedValue>
  </N2OEmissionsCO2Equivalent>
</EmissionsDetailsNode>
</Tier2FuelDetails>
</TierFuelDetails>
<BioGenicCO2VerificationDetails>
  <BioGenicCO2VerificationMSW>
    <SampleAnalysisResults fractionUOM="decimal fraction">
      <MeasureValue>0.2</MeasureValue>
    </SampleAnalysisResults>
    <Quarter>First Quarter</Quarter>
  </BioGenicCO2VerificationMSW>
</BioGenicCO2VerificationMSW>

```

```
<SampleAnalysisResults fractionUOM="decimal fraction">
  <MeasureValue>0.2</MeasureValue>
</SampleAnalysisResults>
<Quarter>Second Quarter</Quarter>
</BioGenicCO2VerificationMSW>
<BioGenicCO2VerificationMSW>
  <SampleAnalysisResults fractionUOM="decimal fraction">
    <MeasureValue>0.2</MeasureValue>
  </SampleAnalysisResults>
  <Quarter>Third Quarter</Quarter>
</BioGenicCO2VerificationMSW>
<BioGenicCO2VerificationMSW>
  <SampleAnalysisResults fractionUOM="decimal fraction">
    <MeasureValue>0.2</MeasureValue>
  </SampleAnalysisResults>
  <Quarter>Fourth Quarter</Quarter>
</BioGenicCO2VerificationMSW>
</BioGenicCO2VerificationDetails>
</UnitsCDetails>
</SubPartC>
</SubPartInformation>
</Facility SiteDetails>
<StartDate>2014-01-01</StartDate>
<EndDate>2014-12-31</EndDate>
<DateTimeReportGenerated>2015-03-06T 16:32:27</DateTimeReportGenerated>
<SubpartBAMMDetails>
  <SubpartName>AR4</SubpartName>
  <WasBAMMUsed>N</WasBAMMUsed>
</SubpartBAMMDetails>
</Facility SiteInformation>
</GHG>
```