

Greenhouse Gas Reporting Program

XML Reporting Instructions For Subpart X – Petrochemical Production

United States Environmental Protection Agency
Climate Change Division
Washington, DC

December 1, 2021

These instructions explain how to report the required data for the applicable regulations. Owners and operators of units should refer to the applicable regulations for information about what data are required to be reported.

[This page intentionally left blank]

Table of Contents

	<u>Page</u>
I. Introduction	1
II. Summary of Changes	8
III. Subpart X Overview.....	9
1.0 Subpart X Total Emissions	12
2.0 CEMS Methodology Details	14
3.0 Mass Balance Methodology Details	27
4.0 Ethylene Combustion Methodology Details	45
5.0 Flare Gas Details	49
6.0 Facility-Level Roll-up Emissions.....	69
IV. Appendix A - Sample XML Document for Subpart X.....	71

List of Tables

		<u>Page</u>
Table 1	Reporting Numbers	2
Table 2	Calculated Details Data Element Definitions	5
Table 3	Measurement Details Data Element Definitions	6
Table 4	Unit Identification Details Data Element Definitions	6
Table 5	Greenhouse Gas Information Details Data Element Definitions	13
Table 6	CEMS Unit Details Data Element Definitions	15
Table 7	Tier 4 CEMS Monitoring Location and Emissions Data Element Definitions	20
Table 8	Tier 4 CEMS Quarterly and Operating Hours Details Data Element Definitions	23
Table 9	Tier 4 CEMS Process Units Details Data Element Definitions	26
Table 10	Unit Identification, Emissions, and Product Definitions Data Element Definitions	29
Table 11	Product and Feedstock Details Data Element Definitions	33
Table 12	Product and Feedstock Monthly Details Data Element Definitions	38
Table 13	Additional Details Data Element Definitions	43
Table 14	Ethylene Combustion Methodology Data Element Definitions	46
Table 15	Flare Gas Unit Details Data Element Definitions	50
Table 16	Flare Gas Unit Emissions and Carbon Fraction Basis Data Element Definitions	53
Table 17	Equation Y-1a Details Data Element Definitions	56
Table 18	Equation Y-1b Details Data Element Definitions	61
Table 19	Equation Y-2 Details Data Element Definitions	66
Table 20	Equation Y-3 Details Data Element Definitions	68
Table 21	Facility Level Roll-up Emissions Data Element Definitions	70

List of Figures

	<u>Page</u>
Figure 1	3
Figure 2	5
Figure 3	5
Figure 4	6
Figure 5	7
Figure 6	7
Figure 7	9
Figure 8	11
Figure 9	12
Figure 10	14
Figure 11	15
Figure 12	18
Figure 13	19
Figure 14	22
Figure 15	25
Figure 16	27
Figure 17	28
Figure 18	32
Figure 19	36
Figure 20	37
Figure 21	38
Figure 22	42
Figure 23	45
Figure 24	49
Figure 25	50
Figure 26	52
Figure 27	55
Figure 28	60
Figure 29	60
Figure 30	65
Figure 31	67
Figure 32	69

List of XML Excerpts

	<u>Page</u>
XML Excerpt 1 Example for “Unbounded” Parent Element	7
XML Excerpt 2 Example for Greenhouse Gas Information Details	13
XML Excerpt 3 Example for CEMS Unit Details	17
XML Excerpt 4 Example for Tier 4 CEMS Monitoring Location and Emissions	21
XML Excerpt 5 Example for Tier 4 CEMS Quarterly and Operating Hours Details	24
XML Excerpt 6 Example for Tier 4 CEMS Process Units Details	26
XML Excerpt 7 Example for Unit Identification and Emissions	31
XML Excerpt 8 Example for Product and Feedstock Details	35
XML Excerpt 9 Example for Product and Feedstock Monthly Details	41
XML Excerpt 10 Example for Additional Details	44
XML Excerpt 11 Example for Ethylene Combustion Methodology	48
XML Excerpt 12 Example for Flare Gas Unit Details	51
XML Excerpt 13 Example for Flare Gas Unit Emissions and Carbon Fraction Basis	54
XML Excerpt 14 Example for Equation Y-1a Details	59
XML Excerpt 15 Example for Equation Y-1b Details	64
XML Excerpt 16 Example for Equation Y-2 Details	67
XML Excerpt 17 Example for Equation Y-3 Details	68
XML Excerpt 18 Example for Facility Level Roll-up Emissions	70

I. Introduction

The U.S. Environmental Protection Agency's (EPA's) electronic greenhouse gas reporting tool (e-GGRT) extensible markup language (XML) Reporting Schema contains all of the data elements needed to comply with the Greenhouse Gas Reporting Program (GHGRP) beginning with the 2013 data collection year. The XML schema defines expected data elements and attributes, allowable data formats for each data element, and the hierarchical structure and sequence in which data elements must appear in the XML file. Similar to an architectural blueprint that describes the structural design of a house, an XML schema describes the structural design of an XML file. In some cases, it also defines which elements are optional and which are required and the maximum number of occurrences allowed for each element.

The e-GGRT XML schema is made up of a root data element (GHG) and complex and simple data elements. A simple element is a single piece of data. A complex element is a group of simple elements which are logically grouped together. The root data element is the base of the XML schema.

The schema's structure can be thought of as a family tree. The elements are related to each other in parent-child relationships. The root element is the parent element of the entire schema. Complex elements are children of the root element, and complex elements can also be children of other complex elements.

The XML upload method may be used for reporting a facility or supplier's annual GHG data; however, the following actions can only be performed using the e-GGRT web forms:

- User, facility and supplier registration
- Certificate of Representation and Notice of Delegation signing
- Facility representative and agent changes
- Facility and supplier address changes
- Notice of intent to not submit an annual report for RY20xx

All XML files submitted to e-GGRT must be well formed and will be accepted only if they conform to the current version of the e-GGRT XML schema.

An XML submission must only contain GHG data for a single facility or supplier. All data for a facility or supplier must be submitted in a single file as a complete report and must include all of the relevant Subparts. It is not possible to submit a subset of any portion of a facility's data to add, delete, correct or update. The entire report must be resubmitted to make any modification at all. Each subsequent submission for the same facility replaces all of the previously submitted data.

The e-GGRT XML schema contains enumerated lists of the units of measures for some data elements and allowable values for some data elements. For rules regarding the unit of measure or allowable values for a specific data element, please refer to the appropriate Data Element Definitions table.

The e-GGRT XML Reporting Schema is available for download at the e-GGRT help website: <http://www.ccdsupport.com/confluence/display/help/XML+Reporting+Instructions>. The zip file contains:

- **GHG_Final.xsd and Included Files**
- **SchemaChanges.xlsx**

Table 1
Reporting Numbers

Number Format	Description
Rounding	<ul style="list-style-type: none"> • CO₂e and CO₂ emissions data expressed in metric tons should be rounded to one decimal place. This should be done regardless of the level of data collection (e.g., unit-level, facility-level). Quantities less than 0.05 metric tons would round to 0.0 and be reported as such. Quantities greater than or equal to 0.05 metric tons would round up to 0.1 and be reported as such. • CH₄ emissions data expressed in metric tons should be rounded to two decimal places. • N₂O emissions data expressed in metric tons should be rounded to three decimal places. • Emissions data for all GHGs other than CO₂, N₂O, and CH₄ expressed in metric tons should be rounded to the fourth digit to the right of the decimal (one tenth of a kilogram, or 1 ten thousandth of a metric ton). This rounding should be applied regardless of the level of data collection (unit, facility, etc.). • Other (non-emissions) quantitative data reported by the user (e.g., a monthly HHV sample result, an annual production quantity) will not need to be rounded. • In the case of aggregation/roll-ups, those calculations should be performed on the rounded values.
Percentages	If a value must be reported as a percentage, then the number should be within the range of 0 to 100 (percent), e.g. 85.5% should be reported as 85.5.
Fractions	If a value must be reported as a decimal fraction, then the number should be within the range of 0 and 1, e.g., 1/4 should be reported as 0.25. Leading zeroes are optional.

Key XML Terms

- **XML:** A markup language for documents containing structured information. The XML specification defines a standard way to add markup to documents. Its primary purpose is to facilitate the sharing of structured data across different information systems, particularly via the internet.
- **XML Schema:** An XML schema describes the structure of an XML document. The schema also defines the set of rules to which the XML document must conform in order to be considered "valid".
- **XML file:** A file containing data organized into a structured document using XML markup.
- **Data Element:** An XML data element is used for storing and classifying data in an XML file. Opening and closing tags represent the start and end of a data element. An opening tag looks like <elementName>, while a closing tag has a slash that is placed before the element's name </elementName>. The following example shows how to report the facility's identification

number: <FacilitySiteIdentifier>23222</FacilitySiteIdentifier>. The information shaded in blue represents the data element's value.

If a data element does not contain a value, then a single empty tag name may be used. An empty tag has a slash placed after the element's name <FacilitySiteIdentifier/>. **Note:** If you do not intend to report a value for a particular data element, then it is recommended that you do not include the data element in the XML file.

- **Attribute:** An XML attribute contains additional information about a specific data element. An attribute for a data element is placed within the opening tag. The syntax for including an attribute in an element is <elementName attributeName="value">. For example, <TotalCH4CombustionEmissions massUOM="Metric Tons">.
- **Root/Parent/Child Element:** The schema's structure can be thought of as a family tree. At the top of the tree is some early ancestor and at the bottom of the tree are the latest children. With a tree structure you can see which children belong to which parents and many other relationships.

XML data elements are sometimes referenced in terms of how they relate to each other, e.g., parent-child relationships, within the schema's tree structure, also known as hierarchy. The top of the XML tree is considered the root – it is the parent to all data elements within the schema. In the example below, "GHG_Unit_Details" is the root, and just like in many other family trees, there is more than one item with the same name (e.g., "Unit_ID"). The easiest way to distinguish these items is by referencing them in terms of their parent-child relationships, e.g., NoCEMS /Unit_ID vs. CEMS/Unit_ID.

Figure 1
Example of an XML Tree

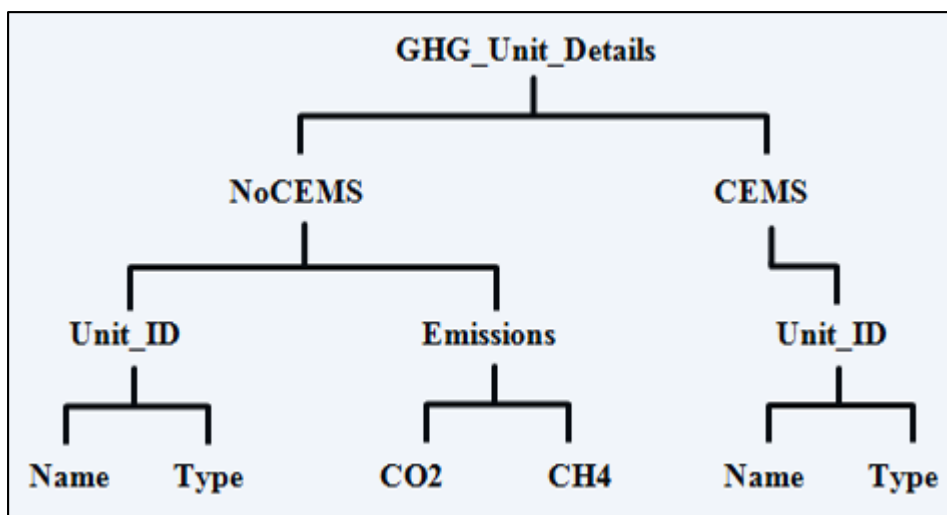

This document provides a step-by-step description of how to report emissions data using the XML schema. Please note the following:

- **Non-applicable data elements should not be included in the facility's XML file.** The schema contains many data elements, some of which may not be applicable to XML reporters in general or to a particular situation. If a data element is not referenced in the instructions (definition tables), then **do not** report or include it in the facility's XML file.
- **Data elements must be reported in a specific order.** The figures and tables in this document depict the specific sequence in which data elements must be arranged in the facility's XML file in order to produce a well-formed XML report.
- **Enumerations are case sensitive.** Many data elements have a defined set of allowable values, also known as enumerations. Values for enumerations must be entered exactly as they are defined within the schema (including punctuation marks) in order to be accepted by schema validation. See the definition tables for a complete list of enumerations.
- **Schema diagrams depict the hierarchy (or tree structure).** The primary purpose of the schema diagrams is to indicate the sequence in which data elements must appear within the facility's XML file and to identify the data elements that are required (must be reported) and conditionally required (see last bullet). Required data elements are boxed in red and conditionally required data elements are noted.
- **Definition tables provide details for required and conditionally required data elements.** The tables are designed to provide unique instructions for reporting a given data element, including the list of enumerations and required units of measure, if defined. As noted above, there are some data elements in the schema that are not applicable to XML reporters or to a particular situation. For example, the "OverrideIndicator" data element is used solely by e-GGRT to indicate that the web form reporter chose to override the system's calculated value with their own. These non-applicable data elements **are not** included in the definition tables. If a data element is not referenced in a definition table, then **do not** report or include it in the facility's XML file.
- **Commonly used data types are not depicted in the schema diagrams nor listed separately in the definition tables.** The schema diagrams display almost every data element in the schema except those that are associated with the three most commonly occurring data types:
 - Calculated Details
 - Measurement Details
 - Unit Identification Details

Once defined, these data types (static collection of data elements) are then associated as children to every data element in the schema containing a measured or calculated value or unit details. These child data elements do not appear in the diagrams and are not listed on separate rows in the definition tables in order to reduce their redundancy. They are however, referenced in the tables in the description of their parent data element. See Figures 2-4 and Tables 2-4.

- **Some data elements are conditionally required.** Data elements which are conditionally required are noted in the schema diagrams and the data element definitions tables. If your facility meets the condition specified for the data element, then the data element is required and you must report it in the facility's XML file. If your facility does not meet the condition specified for the data element, then **do not** include the data element in the facility's XML file. If a parent element is not required, then **do not** include any of its child data elements in the facility's XML file.

Figure 2
Calculated Details Data Type Schema Diagram

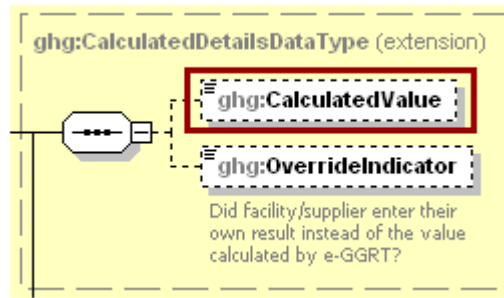

Note: Data elements boxed in red are required.

Table 2
Calculated Details Data Element Definitions

Data Element Name	Description
CalculatedDetailsDataType	
CalculatedValue	Calculated value (decimal).
OverrideIndicator	<p>Note: Do not include this data element in the facility’s XML file because it only applies to web form reporters. It is a flag set by e-GGRT to indicate that the system-calculated value was overridden with the web form reporter’s value.</p>

Figure 3
Measurement Details Data Type Schema Diagram

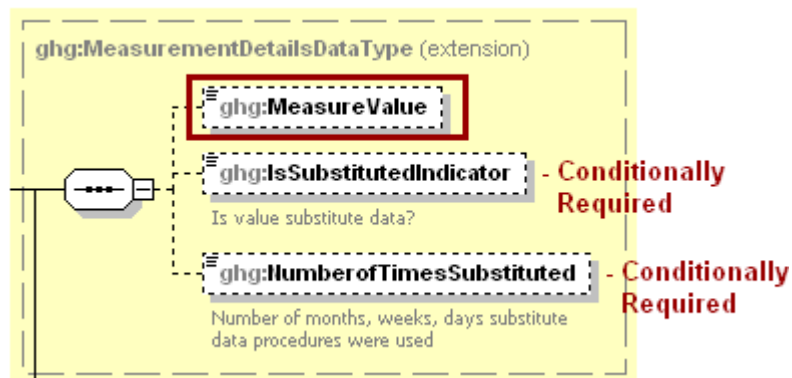

Note: Data elements boxed in red are required. Please see page 4 of this document for more information on conditionally required elements.

**Table 3
Measurement Details Data Element Definitions**

Data Element Name	Description
MeasurementDetailsDataType	
Measure Value	Measured value (decimal).
IsSubstitutedIndicator	An indication (Y/N) that the measure value contains substituted data. Note: Do not include this data element in your XML file unless noted in the instructions for the particular measured value.
NumberofTimesSubstituted	The number (integer) of days, months, weeks, or hours in the reporting year that missing data procedures were followed. Note: Do not include this data element in your XML file unless noted in the instructions for the particular measured value.

**Figure 4
Unit Identification Details Data Type Schema Diagram**

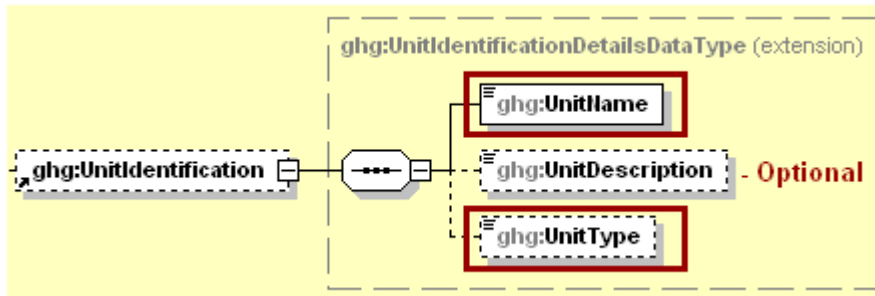

Note: Data elements boxed in red are required.

**Table 4
Unit Identification Details Data Element Definitions**

Data Element Name	Description
UnitIdentificationDetails	
UnitName	A unique name (ID) for each unit so that the data for different units can be recorded, maintained and retrieved clearly.
UnitDescription	Optional brief description of the unit.
UnitType	The type of unit. The list of allowable values varies. For more information, see the instructions for the specific unit process to be reported. For example, if reporting Flare Gas details, the unit type would be “Flare”.

The XML symbol “0..∞” shown in Figure 5 means that the parent element is “unbounded” so that multiple instances of the parent element can be reported. XML Excerpt 1 shows an example of reporting multiple instances of a parent element.

II. Summary of Changes

There were no changes to the Subpart X schema for reporting year 2021.

Please note that example screen images and XML examples sourced from or labeled with a prior reporting year are accurate for Reporting Year 2021.

III. Subpart X Overview

This document provides a step-by-step description of how to report data for Subpart X Petrochemical Production and overall total Subpart X greenhouse gas data for a facility using the XML schema.

Figure 7
Subpart X Reporting Diagram

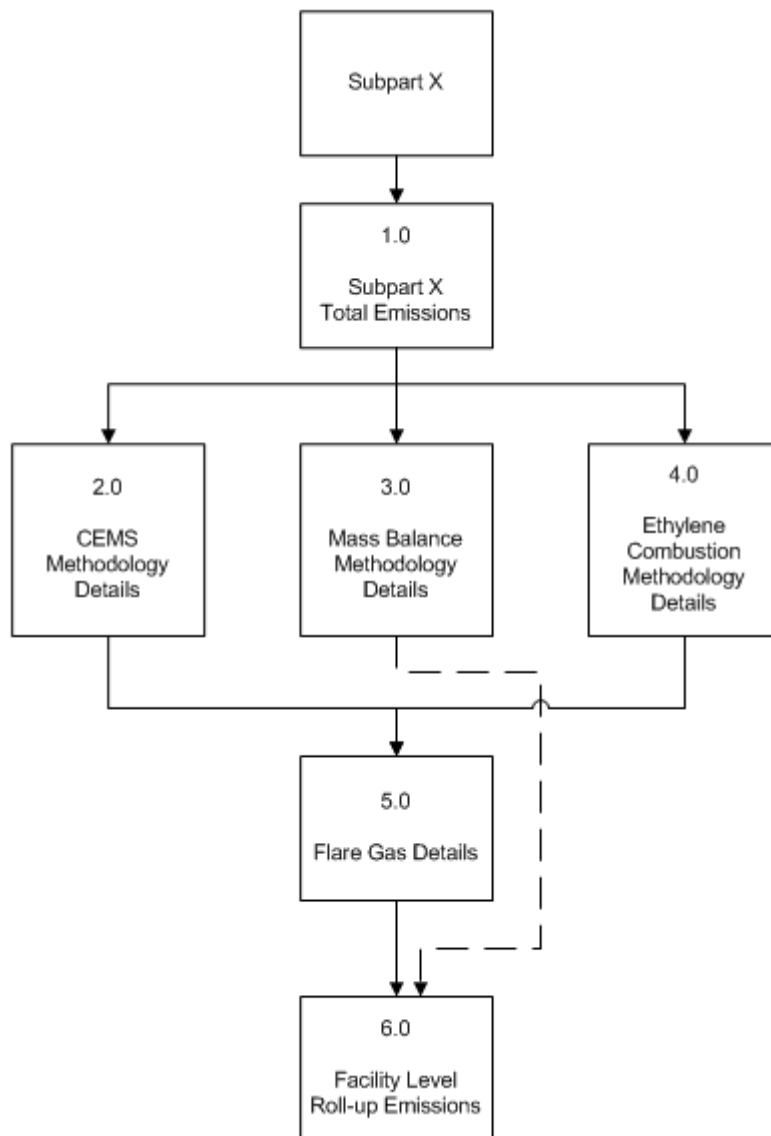

The XML schema includes the following areas for reporting for Subpart X, as displayed in the reporting diagram:

- 1.0 Subpart X Total Emissions: includes the total greenhouse gas emissions required to be reported for Subpart X.
- 2.0 CEMS Methodology Details: includes information on each petrochemical process unit for which the CEMS methodology of 98.243(b) was used to estimate emissions and on each CEMS monitoring location.
- 3.0 Mass Balance Methodology Details: includes information on each petrochemical process unit for which the mass balance methodology of 98.243(c) was used to estimate emissions.
- 4.0 Ethylene Combustion Methodology Details: includes information on each petrochemical process unit for which the combustion methodology for ethylene production of 98.243(d) was used to estimate emissions.
- 5.0 Flare Gas Details: includes information on each flare that burns process off-gas for each petrochemical process unit for which the CEMS methodology or the combustion methodology for ethylene production was used to estimate emissions.
- 6.0 Facility Level Roll-up Emissions: includes information on how to report total emissions for CO_{2e} (excluding biogenic CO₂) and biogenic CO₂ from Subpart X at the facility level.

Note 1: If your facility is subject to reporting under Subpart X (Petrochemical Production), EPA recommends that you also consider the following source categories in your facility applicability determination: Subpart C (General Stationary Fuel Combustion), Subpart G (Ammonia Manufacturing), and Subpart Y (Petroleum Refineries). These source categories are only provided as suggestions - additional Subparts may be relevant for a given facility/supplier and not all listed Subparts are relevant for all facilities/suppliers.

Note 2: If you are using a Best Available Monitoring Method (BAMM) in accordance with the rule in place of a method specified in Subpart X, then report "Other (specify)" for the relevant data element and report "BAMM" for the corresponding "Other" data element. Details regarding BAMM methods used should be included in Subpart A.

Figure 8
Subpart X Schema Diagram

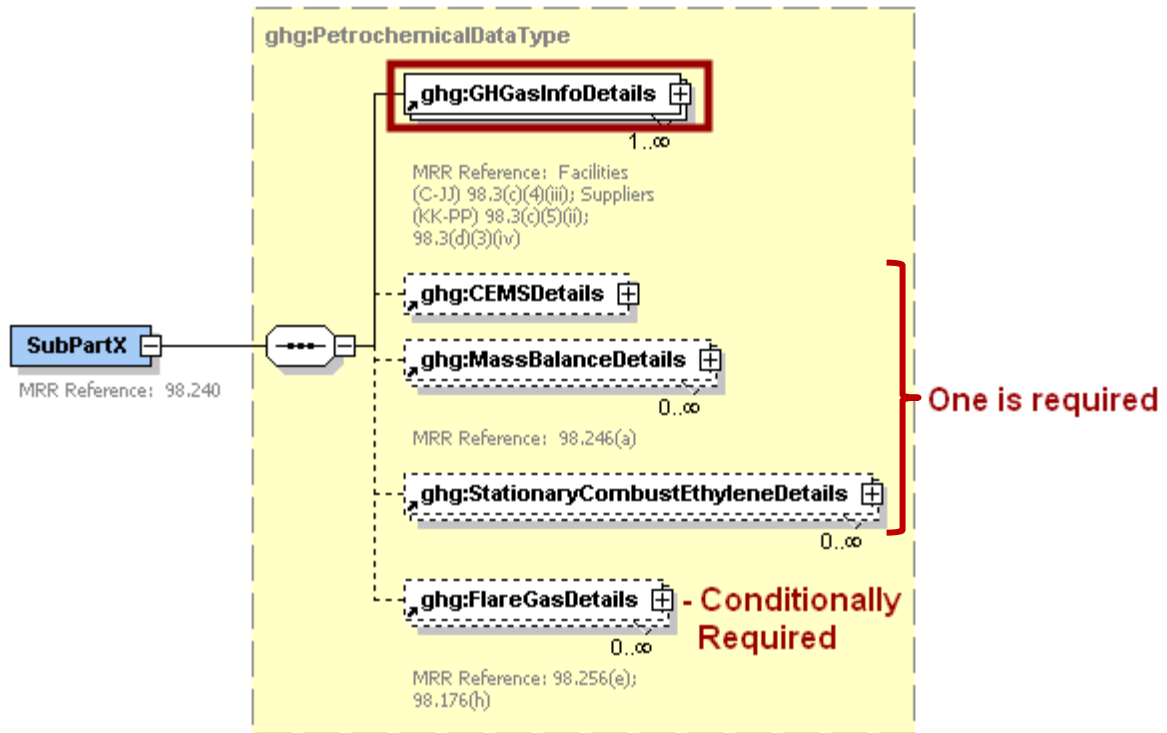

Note: Data elements boxed in red are required. Please see page 4 of this document for more information on conditionally required elements.

1.0 Subpart X Total Emissions

Greenhouse gas information details comprise a collection of data elements to report the total annual emissions of each greenhouse gas (GHG) listed in Table A-1 of 40 CFR 98 Mandatory Reporting of Greenhouse Gases reported under Subpart X, expressed in metric tons.

Figure 9
Greenhouse Gas Information Details Schema Diagram

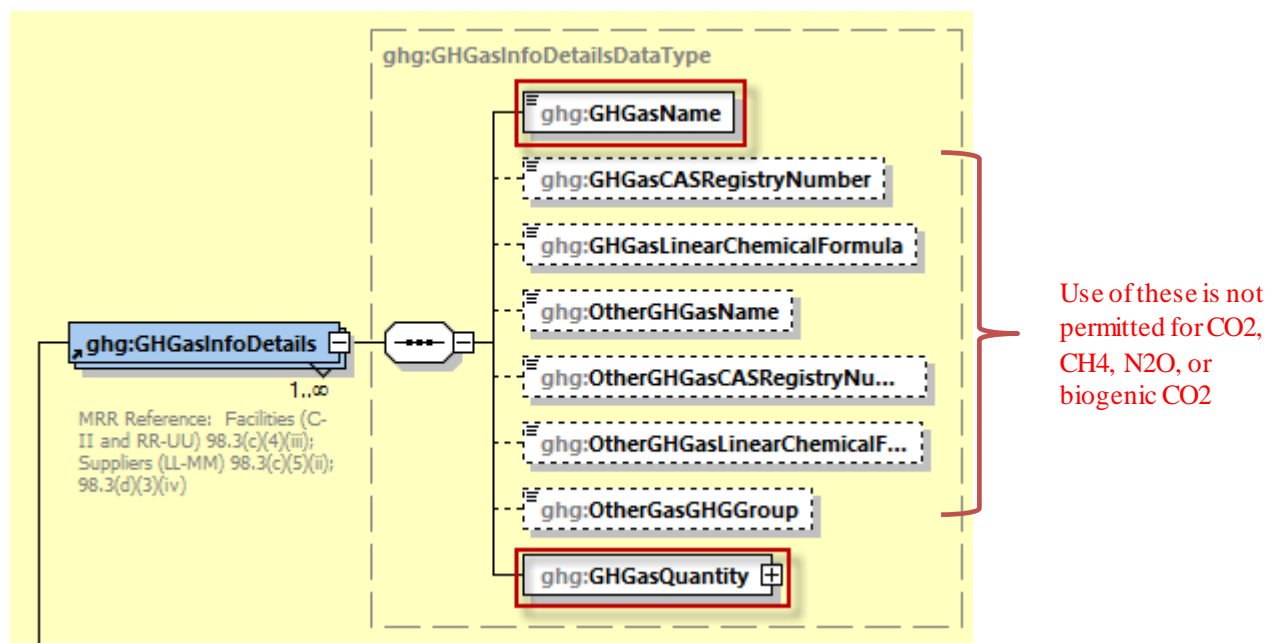

Note: Data elements boxed in red are required.

For Subpart X, report the gas name and emissions for biogenic carbon dioxide (CO₂), CO₂ (excluding biogenic CO₂), methane (CH₄) and nitrous oxide (N₂O); do NOT report the CAS Registry Number, Linear Chemical Formula, or the other gas data elements for CO₂, biogenic CO₂, CH₄, or N₂O. For greenhouse gas quantity, report the calculated value and mass unit of measure (Metric Tons) only according to the following guidelines:

- Total CO₂ emissions (excluding biogenic CO₂):
- Total biogenic CO₂ emissions:
- Total CH₄ emissions:
- Total N₂O emissions:

Note: You must follow the rounding rules found in [Table 1](#).

Table 5
Greenhouse Gas Information Details Data Element Definitions

Data Element Name	Description
GHGasInfoDetails	Parent Element: A collection of data elements containing the total annual emissions of each greenhouse gas (GHG) listed in Table A-1 of 40 CFR 98 Mandatory Reporting of Greenhouse Gases, reported under this Subpart, expressed in metric tons.
GHGasName	Specify the name of the GHG. See list of allowable values: Carbon Dioxide, Biogenic Carbon dioxide, Methane, and Nitrous Oxide.
GHGasQuantity	A collection of data elements that quantify the annual emissions from this source category. Report the value in the child data element CalculatedValue using the guidelines above. Set the units of measure to "Metric Tons" in the attribute massUOM .

Note: OtherGHGasName and OtherGas GHGGroup are not applicable to Subpart X

XML Excerpt 2
Example for Greenhouse Gas Information Details

```

<ghg:SubPartC>
  <ghg:GHGasInfoDetails>
    <ghg:GHGasName>Biogenic Carbon dioxide</ghg:GHGasName>
    <ghg:GHGasQuantity massUOM="Metric Tons">
      <ghg:CalculatedValue>14700.3</ghg:CalculatedValue>
    </ghg:GHGasQuantity>
  </ghg:GHGasInfoDetails>
  <ghg:GHGasInfoDetails>
    <ghg:GHGasName>Methane</ghg:GHGasName>
    <ghg:GHGasQuantity massUOM="Metric Tons">
      <ghg:CalculatedValue>4065.72</ghg:CalculatedValue>
    </ghg:GHGasQuantity>
  </ghg:GHGasInfoDetails>
  <ghg:GHGasInfoDetails>
    <ghg:GHGasName>Nitrous Oxide</ghg:GHGasName>
    <ghg:GHGasQuantity massUOM="Metric Tons">
      <ghg:CalculatedValue>398.581</ghg:CalculatedValue>
    </ghg:GHGasQuantity>
  </ghg:GHGasInfoDetails>
  <ghg:GHGasInfoDetails>
    <ghg:GHGasName>Carbon Dioxide</ghg:GHGasName>
    <ghg:GHGasQuantity massUOM="Metric Tons">
      <ghg:CalculatedValue>518460.9</ghg:CalculatedValue>
    </ghg:GHGasQuantity>
  </ghg:GHGasInfoDetails>

```

Note: The code excerpt above is presented here to demonstrate the concept of reporting greenhouse gas emissions data.

2.0 CEMS Methodology Details

Conditionally Required: This section describes information which must be reported if a continuous emissions monitoring system (CEMS) was in use during the reporting year (CEMS methodology of 98.243(b)). This method must be used if all process vent emissions and emissions from combustion of process off-gas is routed to one or more stacks and CEMS is used on each stack (except flare stacks) to measure CO₂ emissions.

Figure 10
CEMS Details Schema Diagram

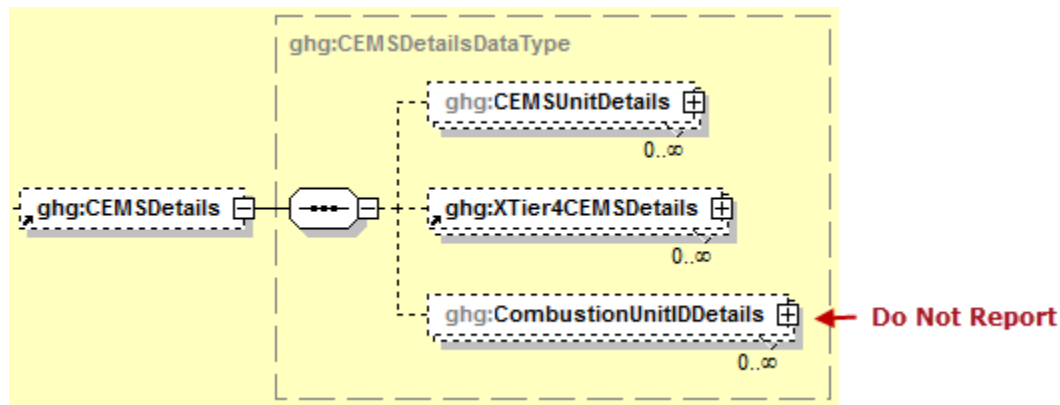

See the following figures for required data elements.

Subpart X requires the following identification information for each petrochemical process unit that had emissions monitored using a CEMS:

- A unique unit name or identifier (e.g., a unit ID number).
- An optional unit description or label.
- A code representing the type of unit: “Petrochemical process unit”.

For each petrochemical process unit, the facility must provide the following:

- The type of petrochemical produced from the following list [98.246(b)(1)]:
 - Methanol
 - Carbon Black
 - Acrylonitrile
 - Ethylene dichloride
 - Ethylene oxide
 - Ethylene
- The annual quantity of the petrochemical produced in metric tons [98.246 (b) (8)].

Figure 11
CEMS Unit Details Schema Diagram

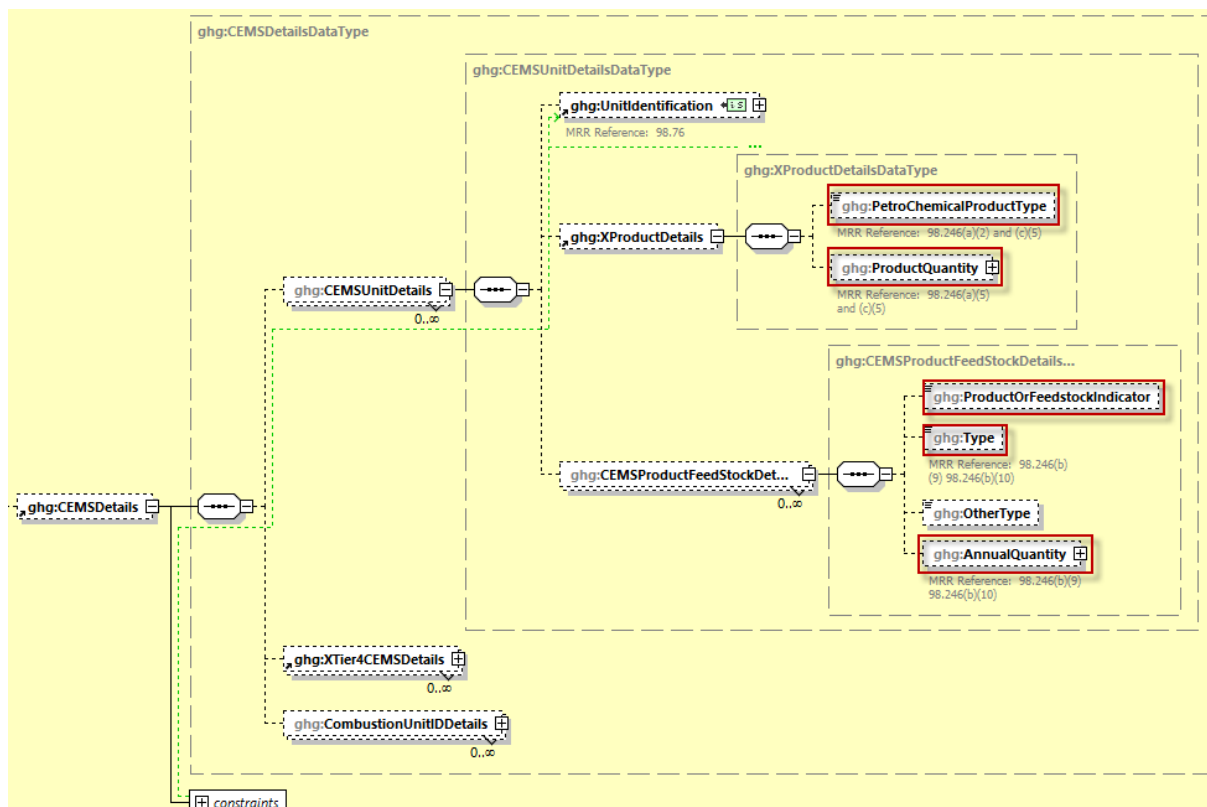

Note: Data elements boxed in red are required. Please see page 4 of this document for more information on conditionally required elements.

Table 6
CEMS Unit Details Data Element Definitions

Data Element Name	Description
CEMSDetails	Parent Element (Conditionally Required): A collection of data elements containing details about units which were monitored using a CEMS.
CEMSUnitDetails	Parent Element: A collection of data elements containing details about each unit which was monitored using a CEMS.
UnitIdentification	A collection of data elements containing the identity of each petrochemical process unit monitored by CEMS. Report a unique unit name (ID) in the child data element UnitName , an optional brief description in the child data element UnitDescription and the type of unit in the child data element UnitType : "Petrochemical process unit". The UnitName must be unique within the facility.
XProductDetails	Parent Element: A collection of data elements containing information about the petrochemical produced by the specified unit.

Data Element Name	Description
PetroChemicalProductType	<p>Type of petrochemical produced by the specified unit. See list of allowable values:</p> <ul style="list-style-type: none"> Methanol Carbon Black Acrylonitrile Ethylene dichloride Ethylene oxide Ethylene
ProductQuantity	<p>A collection of data elements containing information on the annual quantity of the petrochemical produced by the specified unit. Report the value in the child data element MeasureValue. Set the units of measure to “Metric Tons” in the attribute massUOM.</p>
EthyleneDichlorideProduced	<p>Not Applicable: EthyleneDichlorideProduced is not used for CEMS configurations.</p>
ProducedIntermediateQuantity	<p>Not Applicable: ProducedIntermediateQuantity is not used for CEMS configurations.</p>
CEMSProductFeedStockDetails	<p>Parent Element: A collection of data elements containing information about the product or feedstock used in the specified unit.</p>
ProductorFeedstockIndicator	<p>Indicator if the stream following is related to a product to feedstock: See list of allowable values:</p> <ul style="list-style-type: none"> Product Feedstock
Type	<p>The type of the specified carbon-containing feedstock and each carbon-containing product of the specified process unit (both the petrochemical and any other carbon-containing byproducts and liquid organic wastes). See list of allowable values:</p> <ul style="list-style-type: none"> Acetonitrile Acrylonitrile Benzene Butadiene Butane Carbon Black Carbon Black Oil Carbon Dioxide Coal Diesel Ethane Ethane/propane mix Ethanol Ethyl chloride Ethylene Ethylene dichloride Ethylene oxide Ethylene oxide and water solution Gas oil Heavy Gasoline Hydrogen Cyanide Methane Methanol Molasses

Data Element Name	Description
	Naphtha Natural gas Natural Gas Liquids Polypropylene Propane Propylene Pyrolysis gasoline Syngas Vegetable oil Vinyl chloride monomer Other
Other Type	Conditionally Required: The type of the specified carbon-containing feedstock or product if "Other" was reported for Type.
AnnualQuantity	The annual feedstock quantity.

*Note: Physical State was removed from this portion of the schema in 2017 and is not applicable CEMS in any reporting year.

XML Excerpt 3 Example for CEMS Unit Details

```

<CEMSUnitDetails>
  <UnitIdentification>
    <UnitName>CEMS1</UnitName>
    <UnitDescription>Test for EDC/CM</UnitDescription>
    <UnitType>Petrochemical process unit</UnitType>
  </UnitIdentification>
  <XProductDetails>
    <PetroChemicalProductType>Ethylene dichloride</PetroChemicalProductType>
    <ProductQuantity massUOM="Metric Tons">
      <MeasureValue>100</MeasureValue>
    </ProductQuantity>
  </XProductDetails>
  <CEMSProductFeedStockDetails>
    <ProductOrFeedstockIndicator>Feedstock</ProductOrFeedstockIndicator>
    <Type>Ethylene</Type>
    <AnnualQuantity massUOM="Metric Tons">
      <MeasureValue>77</MeasureValue>
    </AnnualQuantity>
  </CEMSProductFeedStockDetails>
  <CEMSProductFeedStockDetails>
    <ProductOrFeedstockIndicator>Product</ProductOrFeedstockIndicator>
    <Type>Ethylene dichloride</Type>
    <AnnualQuantity massUOM="Metric Tons">
      <MeasureValue>88</MeasureValue>
    </AnnualQuantity>
  </CEMSProductFeedStockDetails>
</CEMSUnitDetails>

```

Note: The code excerpt above is presented here to demonstrate the concept of reporting greenhouse gas emissions data.

Figure 12
Tier 4 CEMS Details Schema Diagram

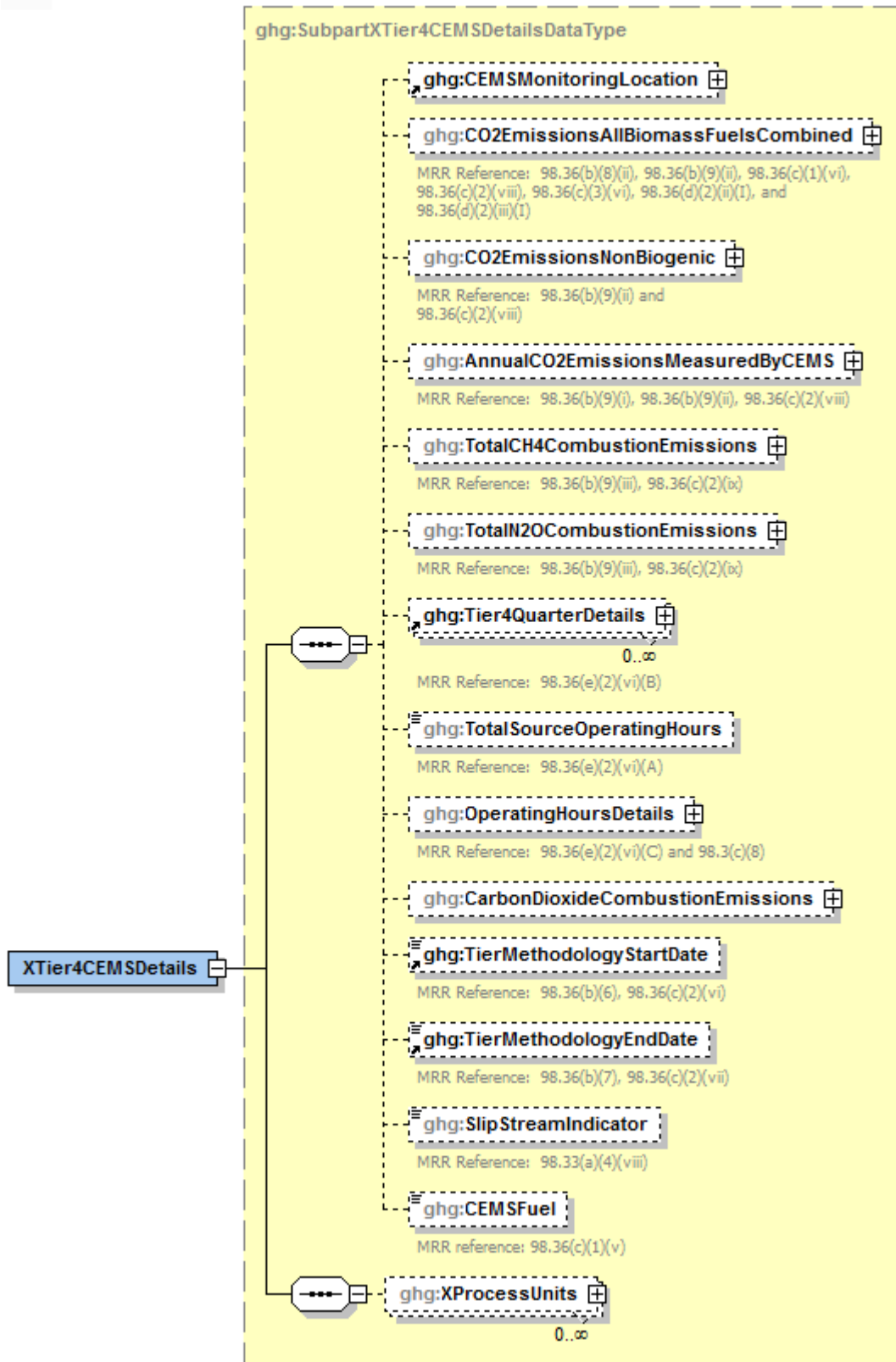

See the following figures for required data elements.

Figure 13
Tier 4 CEMS Monitoring Location and Emissions Schema Diagram

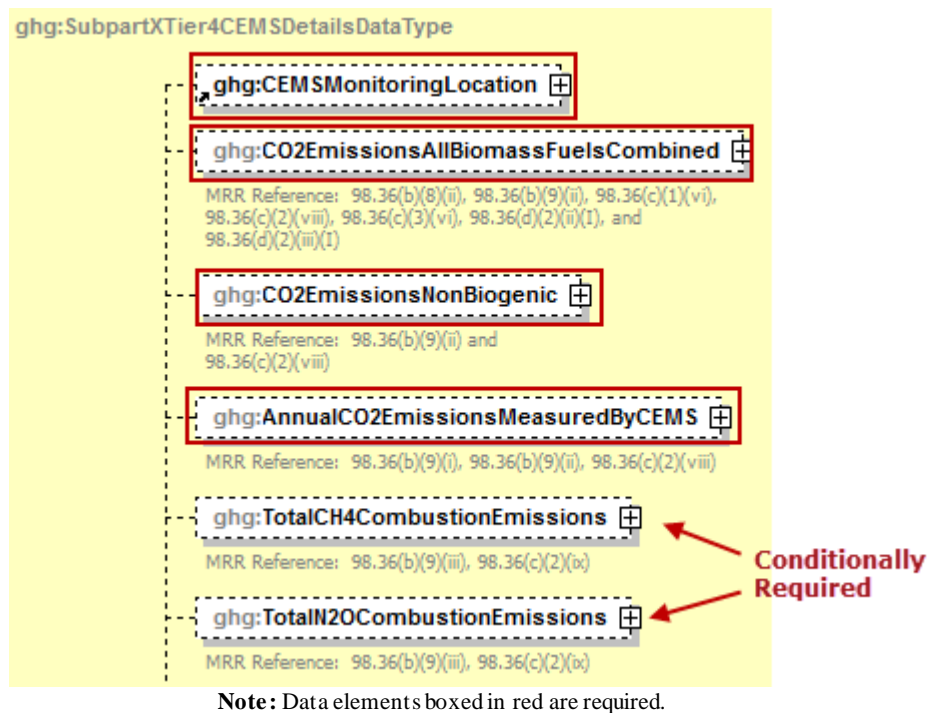

For Subpart X, information on each CEMS monitoring location (CML) is required including:

- A unique unit name or identifier for the CML.
- An optional description or label for the CML.
- The configuration of processes or process units that are monitored by the CML from the following list:
 - Single industrial process or process unit that exhausts to a dedicated stack.
 - Multiple industrial processes or process units share a common stack.
 - Industrial process or process unit shares a common stack with one or more stationary fuel combustion units.

For each CML identified, the following emissions data must be reported:

- The total annual CO₂ emissions from the combustion of all biomass fuels combined if biomass fuels are combusted in the configuration [98.36(b) (9) (ii), 98.36(c) (2) (viii)].
- The total annual non-biogenic CO₂ emissions (i.e. CO₂ emissions from fossil fuels, sorbent use, and process CO₂ emissions) [98.36(b) (9) (I)-(ii), 98.36(c) (2) (viii)].
- The total annual CO₂ emissions measured by the CEMS [98.36(b) (9) (I)-(ii), 98.36(c) (2) (viii)].
- **Conditionally Required:** If the process unit shares a stack with one or more combustion units, the total annual CH₄ emissions associated with the combustion of all Table C-2 fuels combusted in all combustion units monitored by the CEMS derived from application of Equation C-10 [98.246(b)(5)].
- **Conditionally Required:** If the process unit shares a stack with one or more combustion units, the total annual N₂O emissions associated with the combustion of all Table C-2 fuels combusted in all combustion units monitored by the CEMS derived from application of Equation C-10 [98.246(b)(5)].

Table 7
Tier 4 CEMS Monitoring Location and Emissions Data Element Definitions

Data Element Name	Description
XTier4CEMSDetails	Parent Element: A collection of data elements containing information about each CEMS monitoring location (CML). Report data for each CML separately.
CEMSMonitoringLocation	A collection of data elements containing the identity of each CEMS monitoring location. Report a unique CML name (ID) in the child data element Name , an optional brief description in the child data element Description and the type of configuration in the child data element Type . See the list of allowable configuration types: Single process/process unit exhausts to dedicated stack Multiple processes/process units share common stack Process/stationary combustion units share common stack
CO2EmissionsAllBiomassFuelsCombined	A collection of data elements containing information on the total annual biogenic CO ₂ emissions for the specified CEMS monitoring location. Report the value in the child data element CalculatedValue . Set the units of measure to “Metric Tons” in the attribute massUOM .
CO2EmissionsNonBiogenic	A collection of data elements containing information on the total annual non-biogenic CO ₂ emissions for the specified CEMS monitoring location. Report the value in the child data element CalculatedValue . Set the units of measure to “Metric Tons” in the attribute massUOM .
AnnualCO2EmissionsMeasuredByCEMS	A collection of data elements containing information on the total annual CO ₂ emissions measured by the CEMS at the specified CEMS monitoring location. Report the value in the child data element CalculatedValue . Set the units of measure to “Metric Tons” in the attribute massUOM .
TotalCH4CombustionEmissions	Conditionally Required: A collection of data elements containing information on the annual CH ₄ emissions at the specified CEMS monitoring location during the reporting year calculated using Equation C-10 expressed in mass of CH ₄ . Report the value in the child data element CalculatedValue . Set the units of measure to “Metric Tons” in the attribute massUOM . Report this information if the CML is a stack that is shared by the process unit and one or more combustion units.
TotalN2OCombustionEmissions	Conditionally Required: A collection of data elements containing information on the annual N ₂ O emissions at the specified CEMS monitoring location during the reporting year calculated using Equation C-10 expressed in mass of N ₂ O. Report the value in the child data element CalculatedValue . Set the units of measure to “Metric Tons” in the attribute massUOM . Report this information if the CML is a stack that is shared by the process unit and one or more combustion units.

XML Excerpt 4 Example for Tier 4 CEMS Monitoring Location and Emissions

```

<XTier4CEMSDetails>
  <CEMSMonitoringLocation>
    <Name>Monitoring Location 1 </Name>
    <Description>test</Description>
    <Type>Single process/process unit exhausts to dedicated stack</Type>
  </CEMSMonitoringLocation>
  <CO2EmissionsAllBiomassFuelsCombined massUOM="Metric Tons">
    <CalculatedValue>9</CalculatedValue>
  </CO2EmissionsAllBiomassFuelsCombined>
  <CO2EmissionsNonBiogenic massUOM="Metric Tons">
    <CalculatedValue>8</CalculatedValue>
  </CO2EmissionsNonBiogenic>
  <AnnualCO2EmissionsMeasuredByCEMS massUOM="Metric Tons">
    <CalculatedValue>10</CalculatedValue>
  </AnnualCO2EmissionsMeasuredByCEMS>
  <Tier4QuarterDetails>
    <QuarterName>First Quarter</QuarterName>
    <CumulativeCO2MassEmissions massUOM="Metric Tons">
      <CalculatedValue>1</CalculatedValue>
    </CumulativeCO2MassEmissions>
  </Tier4QuarterDetails>
  <Tier4QuarterDetails>
    <QuarterName>Second Quarter</QuarterName>
    <CumulativeCO2MassEmissions massUOM="Metric Tons">
      <CalculatedValue>2</CalculatedValue>
    </CumulativeCO2MassEmissions>
  </Tier4QuarterDetails>
</Tier4CEMSDetails>

```

Note: The code excerpt above is presented here to demonstrate the concept of reporting greenhouse gas emissions data.

Figure 14
Tier 4 CEMS Quarterly and Operating Hours Details Schema Diagram

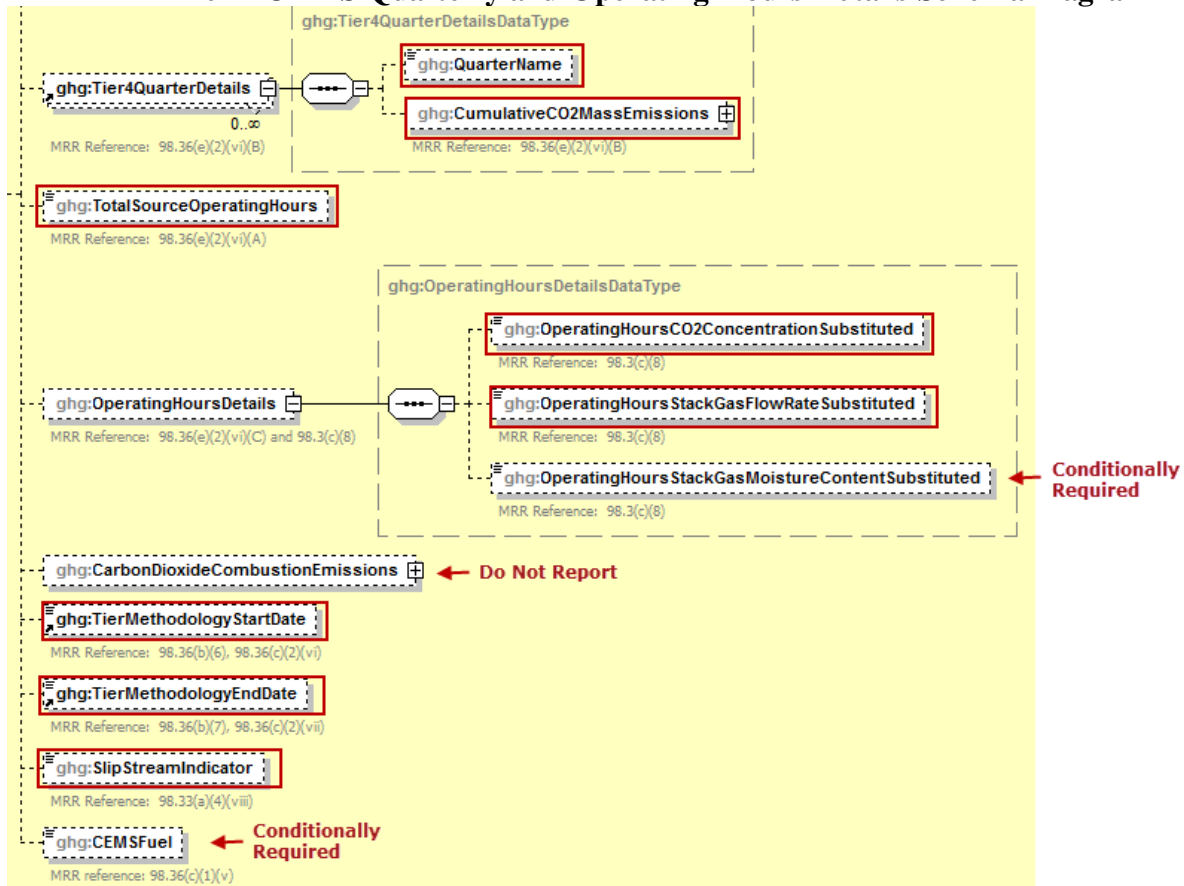

Note: Data elements boxed in red are required. Please see page 4 of this document for more information on conditionally required elements.

For each quarter of the reporting year, the facility must provide the cumulative CO₂ mass emissions for each CML [98.36(e) (2) (VI) (B)].

The facility must provide the following additional information for each CML:

- The total number of source operating hours in the reporting year [98.36(e)(2)(vi)(A)]
- The total operating hours in which a substitute data value was used in the emissions calculations for the CO₂ concentration parameter [98.36(e)(2)(vi)(C) and 98.3(c)(8)]
- The total operating hours in which a substitute data value was used in the emissions calculations for the stack gas flow rate parameter [98.36(e)(2)(vi)(C) and 98.3(c)(8)]
- **Conditionally Required:** If moisture correction is required and a continuous moisture monitor is used, the total operating hours in which a substitute data value was used in the emissions calculations for the stack gas moisture content parameter [98.36(e)(2)(vi)(C) and 98.3(c)(8)]
- The Tier 4 methodology start date [98.36(b)(6), 98.36(c)(2)(vi)]
- The Tier 4 methodology end date [98.36(b)(7), 98.36(c)(2)(vii)]
- Specify if emissions reported for the CEMS include emissions calculated according to 98.33(a)(4)(viii) for a slipstream that bypassed the CEMS [98.33(a)(4)(viii)]
- **Conditionally Required:** If the CML is a stack that is shared by the process unit and one or more combustion units, each type of fuel combusted in the group of units during the reporting year [98.36(c)(2)(iv)]

Table 8
Tier 4 CEMS Quarterly and Operating Hours Details Data Element Definitions

Data Element Name	Description
Tier4QuarterDetails	Parent Element: A collection of data elements which must be reported on a quarterly basis.
Quarter Name	The name of the quarter. See list of allowable values: First Quarter Second Quarter Third Quarter Fourth Quarter
CumulativeCO2MassEmissions	A collection of data elements containing information on the cumulative CO ₂ mass emissions for the specified CEMS monitoring location for the specified quarter of the reporting year. Report the value in the child data element CalculatedValue . Set the units of measure to “Metric Tons” in the attribute massUOM .
TotalSourceOperatingHours	The total number of source operating hours in the reporting year for the specified CEMS monitoring location.
OperatingHoursDetails	Parent Element: A collection of data elements containing information on substitute data values.
OperatingHoursCO2ConcentrationSubstituted	The total operating hours in which a substitute data value was used in the emissions calculations for the CO ₂ concentration parameter at the specified CEMS monitoring location.
OperatingHoursStackGasFlowRateSubstituted	The total operating hours in which a substitute data value was used in the emissions calculations for the stack gas flow rate parameter at the specified CEMS monitoring location.
OperatingHoursStackGasMoistureContentSubstituted	Conditionally Required: If moisture correction is required and a continuous moisture monitor is used, the total operating hours in which a substitute data value was used in the emissions calculations for the stack gas moisture content parameter at the specified CEMS monitoring location.
TierMethodologyStartDate	The tier methodology start date for the specified CEMS monitoring location (YYYY-MM-DD).
TierMethodologyEndDate	The tier methodology end date for the specified CEMS monitoring location (YYYY-MM-DD).
SlipStreamIndicator	An indication (Y/N) that the emissions reported for the CEMS include emissions calculated according to 98.33(a) (4) (viii) for a slipstream that bypassed the CEMS.
CEMSFuel	Conditionally Required: If the CML is a stack that is shared by the process unit and one or more combustion units, each type of fuel combusted in the group of units during the reporting year.

XML Excerpt 5 Example for Tier 4 CEMS Quarterly and Operating Hours Details

```

<Tier4QuarterDetails>
  <QuarterName>First Quarter</QuarterName>
  <CumulativeCO2MassEmissions massUOM="Metric Tons">
    <CalculatedValue>0</CalculatedValue>
  </CumulativeCO2MassEmissions>
</Tier4QuarterDetails>
<Tier4QuarterDetails>
  <QuarterName>Second Quarter</QuarterName>
  <CumulativeCO2MassEmissions massUOM="Metric Tons">
    <CalculatedValue>1</CalculatedValue>
  </CumulativeCO2MassEmissions>
</Tier4QuarterDetails>
<Tier4QuarterDetails>
  <QuarterName>Third Quarter</QuarterName>
  <CumulativeCO2MassEmissions massUOM="Metric Tons">
    <CalculatedValue>2</CalculatedValue>
  </CumulativeCO2MassEmissions>
</Tier4QuarterDetails>
<Tier4QuarterDetails>
  <QuarterName>Fourth Quarter</QuarterName>
  <CumulativeCO2MassEmissions massUOM="Metric Tons">
    <CalculatedValue>3</CalculatedValue>
  </CumulativeCO2MassEmissions>
</Tier4QuarterDetails>
<TotalSourceOperatingHours>0</TotalSourceOperatingHours>
<OperatingHoursDetails>
  <OperatingHoursCO2ConcentrationSubstituted>1</OperatingHoursCO2ConcentrationSubstituted>
  <OperatingHoursStackGasFlowRateSubstituted>2</OperatingHoursStackGasFlowRateSubstituted>
  <OperatingHoursStackGasMoistureContentSubstituted>3</OperatingHoursStackGasMoistureContentSubstituted>
</OperatingHoursDetails>
<TierMethodologyStartDate>2017-01-01</TierMethodologyStartDate>
<TierMethodologyEndDate>2017-12-31</TierMethodologyEndDate>
<SlipStreamIndicator>N</SlipStreamIndicator>
  <CEMSFuel>NONE</CEMSFuel>

```

Note: The code excerpt above is presented here to demonstrate the concept of reporting greenhouse gas emissions data.

Figure 15
Tier 4 CEMS Process Units Details Schema Diagram

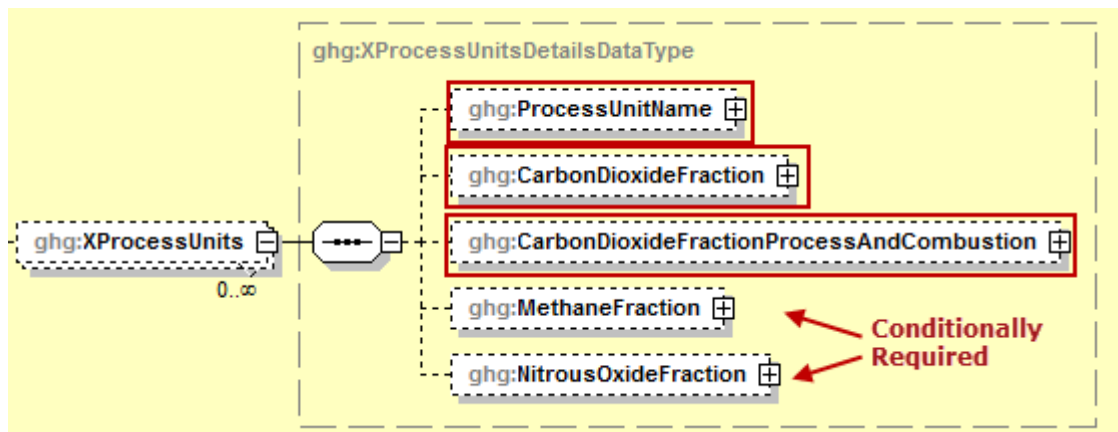

Note: Data elements boxed in red are required. Please see page 4 of this document for more information On conditionally required elements.

For each CML that is monitoring a Subpart X petrochemical process unit, report the following for each process unit:

- The name/ID of each process unit monitored at the CML. **Note:** Use the same identification for each unit as was used for the parent element “CEMSUnitDetails”.
- An estimate based on engineering judgment of the fraction of the total CO₂ emissions that results from CO₂ directly emitted by the petrochemical process unit plus CO₂ generated by the combustion of off-gas from the petrochemical process unit [98.246(b)(4)]
- **Conditionally Required:** If the CML is a stack that is shared by the process unit and one or more combustion units, the fraction of the calculated methane emissions from the CML that are attributable to combustion of the off-gas from the petrochemical process unit [98.246(b)(5)].
- **Conditionally Required:** If the CML is a stack that is shared by the process unit and one or more combustion units, the fraction of the calculated nitrous oxide emissions from the CML that are attributable to combustion of the off-gas from the petrochemical process unit [98.246(b)(5)].

Table 9
Tier 4 CEMS Process Units Details Data Element Definitions

Data Element Name	Description
XProcessUnits	Parent Element: A collection of data elements for process units monitored at the specified CEMS monitoring location. Report data for each process unit separately.
ProcessUnitName	Parent Element: A collection of data elements for each process unit monitored at the specified CEMS monitoring location.
UnitName	The name of each process unit that is monitored at the specified CEMS monitoring location (CML). Note: Use the same identification for each unit as was used for the parent element “CEMSUnitDetails”. The UnitName must be unique within the facility.
CarbonDioxideFractionProcessAndCombustion	A collection of data elements describing the fraction of the total CO ₂ emissions that results from CO ₂ directly emitted by the petrochemical process unit plus CO ₂ generated by the combustion of off-gas from the petrochemical process unit. Report the value in the child data element MeasureValue . Set the units of measure to “decimal fraction” in the attribute fractionUOM .
MethaneFraction	Conditionally Required: If the CML is a stack that is shared by the process unit and one or more combustion units, the fraction of CH ₄ emissions from the CML attributable to combustion of the off-gas from the specified petrochemical process unit. Report the value in the child data element MeasureValue . Set the units of measure to “decimal fraction” in the attribute fractionUOM .
NitrousOxideFraction	Conditionally Required: If the CML is a stack that is shared by the process unit and one or more combustion units, the fraction of N ₂ O emissions from the CML attributable to combustion of the off-gas from the specified petrochemical process unit. Report the value in the child data element MeasureValue . Set the units of measure to “decimal fraction” in the attribute fractionUOM .

XML Excerpt 6
Example for Tier 4 CEMS Process Units Details

```

<XProcessUnits>
  <ProcessUnitName>
    <UnitName>CEMS1</UnitName>
  </ProcessUnitName>
  <CarbonDioxideFractionProcessAndCombustion fractionUOM="decimal fraction">
    <MeasureValue>0.6</MeasureValue>
  </CarbonDioxideFractionProcessAndCombustion>
  <MethaneFraction fractionUOM="decimal fraction">
    <MeasureValue>0.8</MeasureValue>
  </MethaneFraction>
  <NitrousOxideFraction fractionUOM="decimal fraction">
    <MeasureValue>0.7</MeasureValue>
  </NitrousOxideFraction>
</XProcessUnits>

```

Note: The code excerpt above is presented here to demonstrate the concept of reporting greenhouse gas emissions data.

3.0 Mass Balance Methodology Details

Conditionally Required: This section describes information which must be reported for each petrochemical process unit for which the mass balance methodology of 98.243(c) was used. This method must be used if the total emissions from process vents and emissions from combustion of process off-gas are not routed to stacks that are monitored with CEMS (except flare stacks) to measure CO₂ emissions and the unit is not producing ethylene.

Figure 16
Mass Balance Methodology Schema Diagram

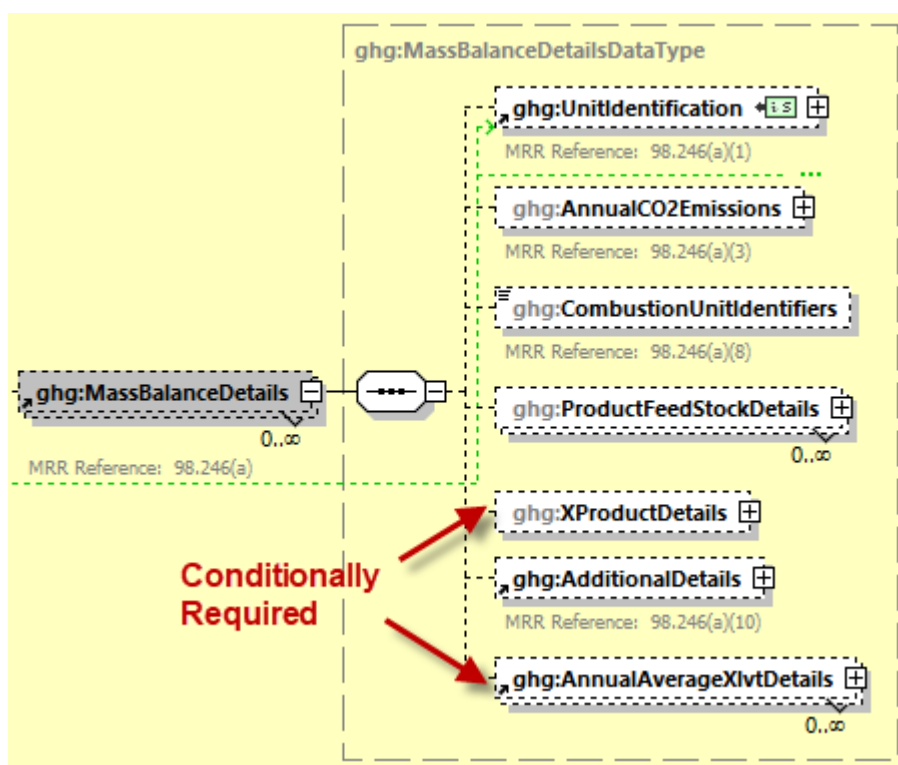

Subpart X requires the following identification information for each petrochemical process unit for which the mass balance methodology of 98.243(c) was used:

- A unique unit name or identifier (e.g., a unit ID number).
- An optional unit description or label.
- A code representing the type of unit: “Petrochemical process unit”.

Report the annual CO₂ mass emissions for each petrochemical process unit (the output of Equation X-4) [98.246(a) (3)]. Process emissions include CO₂ generated by reaction in the process and by combustion of process off-gas in stationary combustion units and flares.

For each petrochemical process unit, identify each combustion configuration that burned both process off-gas from the petrochemical process unit and supplemental fuel by providing the name/identifier of the combustion configuration as reported under Subpart C [98.246(a)(8)].

Figure 17
Unit Identification and Emissions Schema Diagram

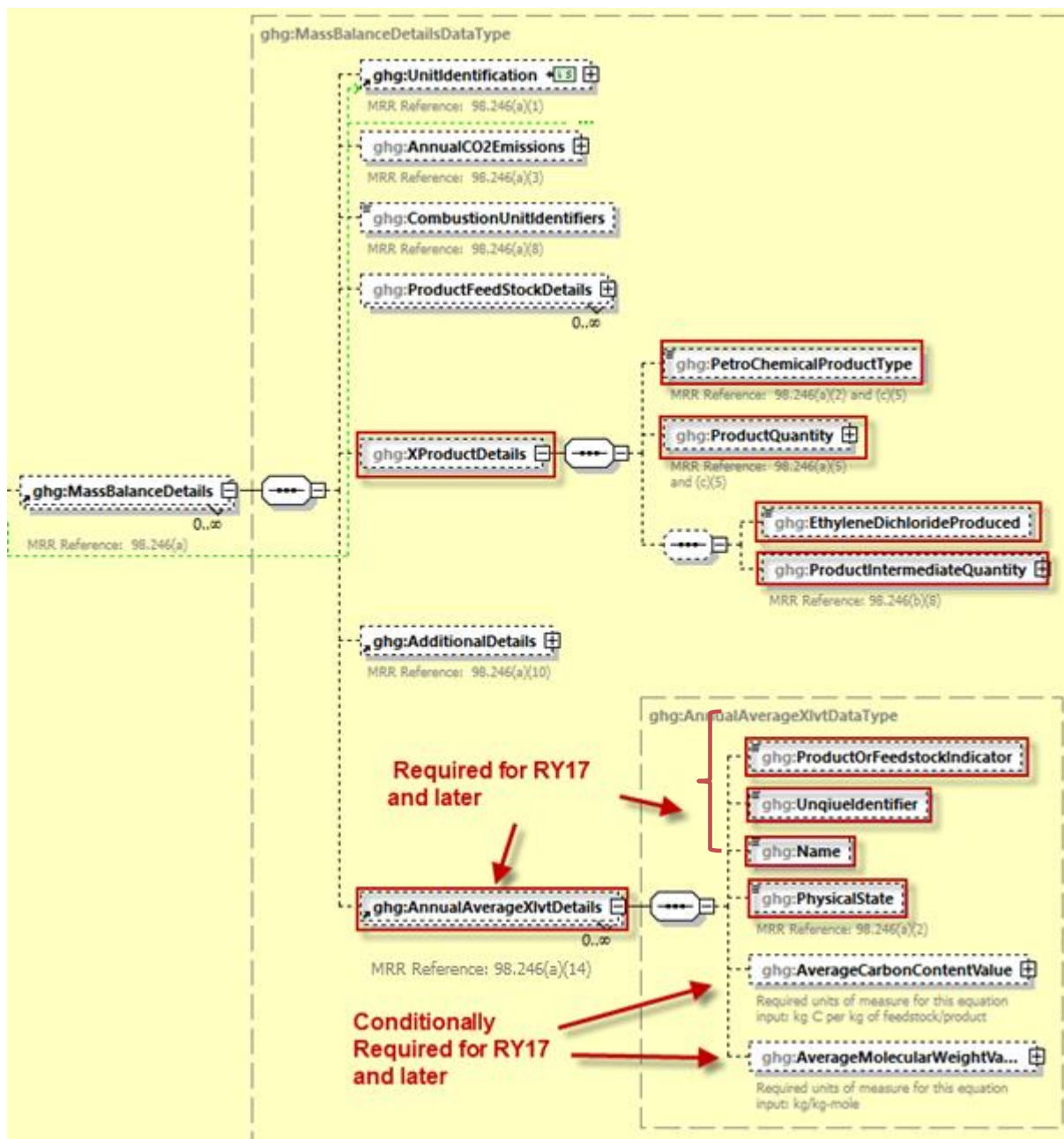

Note: Data elements boxed in red are required. Please see page 4 of this document for more information on conditionally required elements.

For each petrochemical process unit, report the following:

- The type of petrochemical produced (Methanol, Carbon black, Acrylonitrile, Ethylene dichloride, Ethylene oxide, or Ethylene) [98.246(a) (2)].
- The annual quantity of the petrochemical produced [98.246(a) (5)].
- If Ethylene Dichloride is produced, indicate if it is produced in a stand-alone process or an integrated Ethylene Dichloride / Vinyl Chloride monomer process and if a integrated process is indicated report the amount of intermediate Ethylene Dichloride produced [98.246(b)(8)].

Table 10
Unit Identification, Emissions, and Product Definitions Data Element Definitions

Data Element Name	Description
MassBalanceDetails	Parent Element (Conditionally Required): A collection of data elements containing information on each unit for which the mass balance methodology was used to monitor emissions. Report data for each unit separately.
UnitIdentification	A collection of data elements containing the identity of a petrochemical process unit. Report a unique unit name (ID) in the child data element UnitName , an optional brief description in the child data element UnitDescription and the type of unit in the child data element UnitType : "Petrochemical process unit". The UnitName must be unique within the facility.
AnnualCO2Emissions	A collection of data elements containing information on annual CO ₂ mass emissions from process operations and process off-gas combustion from the specified unit calculated using Equation X-4. Report the value in the child data element CalculatedValue . Set the units of measure to "Metric Tons" in the attribute mass UOM .
CombustionUnitIdentifiers	Identify each combustion configuration that burned both process off-gas from the petrochemical process unit and supplemental fuel by providing the name/identifier of those configurations as reported under Subpart C. If there aren't any, specify "None".
ProductFeedStockDetails	Parent Element: A collection of data elements containing information about the product or feedstock used in the specified unit. <i>See Figure 18, Table 12, and Excerpt 8 for more information</i>
XProductDetails	Parent Element: A collection of data elements containing information about the petrochemical produced by the specified unit.
PetroChemicalProductType	Type of petrochemical produced by the specified unit. See list of allowable values: Methanol Carbon Black Acrylonitrile Ethylene dichloride Ethylene oxide Ethylene Ethylene dichloride (integrated EDC/VCM process) Ethylene dichloride (stand-alone EDC process) Note: Ethylene dichloride is valid for RY2019 and prior years. For RY2020 and later indicate 'Ethylene dichloride (integrated EDC/VCM process)' or 'Ethylene dichloride (stand-alone EDC process)' for Ethylene dichloride processes.
ProductQuantity	Conditionally Required: If the type of petrochemical produced is not Ethylene dichloride, or if Ethylene dichloride is produced using the Stand-alone EDC Process, the annual quantity of the petrochemical product is reported in the child data element, MeasureValue , in metric tons.

EthyleneDichlorideProduced	Conditionally Required: If Ethylene dichloride is the petrochemical produced, users must additionally provide the process used to produce Ethylene dichloride. For RY2019 and prior years the allowable values include: Stand-alone EDC Process or Integrated EDC / VCM Process. For RY2020 and later this data element must be omitted.
ProductIntermediateQuantity	Conditionally Required: if Ethylene dichloride is the type of petrochemical produced, and an integrated EDC/VCM process was reported: for RY2019 and prior years report the value of the intermediate Ethylene dichloride produced in the child data element, MeasureValue , in metric tons. For RY2020 and later this data element must be omitted.
AdditionalDetails	Parent Element: A collection of data elements which must be reported on a monthly basis. Report data for each month separately. <i>See Table 14, Figure 22, and Excerpt 10 for more information.</i>
AnnualAverageXlvDetails	Parent Element (Required for RY17 and later): A collection of data elements containing information on each unit for which the mass balance methodology was used to monitor emissions. Report data for each unit separately.
ProductOrFeedStockIndicator	Required for RY17 and later: Indicate whether the component being measured is a product or a feedstock, using the allowable values: Product Feedstock
UniqueIdentifier	Required for RY17 and later: A collection of data elements containing the identity of each flare. Report a unique unit name (ID) in the child data element UnitName , an optional brief description in the child data element UnitDescription and the type of unit in the child data element UnitType : "Flare".
Name	Required for RY17 and later: Name of the Feedstock
PhysicalState	Required for RY17 and later: Provide the state of the specified carbon-containing feedstock or product. Allowable values include: Solid, Liquid, or Gaseous
AverageCarbonContentValue	Conditionally Required: A collection of data elements containing information on the Average Carbon Content for the specified feedstock or product. Report the value in the child data element CalculatedValue .
AverageMolecularWeightValue	Conditionally Required: A collection of data elements containing information on the Average Molecular Weight for the specified feedstock or product. Report if a gaseous stream is measured as a volume. Report the value in the child data element CalculatedValue .

XML Excerpt 7

Example for Unit Identification, Emissions, and Product Details

```

UnitIdentification >
  <UnitName>Mass1, Stand alone EDC</UnitName >
  <UnitType>Petrochemical process unit</UnitType >
</UnitIdentification >
<AnnualCO2Emissions massUOM="Metric Tons">
  <CalculatedValue>0.0</CalculatedValue >
</AnnualCO2Emissions >
<CombustionUnitIdentifiers>None</CombustionUnitIdentifiers >
<ProductFeedStockDetails >
  <ProductOrFeedstockIndicator>Feedstock</ProductOrFeedstockIndicator >
  <Name>1</Name >
  <Type>Ethylene dichloride</Type >
  <AnnualQuantity massUOM="Metric Tons">
    <MeasureValue>40</MeasureValue >
  </AnnualQuantity >
  <PhysicalState >Solid</PhysicalState >
  <FlowMeterDetails >
    <FlowOrMassDeterminationMethod >test</FlowOrMassDeterminationMethod >
  </FlowMeterDetails >
  <ProcessChangeDates >test</ProcessChangeDates >
  <MonthlyDetails >
    <MonthName>January</MonthName >
    <OtherProductFeedStockDetails >
      <VolumeorMass >
        <IsSubstitutedIndicator>N</IsSubstitutedIndicator >
      </VolumeorMass >
      <VolumeorMassMethod >Tank level measurements</VolumeorMassMethod >
      <CarbonContent >
        <IsSubstitutedIndicator>N</IsSubstitutedIndicator >
      </CarbonContent >
      <CarbonContentMethod >SW-846 Method 8 031</CarbonContentMethod >
      <MolecularWeight >
        <IsSubstitutedIndicator>N</IsSubstitutedIndicator >
      </MolecularWeight >
    </OtherProductFeedStockDetails >
  </MonthlyDetails >
</ProductFeedStockDetails >
<XP roductDetails >
  <PetroChemicalProductType >Ethylene dichloride (integrated EDC/VCM process)</PetroChemicalProductType >
</XP roductDetails >
OR
<XP roductDetails >
  <PetroChemicalProductType >Ethylene dichloride</PetroChemicalProductType >
  <EthyleneDichlorideProduced >Integrated EDC/VCM Process</EthyleneDichlorideProduced >
  <ProductIntermediateQuantity massUOM="Metric Tons">
    <MeasureValue>25</MeasureValue >
  </ProductIntermediateQuantity >
</XP roductDetails >
OR
<XP roductDetails >
  <PetroChemicalProductType >Ethylene dichloride</PetroChemicalProductType >
  <ProductQuantity massUOM="Metric Tons">
    <MeasureValue>100</MeasureValue >
  </ProductQuantity >
  <EthyleneDichlorideProduced >Stand-alone EDC Process</EthyleneDichlorideProduced >
</XP roductDetails >
OR
<XP roductDetails >
  <ghg:XP roductDetails >
    <ghg:P etroChemicalProductType >Carbon Black</ghg:P etroChemicalProductType >
    <ghg:P roductQuantity massUOM="Metric Tons">
      <ghg:MeasureValue >2000</ghg:MeasureValue >
    </ghg:P roductQuantity >
  </ghg:XP roductDetails >

```

Note: The code excerpt above is presented here to demonstrate the concept of reporting greenhouse gas emissions data.

Figure 18
Product and Feedstock Details Schema Diagram

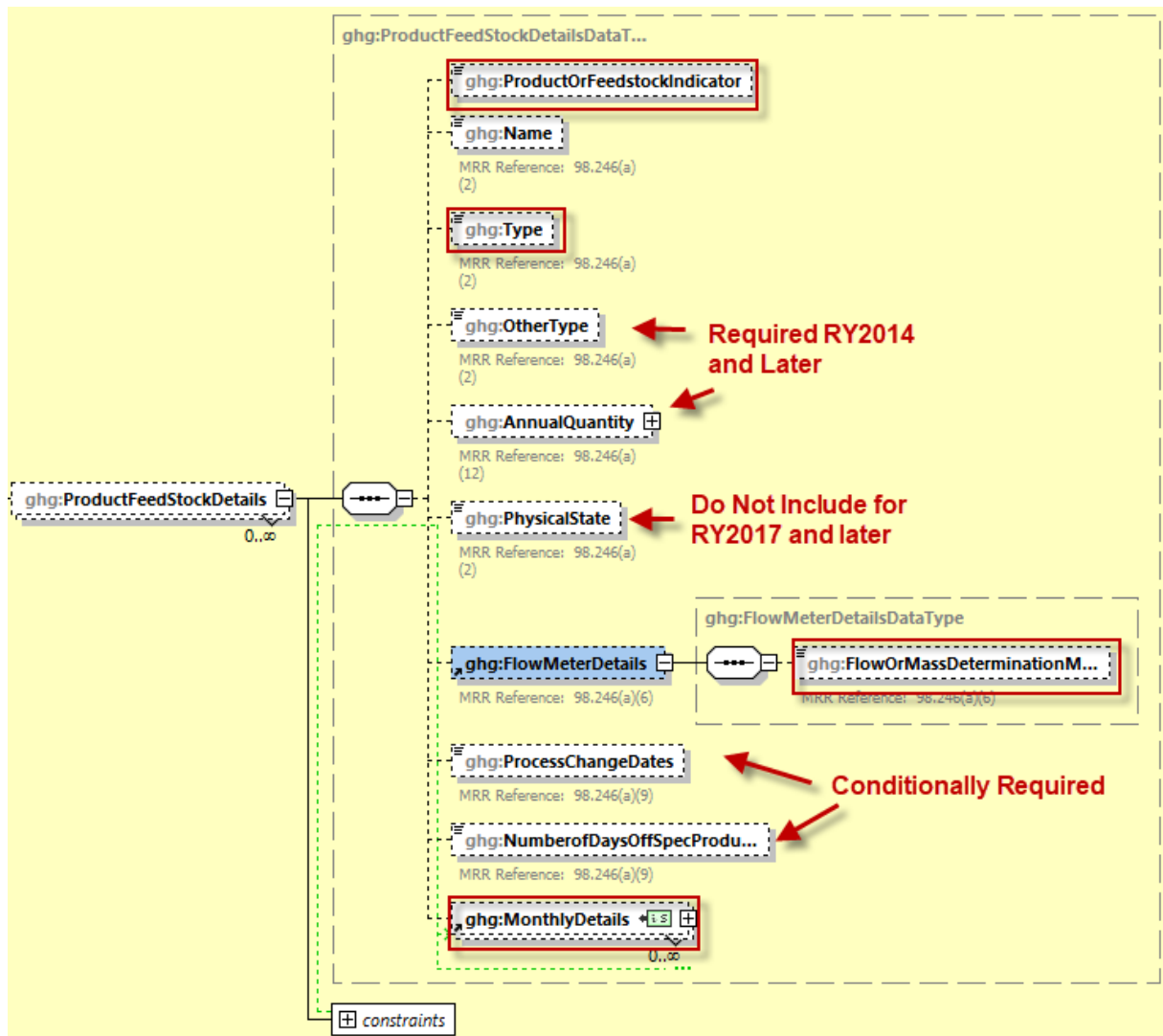

Note: Data elements boxed in red are required. Please see page 4 of this document for more information on conditionally required elements.

For each petrochemical process unit for which the facility specified the mass balance methodology, provide the following:

- An indication whether the component being measured is a product or a feedstock.
- The type of each carbon-containing feedstock to the petrochemical process unit [98.246(a)(2)].
- The type of petrochemical produced [98.246(a)(2)].
- The type of each other carbon-containing product of the petrochemical process unit [98.246(a)(2)].
- The annual quantity of feedstock.
- An indication of whether each carbon-containing feedstock, petrochemical product and other carbon-containing product were solid, liquid, or gaseous.

For each volume or mass measurement device, provide the following:

- Name or other identification of method used to determine volume or mass.

Conditionally Required: For each feedstock or product for which the facility used the alternative to sampling method specified in 98.243(c) (4), report the following:

- The date of each process change that reduced the monthly average composition to less than 99.5 percent [98.246(a) (9)].

Conditionally Required: For each product for which the facility used the alternative to sampling method specified in 98.243(c) (4), report the following:

- The number of days during which off-specification product was produced [98.246(a) (9)].

Table 11
Product and Feedstock Details Data Element Definitions

Data Element Name	Description
ProductFeedStockDetails	Parent Element: A collection of data elements containing information on each carbon-containing feedstock for and product of the specified unit. Report data for each product or feedstock separately.
ProductOrFeedstockIndicator	Indicate whether the component being measured is a product or a feedstock, using the allowable values: Product Feedstock

Data Element Name	Description
Type	<p>The type of the specified carbon-containing feedstock and each carbon-containing product of the specified process unit (both the petrochemical and any other carbon-containing byproducts and liquid organic wastes). See list of allowable values:</p> <ul style="list-style-type: none"> Acetonitrile Acrylonitrile Benzene Butadiene Butane Carbon Black Carbon Black Oil Carbon Dioxide Coal Diesel Ethane Ethane/propane mix Ethanol Ethyl chloride Ethylene Ethylene dichloride Ethylene oxide Ethylene oxide and water solution Gas oil Heavy Gasoline Hydrogen Cyanide Methane Methanol Molasses Naphtha Natural gas Natural Gas Liquids Polypropylene Propane Propylene Pyrolysis gasoline Syngas Vegetable oil Vinyl chloride monomer Other
OtherType	<p>Conditionally Required: The type of the specified carbon-containing feedstock or product if "Other" was reported for Type.</p>
AnnualQuantity	<p>The annual feedstock or product quantity.</p>
PhysicalState	<p>This data element should not be used in 2017 or any following years. This data element is included in the schema to support historical reporting up to and including reporting year 2016. For prior years provide the state of the specified carbon-containing feedstock or product. Allowable values include: Solid, Liquid, or Gaseous.</p>

Data Element Name	Description
FlowMeterDetails	Parent Element (Conditionally Required): A collection of data elements containing weighing device, flow meter and tank level measurement device details. If a weighing device, flow meter or tank level measurement device was used at any point during the year to measure the mass or volume of the feedstock or product, then report the following. Otherwise, do not report this parent element.
FlowOrMassDeterminationMethod	Name or other identification of method used to determine mass or volume.
ProcessChangeDates	Conditionally Required: If you comply with the alternative to sampling and analysis specified in 98.243(c)(4) and if applicable, report the dates for each process change that reduced the monthly average composition of the specified feedstock or product to less than 99.5% of the specific compound.
NumberofDaysOffSpecProductProduced	Conditionally Required: If you comply with the alternative to sampling and analysis specified in 98.243(c)(4) for a product and if applicable, report the number of days during which off-specification product was produced

XML Excerpt 8 Example for Product and Feedstock Details

```

<ProductFeedStockDetails>
  <ProductOrFeedstockIndicator>Feedstock</ProductOrFeedstockIndicator>
  <Name>1</Name>
  <Type>Ethylene dichloride</Type>
  <AnnualQuantity massUOM="Metric Tons">
    <MeasureValue>40</MeasureValue>
  </AnnualQuantity>
  <PhysicalState>Solid</PhysicalState>
  <FlowMeterDetails>
    <FlowOrMassDeterminationMethod>test</FlowOrMassDeterminationMethod>
  </FlowMeterDetails>
  <ProcessChangeDates>test</ProcessChangeDates>
  <MonthlyDetails>
    <MonthName>January</MonthName>
  </MonthlyDetails>
</ProductFeedStockDetails>

```

Note: The code excerpt above is presented here to demonstrate the concept of reporting greenhouse gas emissions data.

Figure 19
Product and Feedstock Monthly Details Schema Diagram

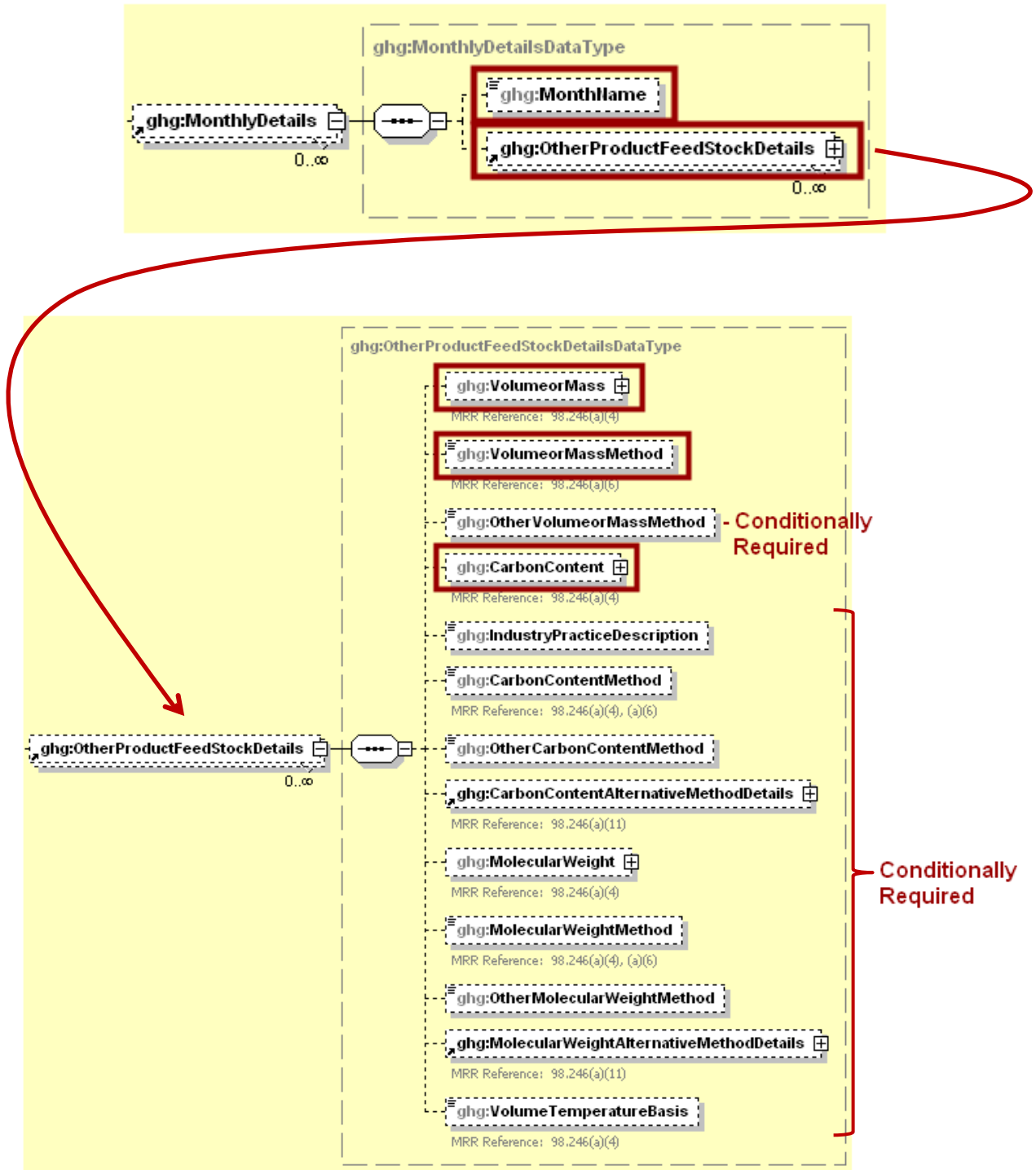

Note: Data elements boxed in red are required. Please see page 4 of this document for more information on conditionally required elements.

For each process unit and for each solid, liquid, and gaseous carbon-containing feedstock or product the system and for each month, report the following:

- An indication as to whether the volume (gaseous and liquid) or mass (solid, liquid, or gas) was based on a missing data procedure described in 98.245 [98.3(c) (8)].
- Identification of each method used to measure volume or mass [98.246(a) (6)].
- An indication as to whether the carbon content or composition was based on a missing data procedure described in 98.245 [98.3(c) (8)].
- **Conditionally Required:** If the method used to determine the carbon content or composition is the industry standard practice for carbon black, specify the practice.
- **Conditionally Required:** The method used to determine the carbon content or composition [98.246(a) (4) and 98.246(a) (6)]. **Note:** Do not report this data element if you complied with the alternative sampling and analysis option in 98.243(c) (4) for the specified feedstock or product.

Conditionally Required: For each process unit and for each solid, liquid, and gaseous carbon-containing feedstock or product for which the facility specified that the carbon content or composition was determined using the 98.244(b) (4) (xv) (B) alternative method, report the following:

- The name or title of the method [98.246(a) (11) (I)].
- An explanation of why an alternative to the methods listed in 98.244(b) (4) (I) through (xiii) was needed [98.246(a) (11) (iii)].
- The filename of the copy of the alternative method. Include a copy of the method in Word or PDF format in the ZIP file uploaded to e-GGRT [98.246(a) (11) (ii)].

Figure 20
Carbon Content Alternative Method Details Schema Diagram

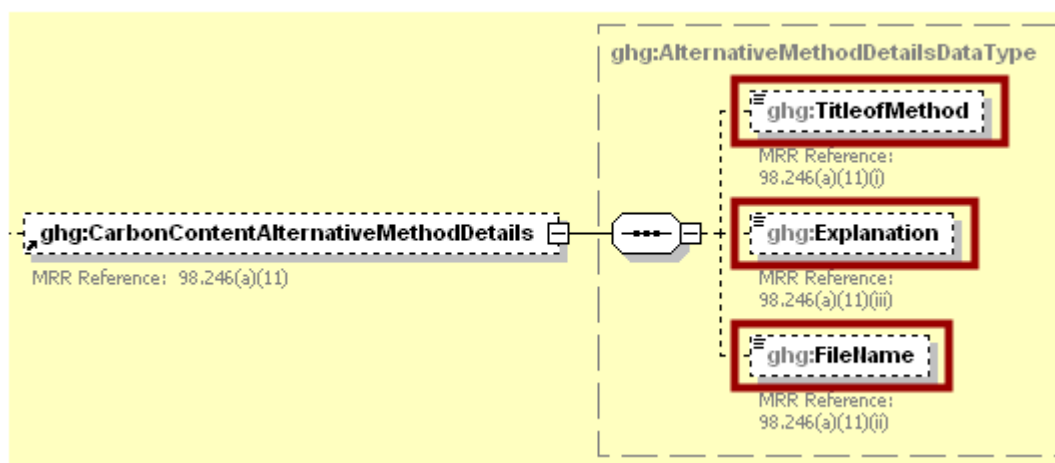

Conditionally Required: For each process unit and for each gaseous carbon-containing feedstock or product and for each month, report the following:

- An indication as to whether the molecular weight was based on a missing data procedure described in 98.245 [98.3(c) (8)].
- The method used to determine the molecular weight [98.246(a) (4) and 98.246(a) (6)].

Conditionally Required: For each process unit and for each gaseous carbon-containing feedstock or product for which the facility specified that the molecular weight was determined using the 98.244(b) (4) (xv) (B) alternative method, report the following:

- The name or title of the method [98.246(a) (11) (I)].
- An explanation of why an alternative to the methods listed in 98.244(b) (4) (I) through (xiii) was needed [98.246(a) (11) (iii)].
- The filename of the copy of the alternative method. Include a copy of the method in Word or PDF format in the ZIP file uploaded to e-GGRT [98.246(a) (11) (ii)].

Figure 21
Molecular Weight Alternative Method Details Schema Diagram

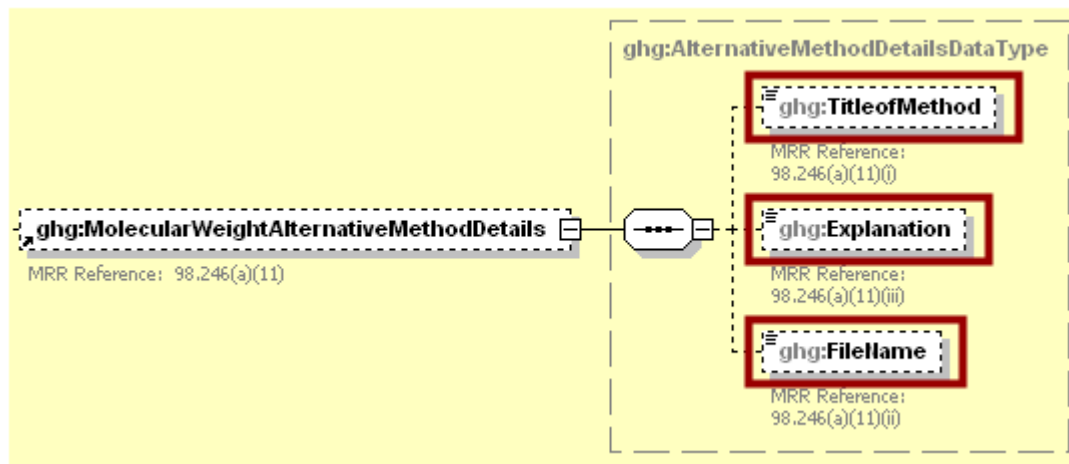

Conditionally Required: For each process unit and for each gaseous carbon-containing feedstock or product and for each month, report whether volume was measured at 60 degrees Fahrenheit or 68 degrees Fahrenheit [98.246(a) (4)] if the measurement of the feedstock or product quantity is volume-based.

Table 12
Product and Feedstock Monthly Details Data Element Definitions

Data Element Name	Description
MonthlyDetails	Parent Element: A collection of data elements which must be reported on a monthly basis. Report data for each month separately.
MonthName	Month name. For each product or feedstock each month may only be reported once. See list of allowable values: January February March April May June July August September October November December

Data Element Name	Description
OtherProductFeedStockDetails	Parent Element: A collection of data elements containing additional information on the specified feedstock or product.
VolumeorMass	Indicate (Y/N) whether the volume (gaseous and liquid) or mass (solid or liquid) for the feedstock or product and month specified was based on a missing data procedure described in 98.245.
VolumeorMassMethod	Report the method used to measure volume or mass. Report "Flow meter" for gaseous, "Weighing device" for solid, and any of the options for liquid feedstock or product. See list of allowable values: Flow meter Tank level measurements Weighing device Other (specify)
OtherVolumeorMassMethod	Conditionally Required: Report the method used to measure volume or mass if "Other (specify)" was reported above.
CarbonContent	Indicate (Y/N) whether the carbon content or composition for the feedstock or product and month specified was based on a missing data procedure described in 98.245. Report "N" if you used the alternative sampling and analysis option in 98.243(c) (4).
IndustryPracticeDescription	Conditionally Required: If you report CarbonContentMethod (below) as "Industry standard practice for carbon black", specify the practice.
CarbonContentMethod	Conditionally Required: Report the method listed in 98.244 used to determine the carbon content. See list of allowable values: ASTM D1945-03 ASTM D6060-96 (Reapproved 2001) ASTM D2505-88 (Reapproved 2004) ASTM UOP539-97 ASTM D3176-89 (Reapproved 2002) ASTM D5291-02 (Reapproved 2007) ASTM D5373-08 SW-846 Method 8015C SW-846 Method 8021B SW-846 Method 8031 SW-846 Method 9060A Method 18, 40 CFR 60, appendix A-6 Performance Spec 9, 40 CFR 60, App B ASTM D2593-93 (Reapproved 2009) ASTM D7633-10 Chromatographic analysis Mass spectrometer analysis Industry standard practice for carbon black 98.244(b)(4)(xv)(B) alternative method Other (specify) Note: Do not report this data element if you complied with the alternative sampling and analysis option in 98.243(c) (4) for the specified feedstock.

Data Element Name	Description
OtherCarbonContentMethod	Conditionally Required: Report the method used to determine the carbon content if “Other (specify)” was reported above.
CarbonContentAlternativeMethodDetails	Parent Element (Conditionally Required): A collection of data elements to report if CarbonContentMethod is "98.244(b) (4) (xv) (B) alternative method".
TitleofMethod	Name or title of the carbon content determination alternative method.
Explanation	An explanation of why an alternative to the methods listed in 98.244(b) (4) (I) through (xiv) was needed.
FileName	File name of the copy of the alternative method. If the method is a modification of a method listed in 98.244(b) (4) (I) through (xiv), you may provide a copy of only the sections that differ from the listed method. Include a copy of the file in Word or PDF format in the ZIP file uploaded to e-GGRT.
MolecularWeight	Conditionally Required: If the specified feedstock or product is gaseous, an indication (Y/N) as to whether the molecular weight was based on a missing data procedure described in 98.245. Note: Measurement of the molecular weight of the feedstock stream (i.e., the average molecular weight) is not needed if you measure the composition. In such cases, use the known molecular weights of the identified compounds in the stream, and report “N” for this data element.
MolecularWeightMethod	Conditionally Required: If the specified feedstock or product is gaseous and only if the quantity is measured as volume, not mass, report the name of the method used to determine the molecular weight. See list of allowable values: Calculated based on chemical formula and atomic weights 98.244(b)(4)(xv)(B) alternative method Other (specify)
OtherMolecularWeightMethod	Conditionally Required: If the specified feedstock or product is gaseous, report the name of the method used to determine the molecular weight if “Other (specify)” was reported above.
MolecularWeightAlternativeMethodDetails	Parent Element (Conditionally Required): A collection of data elements to report if MolecularWeightMethod is "98.244(b) (4) (xv) (B) alternative method".
TitleofMethod	The name or title of the molecular weight alternative method.
Explanation	An explanation of why an alternative method was needed.
FileName	File name of the copy of the alternative method. Include a copy of the file in Word or PDF format in the ZIP file uploaded to e-GGRT.

Data Element Name	Description
VolumeTemperatureBasis	<p>Conditionally Required: If the specified feedstock or product is gaseous and only if the quantity is measured as volume, not the mass, the temperature at which the gaseous feedstock or product volume was measured. See list of allowable values:</p> <p>60 degrees Fahrenheit 68 degrees Fahrenheit</p>

XML Excerpt 9 Example for Product and Feedstock Monthly Details

```

<ghg:MonthlyDetails>
  <ghg:MonthName>January</ghg:MonthName>
  <ghg:OtherProductFeedStockDetails>
    <ghg:VolumeorMass>
      <ghg:IsSubstitutedIndicator>Y</ghg:IsSubstitutedIndicator>
    </ghg:VolumeorMass>
    <ghg:VolumeorMassMethod>Flow meter</ghg:VolumeorMassMethod>
    <ghg:CarbonContent>
      <ghg:IsSubstitutedIndicator>N</ghg:IsSubstitutedIndicator>
    </ghg:CarbonContent>
    <ghg:CarbonContentMethod>Chromatographic analysis</ghg:CarbonContentMethod>
    <ghg:MolecularWeight>
      <ghg:IsSubstitutedIndicator>N</ghg:IsSubstitutedIndicator>
    </ghg:MolecularWeight>
    <ghg:MolecularWeightMethod>Calculated based on chemical formula and atomic
weights</ghg:MolecularWeightMethod>
    <ghg:VolumeTemperatureBasis>60 degrees Fahrenheit</ghg:VolumeTemperatureBasis>
  </ghg:OtherProductFeedStockDetails>
</ghg:MonthlyDetails>
<ghg:MonthlyDetails>
  <ghg:MonthName>February</ghg:MonthName>
  <ghg:OtherProductFeedStockDetails>
    <ghg:VolumeorMass>
      <ghg:IsSubstitutedIndicator>N</ghg:IsSubstitutedIndicator>
    </ghg:VolumeorMass>
    <ghg:VolumeorMassMethod>Flow meter</ghg:VolumeorMassMethod>
    <ghg:CarbonContent>
      <ghg:IsSubstitutedIndicator>N</ghg:IsSubstitutedIndicator>
    </ghg:CarbonContent>
    <ghg:CarbonContentMethod>Chromatographic analysis</ghg:CarbonContentMethod>
    <ghg:MolecularWeight>
      <ghg:IsSubstitutedIndicator>N</ghg:IsSubstitutedIndicator>
    </ghg:MolecularWeight>
    <ghg:MolecularWeightMethod>Calculated based on chemical formula and atomic
weights</ghg:MolecularWeightMethod>
    <ghg:VolumeTemperatureBasis>60 degrees Fahrenheit</ghg:VolumeTemperatureBasis>
  </ghg:OtherProductFeedStockDetails>
</ghg:MonthlyDetails>

```

Note: The code excerpt above is presented here to demonstrate the concept of reporting greenhouse gas emissions data.

**Figure 22
Additional Details Schema Diagram**

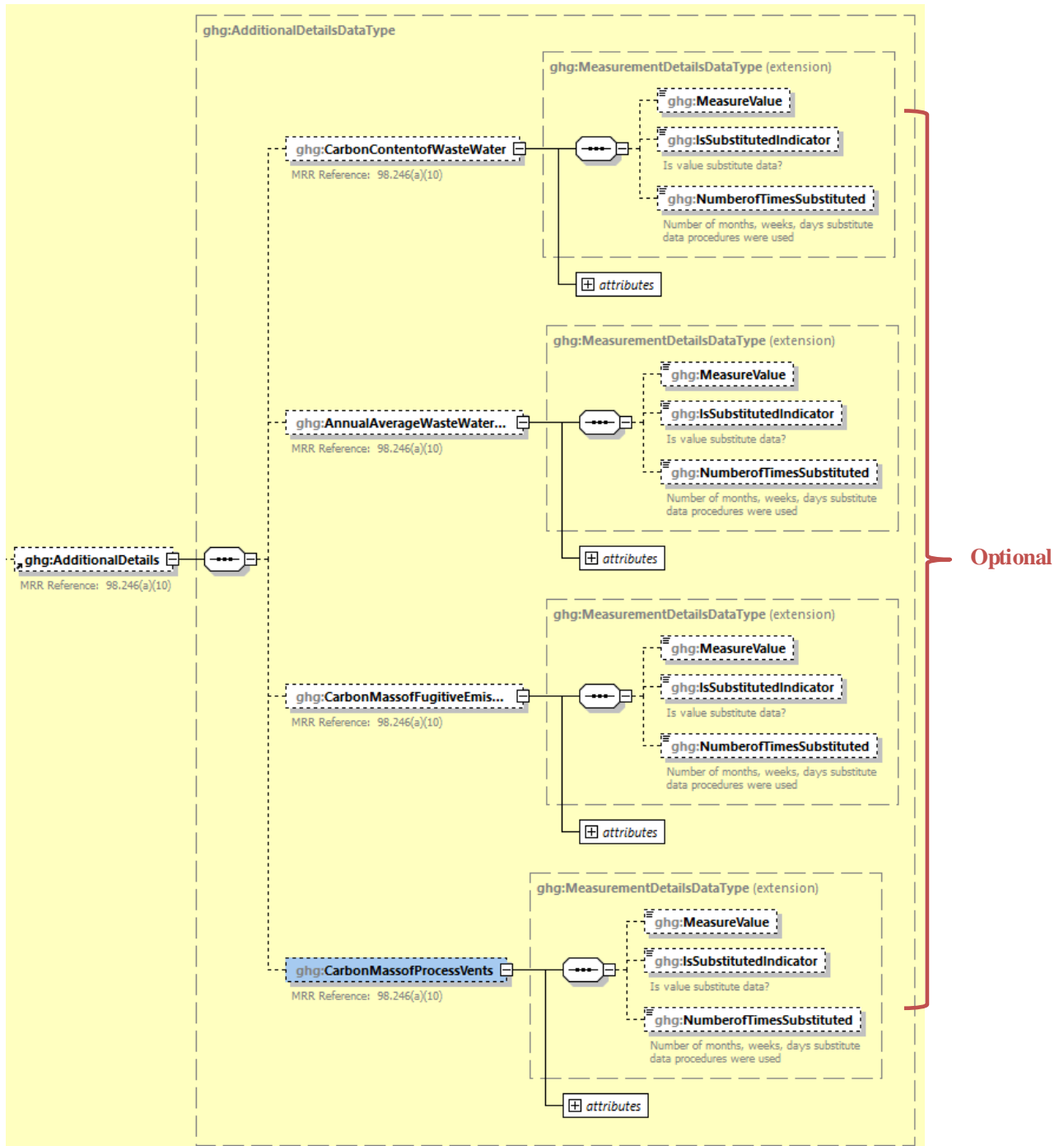

Note: Data elements boxed in red are required. Please see page 4 of this document for more information on conditionally required elements.

The facility has the option of reporting the following wastewater information for each petrochemical process unit:

- The annual average carbon content of the wastewater [98.246(a) (10)].
- The total annual flow of wastewater [98.246(a) (10)].
- The unit of measure for the total annual flow of wastewater [98.246(a) (10)].

The facility has the option of reporting the following unburned carbon releases information for each petrochemical process unit:

- Annual mass of carbon released in fugitive emissions not controlled with a combustion device [98.246(a) (10)].
- Annual mass of carbon released in process vents not controlled with a combustion device [98.246(a) (10)].

Table 13
Additional Details Data Element Definitions

Data Element Name	Description
AdditionalDetails	Parent Element (Optional): A collection of optional data elements to report with additional details about the specified petrochemical process unit.
CarbonContentofWasteWater	Optional: A collection of data elements containing the annual average carbon content of the wastewater. You may elect to report this data element if you also elect to report the data element “AnnualAverageWasteWaterFlow”. If so, report the value in the child data element MeasureValue . Set the units of measure to “decimal fraction” in the attribute fractionUOM .
AnnualAverageWasteWaterFlow	Optional: A collection of data elements containing the total annual flow of wastewater. You may elect to report this data element if you also elect to report the data element “CarbonContentofWasteWater”. If so, report the value in the child data element MeasureValue . Set the units of measure to “kg” or “gal” in the attribute UnitsofMeasure .
CarbonMassofFugitiveEmissions	Optional: A collection of data elements containing the annual mass of carbon released in fugitive emissions that are not controlled with a combustion device. You may elect to report this data element. If so, report the value in the child data element MeasureValue . Set the units of measure to “Metric Tons” in the attribute massUOM .
CarbonMassofProcessVents	Optional: A collection of data elements containing the annual mass of carbon released in process vents that are not controlled with a combustion device. You may elect to report this data element. If so, report the value in the child data element MeasureValue . Set the units of measure to “Metric Tons” in the attribute massUOM .

XML Excerpt 10 Example for Additional Details

```
<ghg:AdditionalDetails>  
  <ghg:CarbonContentofWasteWater fractionUOM="decimal fraction">  
    <ghg:MeasureValue>0.02</ghg:MeasureValue>  
  </ghg:CarbonContentofWasteWater>  
  <ghg:AnnualAverageWasteWaterFlow UnitsOfMeasure="kg">  
    <ghg:MeasureValue>3000</ghg:MeasureValue>  
  </ghg:AnnualAverageWasteWaterFlow>  
  <ghg:CarbonMassofFugitiveEmissions massUOM="Metric Tons">  
    <ghg:MeasureValue>4000</ghg:MeasureValue>  
  </ghg:CarbonMassofFugitiveEmissions>  
  <ghg:CarbonMassofProcessVents massUOM="Metric Tons">  
    <ghg:MeasureValue>5000</ghg:MeasureValue>  
  </ghg:CarbonMassofProcessVents>  
</ghg:AdditionalDetails>  
</ghg:MassBalanceDetails>
```

Note: The code excerpt above is presented here to demonstrate the concept of reporting greenhouse gas emissions data.

4.0 Ethylene Combustion Methodology Details

Conditionally Required: This section describes information which must be reported for each petrochemical process unit for which the combustion methodology for ethylene production processes of 98.243(d) was used. This method may be used as an alternative to the mass balance option if some process vent emissions and/or emissions from combustion of process off-gas are not routed to a stack that is monitored with CEMS (except flare stacks) to measure CO₂ emissions and the unit is producing ethylene. Note that the combustion methodology for ethylene production is only an option for process units that produce ethylene.

Figure 23
Ethylene Combustion Methodology Schema Diagram

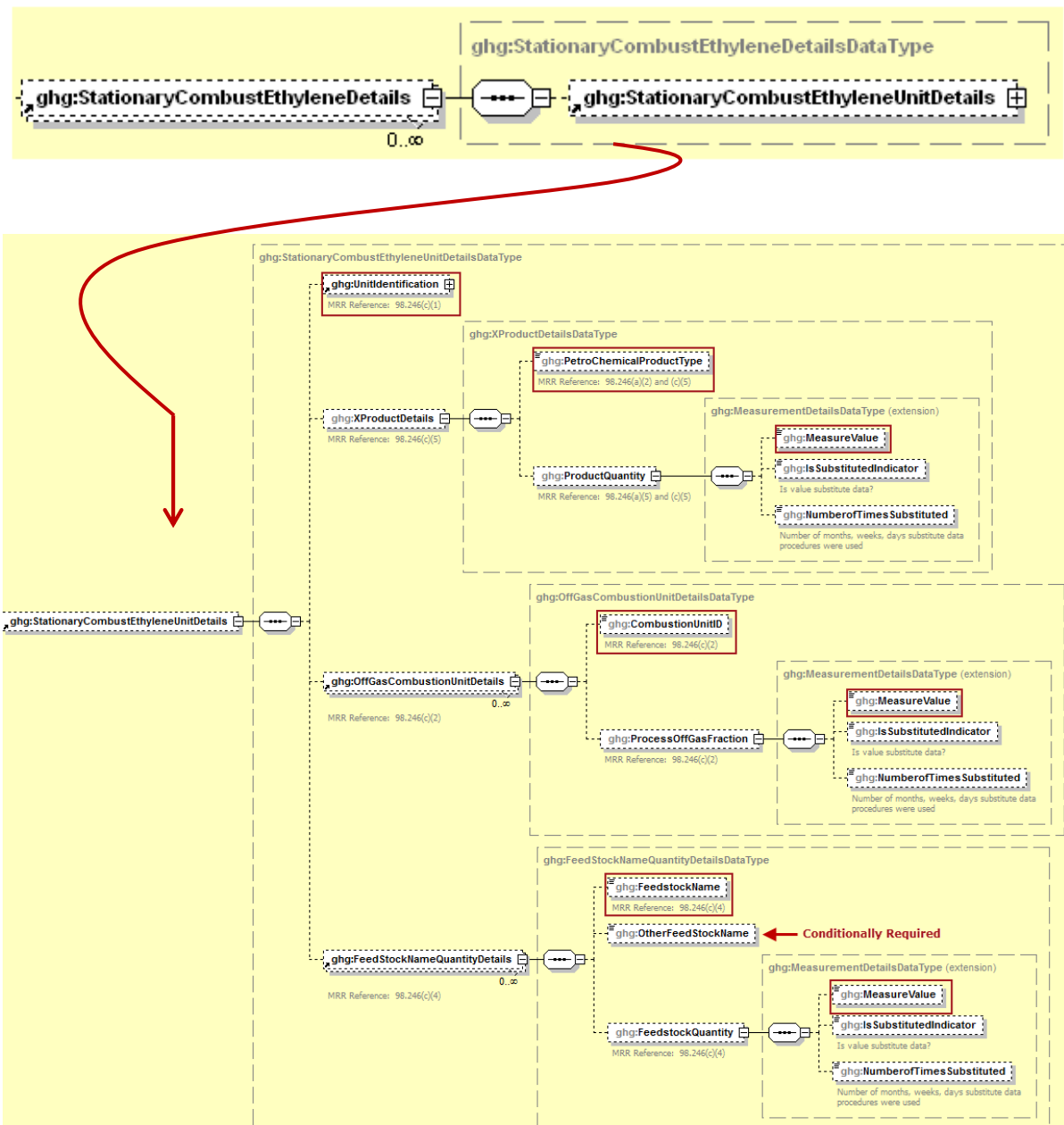

Note: Data elements boxed in red are required. Please see page 4 of this document for more information on conditionally required elements.

The facility is required to provide the following for each petrochemical process unit for which the facility specified the ethylene combustion methodology:

- A unique name/identifier [98.246(c) (1)].
- An optional description of the process unit [98.246(c) (1)].
- The unit type: "Petrochemical process unit".
- The type of petrochemical produced: "Ethylene"
- The annual quantity of ethylene produced [98.246 (c) (5)].
- The unit name or identifier of each Subpart C stationary combustion configuration that burns process off-gas from the ethylene process unit [98.246(c) (2)].
- For each Subpart C stationary combustion configuration that burns process off-gas from the ethylene process unit, provide an estimate of the fraction of the configuration's total emissions attributable to combustion of process off-gas from the ethylene process unit [98.246(c)(2)].
- The type of each carbon-containing feedstock fed to the ethylene process unit [98.246(c) (4)].
- The annual quantity of each type of carbon-containing feedstock fed to the ethylene process unit [98.246(c) (4)].

Table 14
Ethylene Combustion Methodology Data Element Definitions

Data Element Name	Description
StationaryCombustEthyleneDetails	Parent Element (Conditionally Required): A collection of data elements containing information on units for which the optional combustion methodology for ethylene production processes was used to monitor emissions. Report data for each unit separately.
StationaryCombustEthyleneUnitDetails	Parent Element: A collection of data elements containing information on each unit for which the optional combustion methodology for ethylene production processes was used to monitor emissions.
UnitIdentification	A collection of data elements containing the identity of each petrochemical process unit. Report a unique unit name (ID) in the child data element UnitName , an optional brief description in the child data element UnitDescription and the type of unit in the child data element UnitType : "Petrochemical process unit". Within the facility UnitName must be unique.
XProductDetails	Parent Element: A collection of data elements containing information about the petrochemical produced by the specified unit.
PetroChemicalProductType	The type of petrochemical produced: Ethylene
ProductQuantity	A collection of data elements containing information on the annual quantity of ethylene produced by the specified unit. Report the value in the child data element MeasureValue . Set the units of measure to "Metric Tons" in the attribute massUOM .
OffGas CombustionUnitDetails	Parent Element: A collection of data elements containing information about each stationary combustion configuration that burns off-gas from the specified ethylene process unit.

Data Element Name	Description
CombustionUnitID	The unit name or identifier of each Subpart C stationary combustion configuration that burns process off-gas from the specified ethylene process unit.
ProcessOffGasFraction	A collection of data elements containing information on the fraction of the total emissions from the specified configuration that is attributable to combustion of off-gas from the specified ethylene process unit. Report the value in the child data element MeasureValue . Set the units of measure to “decimal fraction” in the attribute fractionUOM .
FeedStockNameQuantityDetails	Parent Element: A collection of data elements containing information on each carbon-containing feedstock fed to the specified ethylene process unit.
FeedstockName	<p>The name of the carbon-containing feedstock fed to the specified ethylene process unit. See list of allowable values. If the name of the feedstock you are reporting does not appear in the list, then specify "Other" and report its name in the "OtherFeedStockName" data element.</p> <p>Propane Ethane Butane Naphtha Gas oil Natural Gas Liquids Other</p>
OtherFeedStockName	Conditionally Required: The name of carbon-containing feedstock fed to the specified ethylene process unit if "Other" was specified.
FeedstockQuantity	A collection of data elements containing information on the annual quantity of the carbon-containing feedstock fed to the specified ethylene process unit. Report the value in the child data element MeasureValue . Set the units of measure to “Metric Tons” in the attribute massUOM .

XML Excerpt 11 Example for Ethylene Combustion Methodology

```

<ghg:StationaryCombustEthyleneDetails >
  <ghg:StationaryCombustEthyleneUnitDetails >
    <ghg:UnitIdentification >
      <ghg:UnitName >003- Ethylene</ghg:UnitName >
      <ghg:UnitDescription >Ethylene unit</ghg:UnitDescription >
      <ghg:UnitType >Petrochemical process unit</ghg:UnitType >
    </ghg:UnitIdentification >
    <ghg:XProductDetails >
      <ghg:PetroChemicalProductType >Ethylene</ghg:PetroChemicalProductType >
      <ghg:ProductQuantity massUOM="Metric Tons" >
        <ghg:MeasureValue >8000</ghg:MeasureValue >
      </ghg:ProductQuantity >
    </ghg:XProductDetails >
    <ghg:OffGasCombustionUnitDetails >
      <ghg:CombustionUnitID >Unit C-1</ghg:CombustionUnitID >
      <ghg:ProcessOffGasFraction fractionUOM="decimal fraction" >
        <ghg:MeasureValue >0.15</ghg:MeasureValue >
      </ghg:ProcessOffGasFraction >
    </ghg:OffGasCombustionUnitDetails >
    <ghg:FeedStockNameQuantityDetails >
      <ghg:FeedstockName >Ethane</ghg:FeedstockName >
      <ghg:FeedstockQuantity massUOM="Metric Tons" >
        <ghg:MeasureValue >100</ghg:MeasureValue >
      </ghg:FeedstockQuantity >
    </ghg:FeedStockNameQuantityDetails >
  </ghg:StationaryCombustEthyleneUnitDetails >
</ghg:StationaryCombustEthyleneDetails >

```

Note: The code excerpt above is presented here to demonstrate the concept of reporting greenhouse gas emissions data.

5.0 Flare Gas Details

Conditionally Required: If your facility elects to use the CEMS methodology or the combustion methodology for ethylene production processes for one or more petrochemical process units, then information for each flare that burns process off-gas must be reported.

**Figure 24
Flare Gas Details Schema Diagram**

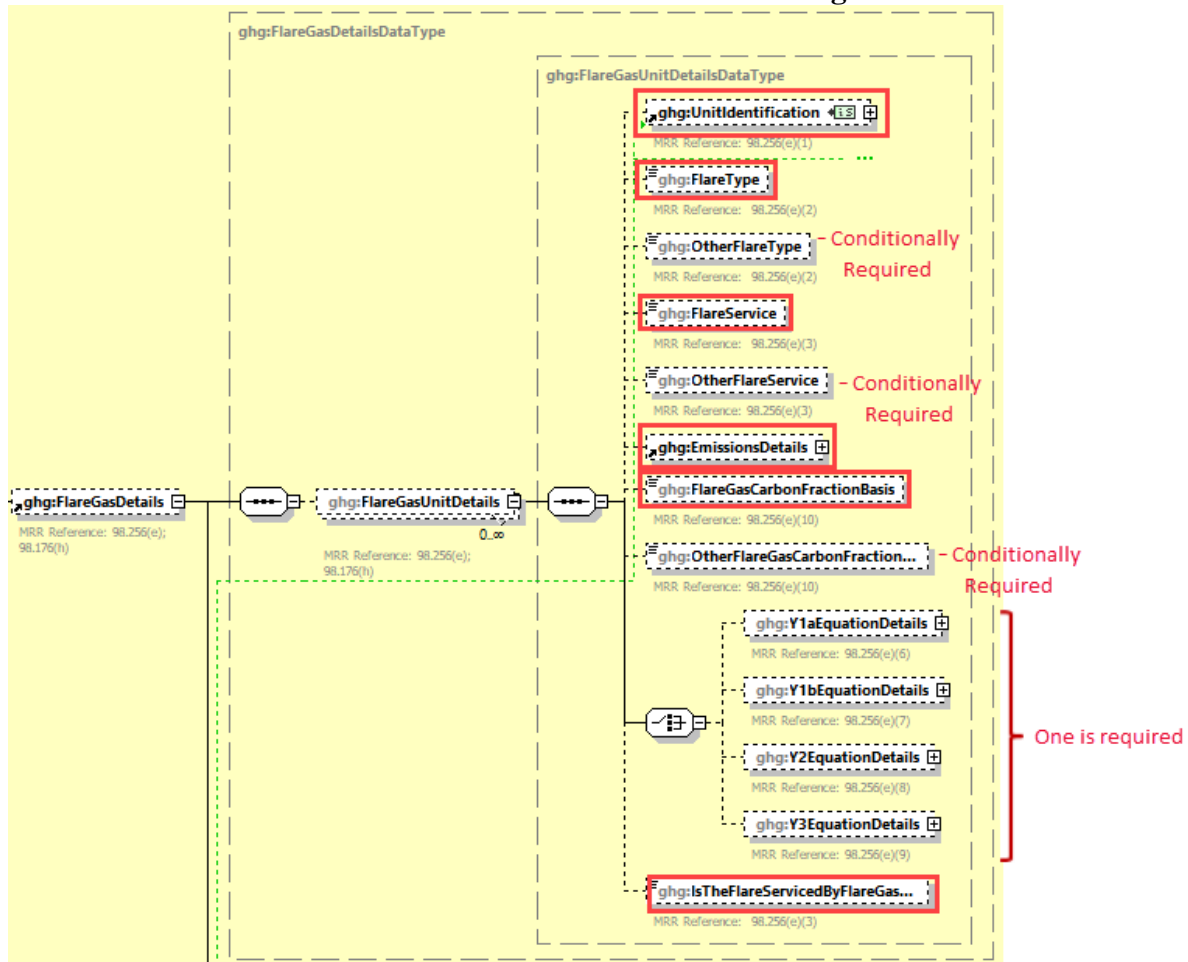

For each flare, the facility is required to report the following:

- A unique identifier/description [98.256(e) (1)].
- The type of flare [98.256(e) (2)].
- The flare service type [98.256(e) (3)].

Figure 25
Flare Gas Unit Details Schema Diagram

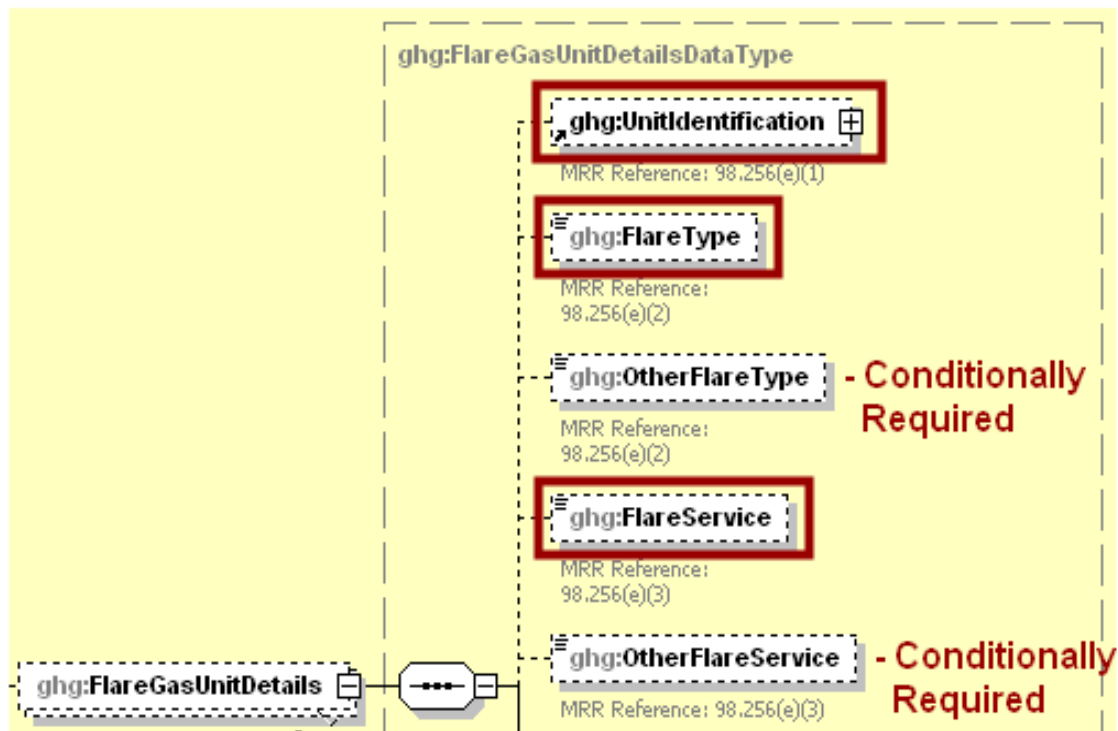

Note: Data elements boxed in red are required. Please see page 4 of this document for more information on conditionally required elements.

Table 15
Flare Gas Unit Details Data Element Definitions

Data Element Name	Description
FlareGasDetails	Parent Element (Conditionally Required): A collection of data elements containing details about emissions from each flare that burns process off-gas if using CEMS or the ethylene combustion methodology.
FlareGasUnitDetails	Parent Element: A collection of data elements containing details for a specific flare.
UnitIdentification	A collection of data elements containing the identity of each flare. Report a unique unit name (ID) in the child data element UnitName , an optional brief description in the child data element UnitDescription and the type of unit in the child data element UnitType : "Flare".
FlareType	Type of flare. See list of allowable values: Steam assisted Air-assisted Unassisted Other (specify)

Data Element Name	Description
OtherFlareType	Conditionally Required: Specify the type of flare if "Other (specify)" is reported for FlareType.
FlareService	The type of flare service. See list of allowable values: General facility flare Unit flare Emergency only flare Back-up flare Other (specify)
OtherFlareService	Conditionally Required: Specify the flare service if "Other (specify)" is reported for FlareService.

XML Excerpt 12 Example for Flare Gas Unit Details

```

<FlareGasDetails>
  <FlareGasUnitDetails>
    <UnitIdentification>
      <UnitName>Y-1a</UnitName>
      <UnitType>Flare</UnitType>
    </UnitIdentification>
    <FlareType>Steam assisted</FlareType>
    <FlareService>General facility flare</FlareService>
    <EmissionsDetails><ghg:FlareService>Back-up are</ghg:FlareService>
  </EmissionsDetails>

```

Note: The code excerpt above is presented here to demonstrate the concept of reporting greenhouse gas emissions data.

Figure 26
Flare Gas Unit Emissions and Carbon Fraction Basis Schema Diagram

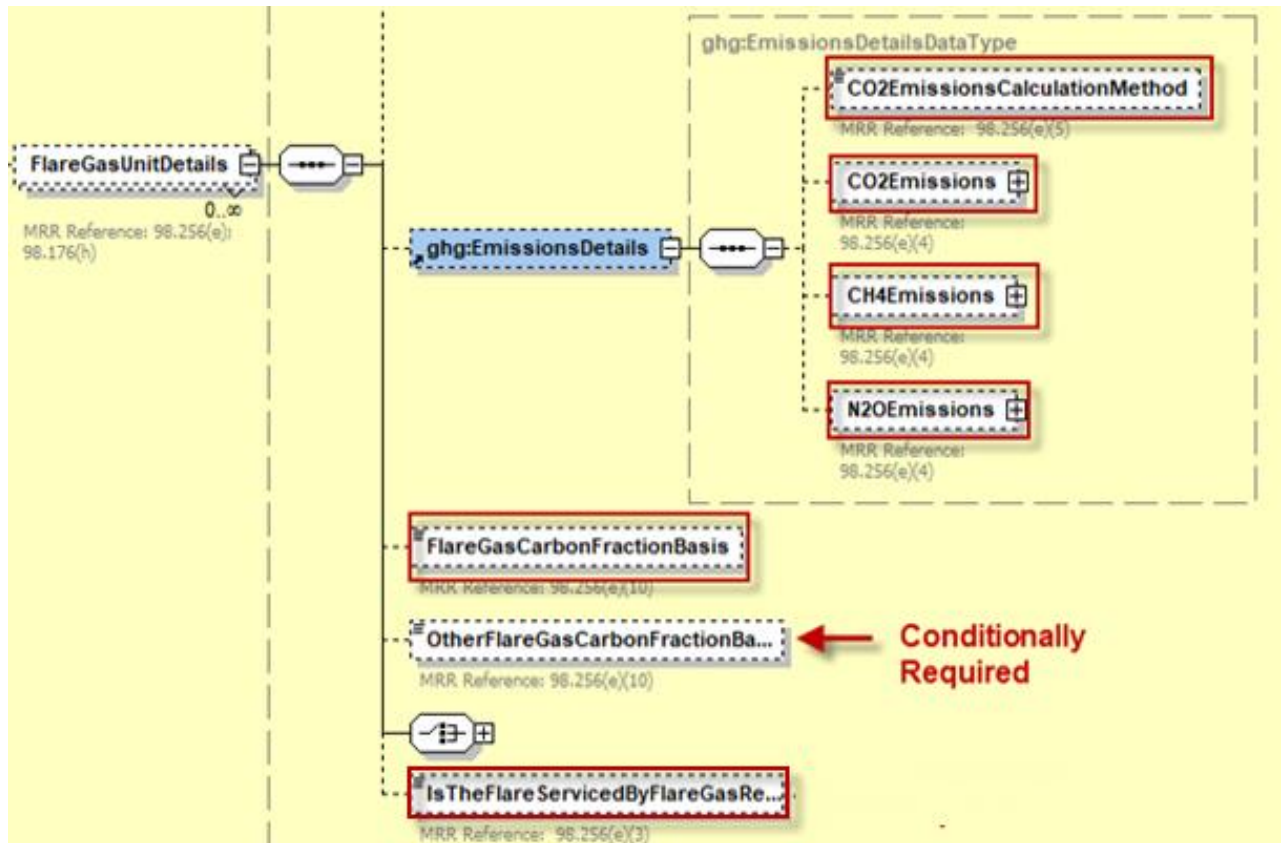

Note: Data elements boxed in red are required. Please see page 4 of this document for more information on conditionally required elements.

For each flare, the facility is required to report the following:

- The method used to calculate the CO₂ emissions (e.g., reference section and equation number) [98.256(e) (5)].
- Estimated CO₂ emissions [98.256(e) (4)].
- Estimated CH₄ emissions [98.256(e) (4)].
- Estimated N₂O emissions [98.256(e) (4)].
- The basis for the fraction of carbon in the flare gas contributed by methane value [98.256(e) (10)].
- If the flare is serviced by a gas recovery system [98.256(e) (3)].

Table 16
Flare Gas Unit Emissions and Carbon Fraction Basis Data Element Definitions

Data Element Name	Description
EmissionsDetails	Parent Element: A collection of data elements containing information on the calculated annual emissions for the specified flare.
CO2EmissionsCalculationMethod	The method used to calculate the CO ₂ emissions for the specified flare. See list of allowable values: 98.253(b)(1)(ii)(A) – Equation Y-1a – Gas Composition Monitored 98.253(b)(1)(ii)(A) – Equation Y-1b – Gas Composition Monitored 98.253(b)(1)(ii)(B) – Equation Y-2 – Heat Content Monitored 98.253(b)(1)(iii) – Equation Y-3 – Start-up, Shutdown, Malfunction
CO2Emissions	A collection of data elements containing information on the annual CO ₂ emissions for the specified flare. Report the value in the child data element CalculatedValue . Set the units of measure to “Metric Tons” in the attribute massUOM .
CH4Emissions	A collection of data elements containing information on the annual CH ₄ emissions for the specified flare (the output of Equation Y-4). Report the value in the child data element CalculatedValue . Set the units of measure to “Metric Tons” in the attribute massUOM .
N2OEmissions	A collection of data elements containing information on the annual N ₂ O emissions for the specified flare (the output of Equation Y-5). Report the value in the child data element CalculatedValue . Set the units of measure to “Metric Tons” in the attribute massUOM .
FlareGasCarbonFractionBasis	Basis for the fraction of carbon in the flare gas contributed by methane. See list of allowable values: Default Value Method 18 at 40 CFR part 60, appendix A-6 ASTM D1945-03 ASTM D1946-90 (Reapproved 2006) GPA 2261-00 UOP539-97 ASTM D2503-92 (Reapproved 2007) Chromatographic analysis: manufacturer’s instructions Engineering calculations Other (specify)

Data Element Name	Description
OtherFlareGasCarbonFractionBasis	Conditionally Required: Specify the basis for the fraction of carbon in the flare gas contributed by methane if "Other (specify)" is reported for FlareGasCarbonFractionBasis.
IsTheFlareServedByFlareGasRecovery	Required if this node is used: Indicate (Y or N) if the flare is serviced by a flare gas recovery system

XML Excerpt 13
Example for Flare Gas Unit Emissions and Carbon Fraction Basis

```

<EmissionsDetails>
  <CO2EmissionsCalculationMethod>98.253(b)(1)(ii)(A) - Equation Y-1a Gas Composition
Monitored</CO2EmissionsCalculationMethod>
  <CO2Emissions massUOM="Metric Tons">
    <CalculatedValue>8</CalculatedValue>
    <OverrideIndicator>N</OverrideIndicator>
  </CO2Emissions>
  <CH4Emissions massUOM="Metric Tons">
    <CalculatedValue>0.04</CalculatedValue>
    <OverrideIndicator>N</OverrideIndicator>
  </CH4Emissions>
  <N2OEmissions massUOM="Metric Tons">
    <CalculatedValue>0.000</CalculatedValue>
    <OverrideIndicator>N</OverrideIndicator>
  </N2OEmissions>
</EmissionsDetails>
<FlareGasCarbonFractionBasis>ASTM D2503-92 (Reapproved 2007)</FlareGasCarbonFractionBasis>
<IsTheFlareServedByFlareGasRecovery>N</IsTheFlareServedByFlareGasRecovery>
    
```

Note: The code excerpt above is presented here to demonstrate the concept of reporting greenhouse gas emissions data.

Figure 27
Equation Y-1a Details Schema Diagram

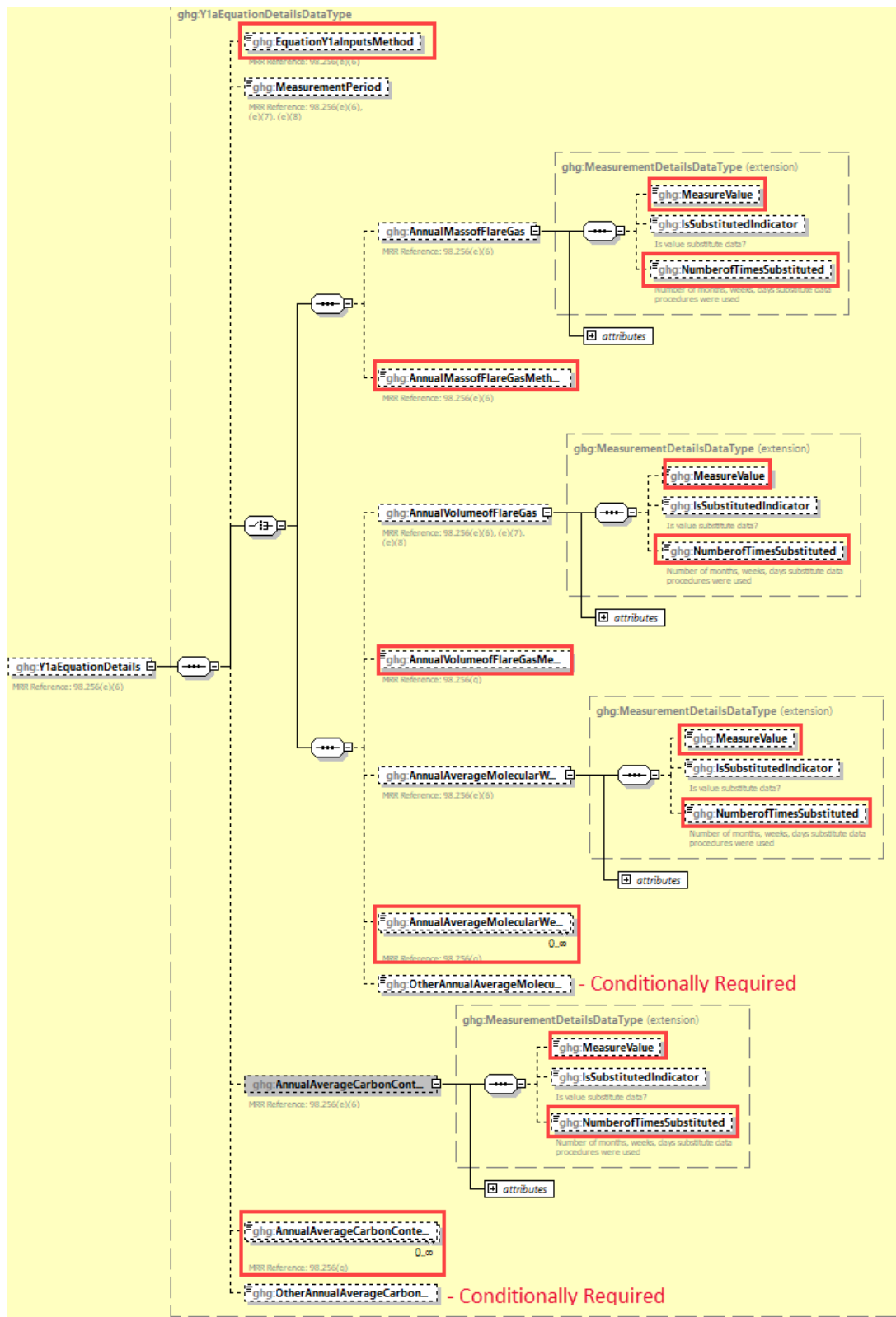

Note: Data elements boxed in red are required. Please see page 4 of this document for more information on conditionally required elements.

Conditionally Required: For each flare using the Equation Y-1a calculation method, the facility is required to report the following:

- An indication of whether daily or weekly measurement periods are used [98.256(e) (6)].
- The annual volume of flare gas combusted [98.256(e) (6)].
- The number of days missing data procedures were used to measure volume of flare gas combusted.
- Indicate the specific consensus-based standard method number or describe the procedure specified by the flow meter manufacturer used to measure the annual volume of flare gas combusted [98.256(q)].
- The annual average molecular weight [98.256(e) (6)].
- Number of days missing data procedures were used to measure the molecular weight.
- The method(s) used to measure annual average molecular weight [98.256(q)].
- Annual average carbon content of the flare gas [98.256(e) (6)].
- Number of days missing data procedures were used to measure carbon content of the flare gas.
- The method(s) used to measure carbon content of the flare gas [98.256(q)].

Table 17
Equation Y-1a Details Data Element Definitions

Data Element Name	Description
Y1aEquationDetails	Parent Element (Conditionally Required): A collection of data elements to report if Equation Y-1a was used to calculate the CO ₂ emissions for the specified flare.
EquationY1aInputMethods	Indicate the input method for Equation Y-1a. Allowable values include: Mass Basis or Volumetric Basis,
MeasurementPeriod	Frequency of measurement data. See list of allowable values: Daily Weekly
AnnualMassofFlareGas	Parent Element: A collection of data elements containing information on the annual mass of flare gas combusted.
MeasureValue	Measured value (decimal) of the annual mass of flare gas combusted.

Data Element Name	Description
NumberofTimesSubstituted	The number (integer) of days in the reporting year that missing data procedures were followed.
AnnualVolumeofFlareGas	Parent Element: A collection of data elements containing information on the annual volume of flare gas combusted.
Measure Value	Measured value (decimal) of the annual volume of flare gas combusted. Set the units of measure to “scf” in the attribute volUOM .
NumberofTimesSubstituted	The number (integer) of days in the reporting year that missing data procedures were followed.
AnnualVolumeofFlareGas Method	Specific consensus-based standard method number used to measure the volume of flare gas or describe the procedure specified by the flow meter manufacturer.
AnnualAverageMolecularWeight	Parent Element: A collection of data elements containing information on the annual average molecular weight of the flare gas.
Measure Value	Measured value (decimal) of the annual average molecular weight of the flare gas. Set the units of measure to “kg/kg-mole” in the attribute molewtUOM .
NumberofTimesSubstituted	The number (integer) of days in the reporting year that missing data procedures were followed.

Data Element Name	Description
AnnualAverageMolecularWeightMethod	<p>Report each method used to determine the annual average molecular weight of the flare gas. See the list of allowable values:</p> <p>Method 18 at 40 CFR part 60, appendix A-6 ASTM D1945-03 ASTM D1946-90 (Reapproved 2006) GPA 2261-00 UOP539-97 ASTM D2503-92 (Reapproved 2007) Chromatographic analysis: manufacturer’s instructions Other (specify)</p>
OtherAnnualAverageMolecularWeightMethod	<p>Conditionally Required: Report the method used to determine the annual average molecular weight of the flare gas if “Other (specify)” was reported above.</p>
AnnualAverageCarbonContent	<p>Parent Element: A collection of data elements containing information on the annual average carbon content of the flare gas.</p>
MeasureValue	<p>Measured value (decimal) of on the annual average carbon content of the flare gas. Set the units of measure to “decimal fraction; kg carbon/kg flare gas, or kgC/scf” in the attribute carboncontentUOM.</p>
NumberofTimesSubstituted	<p>The number (integer) of days in the reporting year that missing data procedures were followed.</p>
AnnualAverageCarbonContentMethod	<p>Report each method used to determine the annual average carbon content of the flare gas. See the list of allowable values:</p> <p>Method 18 at 40 CFR part 60, appendix A-6 ASTM D1945-03 ASTM D1946-90 (Reapproved 2006) GPA 2261-00 UOP539-97 ASTM D2503-92 (Reapproved 2007) Chromatographic analysis: manufacturer’s instructions Other (specify)</p>
OtherAnnualAverageCarbonContentMethod	<p>Conditionally Required: Report the method used to determine the annual average carbon content of the flare gas if “Other (specify)” was reported above.</p>

XML Excerpt 14 Example for Equation Y-1a Details

```
-<Y1aEquationDetails>  
<EquationY1aInputsMethod>Mass basis</EquationY1aInputsMethod>  
<MeasurementPeriod>Daily</MeasurementPeriod>  
-<AnnualMassofFlareGas massUOM="Kilograms">  
<MeasureValue>-1</MeasureValue>  
<NumberOfTimesSubstituted>367</NumberOfTimesSubstituted>  
</AnnualMassofFlareGas>  
<AnnualMassofFlareGasMethod>trff</AnnualMassofFlareGasMethod>  
-<AnnualAverageCarbonContent carboncontentUOM="decimal fraction; kg carbon/kg flare gas">  
<MeasureValue>0.8</MeasureValue>  
<NumberOfTimesSubstituted>88</NumberOfTimesSubstituted>  
</AnnualAverageCarbonContent>  
</Y1aEquationDetails>
```

Note: The code excerpt above is presented here to demonstrate the concept of reporting greenhouse gas emissions data.

Figure 28
Equation Y-1b Details Schema Diagram

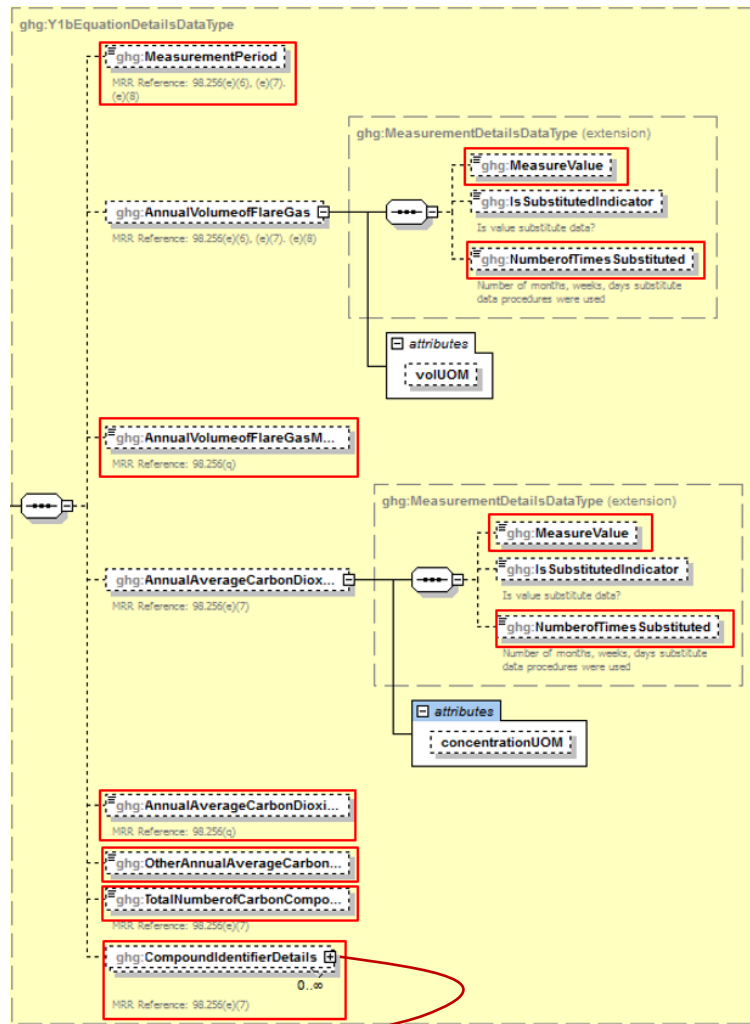
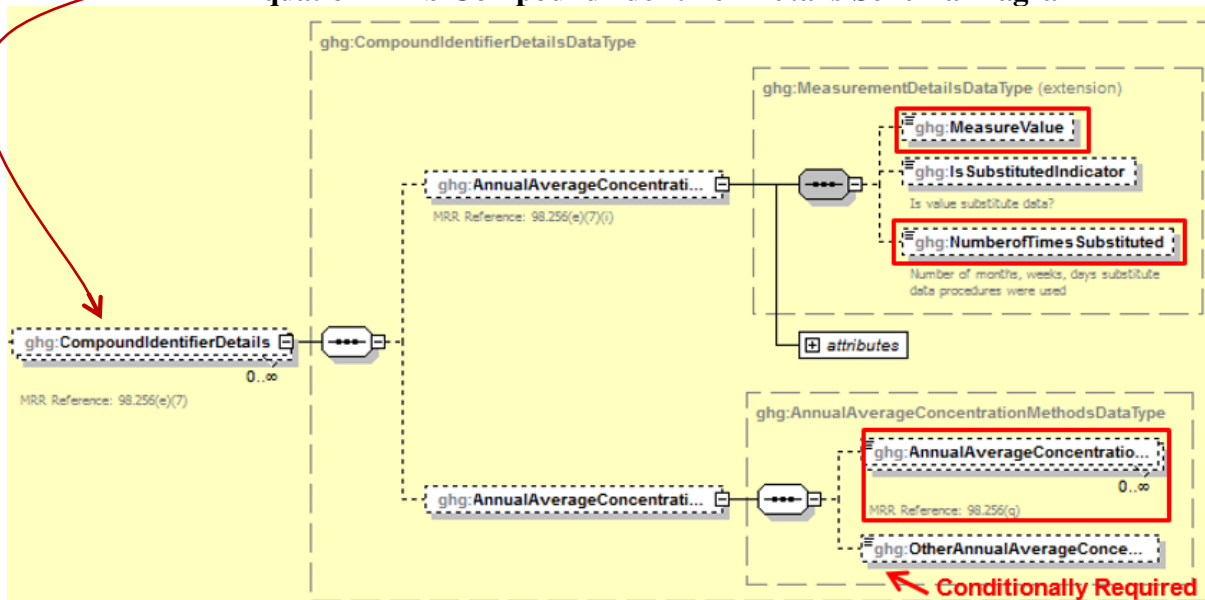

Figure 29
Equation Y-1b Compound Identifier Details Schema Diagram



Note: Data elements boxed in red are required. Please see page 4 of this document for more information on conditionally required elements.

Conditionally Required: For each flare using the Equation Y-1b calculation method, the facility is required to report the following:

- An indication of whether daily or weekly measurement periods are used [98.256(e) (7)].
- The annual volume of flare gas combusted [98.256(e) (7)].
- The number of days missing data procedures were used to determine the volume of flare gas combusted.
- Indicate the specific consensus-based standard method number or describe the procedure specified by the flow meter manufacturer [98.256(q)].
- The annual average CO₂ concentration [98.256(e) (7)].
- The number of days missing data procedures were used to determine CO₂ concentration.
- The method used to measure CO₂ concentration [98.256(q)].
- The total number of carbon containing compounds other than CO₂ that are in the flare gas stream [98.256(e) (7)].

For each carbon containing compound other than CO₂ in the flare gas stream identified by the facility, and for each flare using the Equation Y-1b, the facility must report the following:

- The annual average concentration of the compound [98.256(e) (7) (I)].
- Number of days missing data procedures were used to determine the concentration of the compound.
- The method(s) used to measure the concentration of the compound [98.256(q)].

Table 18
Equation Y-1b Details Data Element Definitions

Data Element Name	Description
Y1bEquationDetails	Parent Element (Conditionally Required): A collection of data elements to report if Equation Y-1b was used to calculate the CO ₂ emissions for the specified flare.
MeasurementPeriod	Frequency of measurement data. See list of allowable values: Daily Weekly
AnnualVolumeofFlareGas	Parent Element: A collection of data elements containing information on the annual volume of flare gas combusted.
MeasureValue	Measured value (decimal) of the annual volume of flare gas combusted. Set the units of measure to “scf” in the attribute volUOM .
NumberofTimesSubstituted	The number (integer) of days in the reporting year that missing data procedures were followed.
AnnualVolumeofFlareGasMethod	Specific consensus-based standard method number used to measure the volume of flare gas or describe the procedure specified by the flow meter manufacturer.

Data Element Name	Description
AnnualAverageCarbonDioxideConcentration	Parent Element: A collection of data elements containing information on the annual average CO ₂ content of the flare gas.
MeasureValue	Measured value (decimal) of the annual average CO ₂ content of the flare gas. Set the units of measure to “percent by volume or mole” in the attribute concentrationUOM .
NumberOfTimesSubstituted	The number (integer) of days in the reporting year that missing data procedures were followed.
AnnualAverageCarbonDioxideConcentrationMethod	The method used to determine the carbon dioxide concentration of the flare gas. See list of allowable values: Method 18 at 40 CFR part 60, appendix A-6 ASTM D1945-03 ASTM D1946-90 (Reapproved 2006) GPA 2261-00 UOP539-97 ASTM D2503-92 (Reapproved 2007) Chromatographic analysis: manufacturer’s instructions Other (specify)
OtherAnnualAverageCarbonDioxideConcentrationMethod	Conditionally Required: The method used to determine the carbon dioxide concentration of the flare gas if “Other (specify)” was reported above.
TotalNumberOfCarbonCompounds	The number of carbon containing compounds other than CO ₂ in the flare gas stream (integer).
CompoundIdentifierDetails	Parent Element: A collection of data elements to report for each carbon containing compound (other than CO ₂) in the flare gas stream.
AnnualAverageConcentration	Parent Element: A collection of data elements containing information on the annual average concentration of a specific carbon containing compound (other than CO ₂) in the flare gas stream for the specified flare
MeasureValue	Measured value (decimal) on the annual average concentration of a specific carbon containing compound (other than CO ₂) in the flare gas stream for the specified flare. Set the units of measure to “percent by volume or mole” in the attribute concentrationUOM .
NumberOfTimesSubstituted	The number (integer) of days in the reporting year that missing data procedures were followed.

Data Element Name	Description
AnnualAverageConcentrationMethods	Parent Element: A collection of data elements containing the method(s) used to determine the annual average concentration of the specific carbon containing compound (other than CO ₂).
AnnualAverageConcentrationMethod	Report each method used to determine the annual average concentration of the specific carbon containing compound (other than CO ₂). See list of allowable values: Method 18 at 40 CFR part 60, appendix A-6 ASTM D1945-03 ASTM D1946-90 (Reapproved 2006) GPA 2261-00 UOP539-97 ASTM D2503-92 (Reapproved 2007) Chromatographic analysis: manufacturer's instructions Other (specify)
OtherAnnualAverageConcentrationMethod	Conditionally Required: Report the method used to determine the annual average concentration of the specific carbon containing compound (other than CO ₂) if "Other (specify)" was reported above.

XML Excerpt 15 Example for Equation Y-1b Details

```

<Y1bEquationDetails>
  <MeasurementPeriod>Weekly</MeasurementPeriod>
  <AnnualVolumeofFlareGas volUOM="scf">
    <MeasureValue>8</MeasureValue>
    <NumberofTimesSubstituted>0</NumberofTimesSubstituted>
  </AnnualVolumeofFlareGas>
  <AnnualVolumeofFlareGasMethod>NONE</AnnualVolumeofFlareGasMethod>
  <AnnualAverageCarbonDioxideConcentration concentrationUOM="percent by volume or
mole">
    <MeasureValue>0.89</MeasureValue>
    <NumberofTimesSubstituted>2</NumberofTimesSubstituted>
  </AnnualAverageCarbonDioxideConcentration>
  <AnnualAverageCarbonDioxideConcentrationMethod>ASTM D1945-03
</AnnualAverageCarbonDioxideConcentrationMethod>
  <TotalNumberofCarbonCompounds>1</TotalNumberofCarbonCompounds>
  <CompoundIdentifierDetails>
    <AnnualAverageConcentration concentrationUOM="percent by volume or mole">
      <MeasureValue>0.500</MeasureValue>
      <NumberofTimesSubstituted>365</NumberofTimesSubstituted>
    </AnnualAverageConcentration>
    <AnnualAverageConcentrationMethods>
      <AnnualAverageConcentrationMethod>ASTM D1945-03
      </AnnualAverageConcentrationMethod>
    </AnnualAverageConcentrationMethods>
  </CompoundIdentifierDetails?
</Y1bEquationDetails>

```

Note: The code excerpt above is presented here to demonstrate the concept of reporting greenhouse gas emissions data.

Figure 30
Equation Y-2 Details Schema Diagram

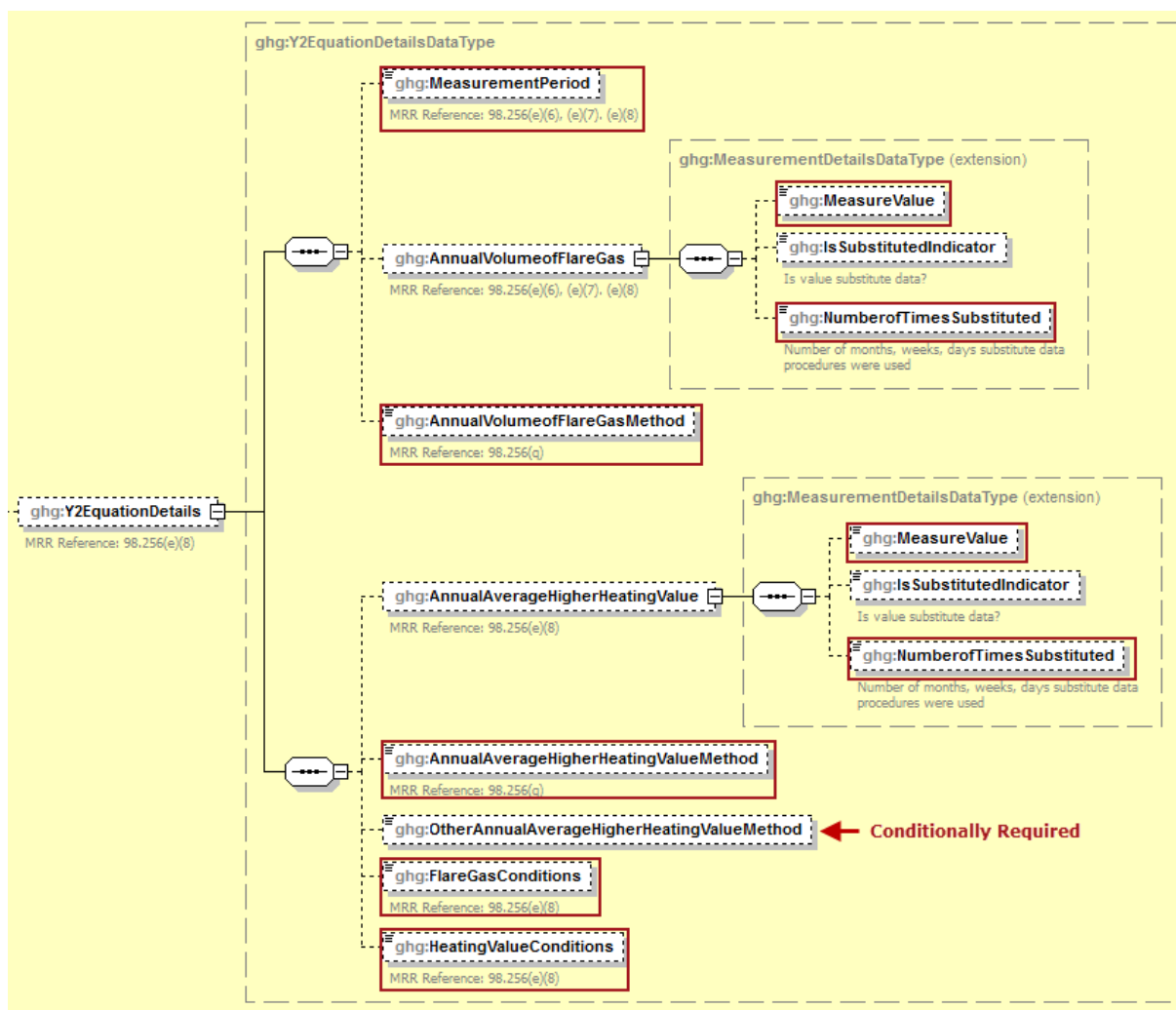

Note: Data elements boxed in red are required. Please see page 4 of this document for more information on conditionally required elements.

Conditionally Required: For each flare using the Equation Y-2 calculation method, the facility must identify the following:

- An indication of whether daily or weekly measurement periods are used [98.256(e) (8)].
- The annual volume of flare gas combusted [98.256(e) (8)].
- The number of days missing data procedures were used to determine the volume of flare gas combusted.
- The specific consensus-based standard method number or describe the procedure specified by the flow meter manufacturer [98.256(q)].
- The annual average higher heating value of the flare gas [98.256(e) (8)].
- The number of days missing data procedures were used to determine the annual average higher heating value of the flare gas.
- The method used to measure the annual average higher heating value of the flare gas [98.256(q)].
- An indication of whether the annual volume of flare gas combusted was determined using standard conditions of 68 °F and 14.7 psia or 60 °F and 14.7 psia [98.256(e)(8)].

- An indication of whether the annual average higher heating value of the flare gas was determined using standard conditions of 68 °F and 14.7 psia or 60 °F and 14.7 psia [98.256(e)(8)].

**Table 19
Equation Y-2 Details Data Element Definitions**

Data Element Name	Description
Y2EquationDetails	Parent Element (Conditionally Required): A collection of data elements to report if Equation Y-2 was used to calculate the CO ₂ emissions for the specified flare gas unit.
MeasurementPeriod	Frequency of measurement data. See list of allowable values: Daily Weekly
AnnualVolumeofFlareGas	Parent Element: A collection of data elements containing information on the annual volume of flare gas combusted.
MeasureValue	Measured value (decimal) of the annual volume of flare gas combusted. Set the units of measure to “MSc” in the attribute volUOM .
NumberofTimesSubstituted	The number (integer) of days in the reporting year that missing data procedures were followed.
AnnualVolumeofFlareGas Method	Specific consensus-based standard method number or describe the procedure specified by the flow meter manufacturer.
AnnualAverageHigherHeatingValue	Parent Element: A collection of data elements containing information on the annual average higher heating value of the flare gas.
MeasureValue	Measured value (decimal). Set the units of measure to “MMBtu/MSc” in the attribute heatUOM .
NumberofTimesSubstituted	The number (integer) of days in the reporting year that missing data procedures were followed.

Data Element Name	Description
AnnualAverageHigherHeatingValueMethod	The method used to determine the annual average higher heating value of the flare gas. See list of allowable values: ASTM D4809-06 ASTM D240-02 (Reapproved 2007) ASTM D1826-94 (Reapproved 2003) ASTM D3588-98 (Reapproved 2003) ASTM D4891-89 (Reapproved 2006) Chromatographic analysis: manufacturer’s instructions Other (specify)
OtherAnnualAverageHigherHeatingValueMethod	Conditionally Required: The method used to determine the annual average higher heating value of the flare gas if “Other (specify)” was reported above.
FlareGasConditions	Conditions at which the annual volume of flare gas was determined. See list of allowable values. 60 degrees F and 14.7 psia 68 degrees F and 14.7 psia
HeatingValueConditions	Conditions at which the annual average higher heating value was determined. See list of allowable values. 60 degrees F and 14.7 psia 68 degrees F and 14.7 psia

XML Excerpt 16 Example for Equation Y-2 Details

```

<MeasurementPeriod>Weekly</MeasurementPeriod>
<AnnualVolumeofFlareGas volUOM="MMscf">
  <MeasureValue>5</MeasureValue>
  <NumberOfTimesSubstituted>45</NumberOfTimesSubstituted>
</AnnualVolumeofFlareGas>
<AnnualVolumeofFlareGasMethod>NONE</AnnualVolumeofFlareGasMethod>
<AnnualAverageHigherHeatingValue heatUOM="MMBtu/MMscf">
  <MeasureValue>3</MeasureValue>
  <NumberOfTimesSubstituted>8</NumberOfTimesSubstituted>
</AnnualAverageHigherHeatingValue>
<AnnualAverageHigherHeatingValueMethod>Chromatographic analysis: manufacturer's
instructions</AnnualAverageHigherHeatingValueMethod>
<FlareGasConditions>68 degrees F and 14.7 psia</FlareGasConditions>
<HeatingValueConditions>60 degrees F and 14.7 psia</HeatingValueConditions>
</Y2EquationDetails>
    
```

Note: The code excerpt above is presented here to demonstrate the concept of reporting greenhouse gas emissions data.

Figure 31 Equation Y-3 Details Schema Diagram

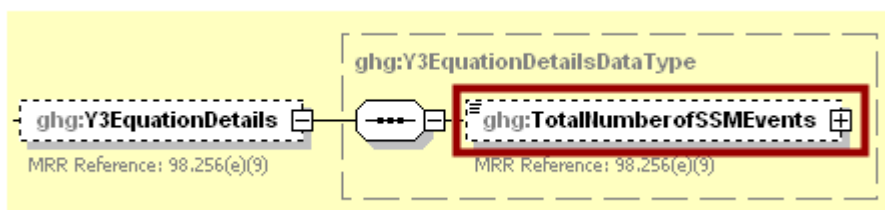

Note: Data elements boxed in red are required.

Conditionally Required: For each flare using the Equation Y-3 calculation method, the facility must identify the total number of start-up, shutdown, or malfunction (SSM) events exceeding 500,000 scf/day [98.256(e)(9)].

Table 20
Equation Y-3 Details Data Element Definitions

Data Element Name	Description
Y3EquationDetails	Parent Element (Conditionally Required): A collection of data elements to report if Equation Y-3 was used to calculate the CO ₂ emissions for the specified flare.
TotalNumberOfSSMEvents	Report the total number of start-up, shutdown, or malfunction (SSM) events exceeding 500,000 scf/day (integer).

XML Excerpt 17
Example for Equation Y-3 Details

```
<ghg:Y3EquationDetails>
  <ghg:TotalNumberOfSSMEvents>25</ghg:TotalNumberOfSSMEvents>
</ghg:Y3EquationDetails>
```

Note: The code excerpt above is presented here to demonstrate the concept of reporting greenhouse gas emissions data.

6.0 Facility-Level Roll-up Emissions

Each facility must report the following facility-level emission totals:

- Total CO₂ equivalent (CO₂e) emissions (excluding biogenic CO₂) aggregated across all direct emitter source categories (Subparts C-II, SS, and TT) associated with the facility.
- Total biogenic CO₂ emissions aggregated across all direct emitter source categories (Subparts C-II, SS, and TT) associated with the facility.

Each supplier must report the following supplier totals:

- Total CO₂e associated with products supplied aggregated across all supplier source categories (Subparts LL-QQ) associated with the facility

**Figure 32
Facility-Level Roll-up Emissions Schema Diagram**

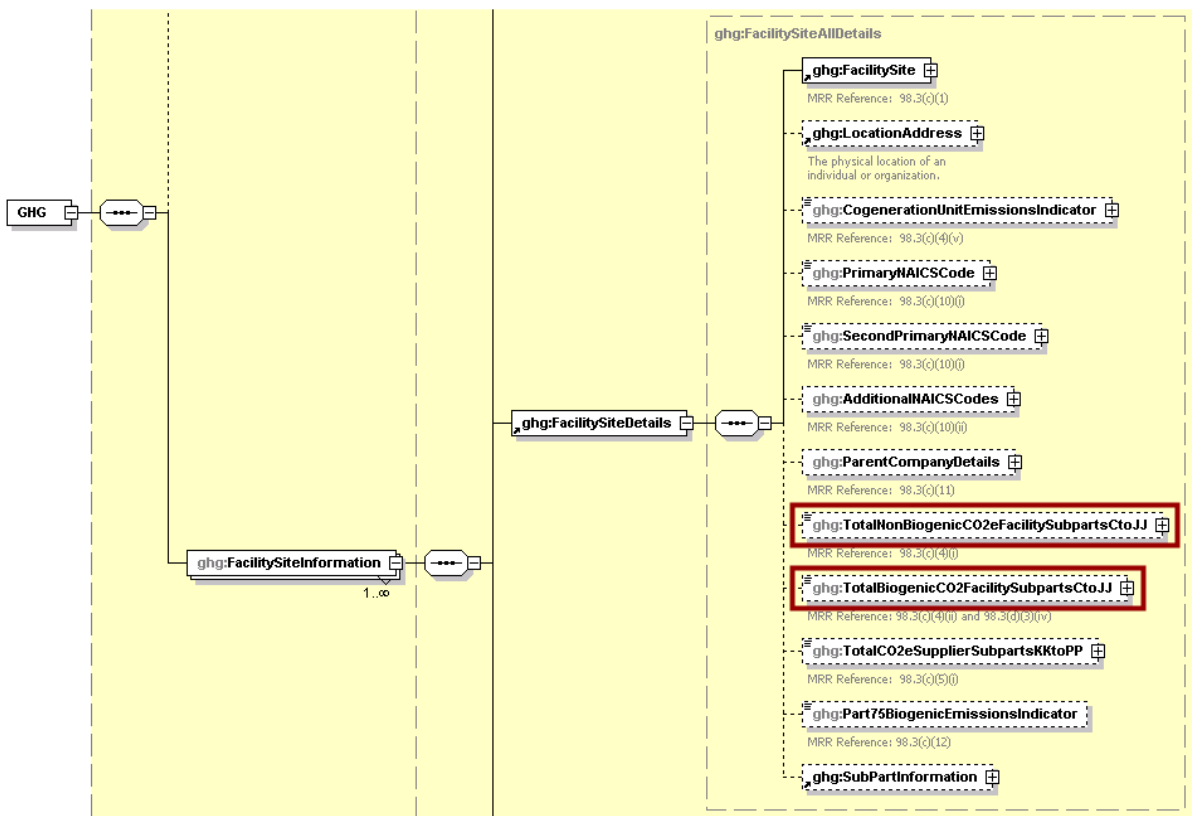

Note: Data elements boxed in red are required.

For the Subpart X portion of the facility –level emissions total, report total emissions for CO₂e (excluding biogenic CO₂) and biogenic CO₂ using the following guidelines.

- 1) Determine the total CO₂e value for Subpart X in metric tons (excluding biogenic CO₂) as follows:
 - Add the annual CO₂ mass emissions from process operations and process off-gas for each unit in metric tons rounded to nearest whole number.
 - Add the annual CO₂ mass emissions from each flare in metric tons rounded to nearest whole number.

- Add the total annual CO₂ mass emissions measured by each CEMS in metric tons rounded to nearest whole number minus the total annual biogenic CO₂ mass emissions for each CEMS monitoring location in metric tons rounded to nearest whole number (the difference of the total CO₂ monitored by each CEMS and the total biogenic CO₂).
 - Multiply the total annual CH₄ mass emissions from each flare in metric tons rounded to two decimal places by the Global Warming Potential for CH₄ and add the result.
 - Multiply the total annual N₂O mass emissions from each flare in metric tons rounded to three decimal places by the Global Warming Potential for N₂O and add the result.
 - Multiply the total annual CH₄ mass emissions for each CEMS monitoring location in metric tons rounded to two decimal places by the Global Warming Potential for CH₄ and add the result.
 - Multiply the total annual N₂O mass emissions for each CEMS monitoring location in metric tons rounded to three decimal places by the Global Warming Potential for N₂O and add the result.
- 2) Determine the total annual biogenic CO₂ mass emissions in metric tons rounded to nearest whole number for each CEMS monitoring location.

Table 21
Facility Level Roll-up Emissions Data Element Definitions

Data Element Name	Description
TotalNonBiogenicCO2eFacilitySubpartsCtoJJ	Add the total CO ₂ e value for Subpart X in metric tons to the total CO ₂ e emissions (excluding biogenic CO ₂) aggregated across all source category Subparts associated with the facility according to the guidelines above. Set the units of measure to “Metric Tons” in the attribute massUOM .
TotalBiogenicCO2FacilitySubpartsCtoJJ	Add the total annual biogenic CO ₂ value for Subpart X in metric tons to the total biogenic CO ₂ emissions aggregated across all source category Subparts associated with the facility according to the guideline above. Set the units of measure to “Metric Tons” in the attribute massUOM .

XML Excerpt 18
Example for Facility Level Roll-up Emissions

```

<ghg:TotalNonBiogenicCO2eFacilitySubpartsCtoJJ massUOM="Metric
Tons">33730.2</ghg:TotalNonBiogenicCO2eFacilitySubpartsCtoJJ>
<ghg:TotalBiogenicCO2FacilitySubpartsCtoJJ massUOM="Metric Tons">600.8</ghg:TotalBiogenicCO2FacilitySubpartsCtoJJ>
    
```

Note: The code excerpt above is presented here to demonstrate the concept of reporting greenhouse gas emissions data.

IV. Appendix A - Sample XML Document for Subpart X

(Note: Data values do not reflect an actual facility's emissions.)

```
<GHG xmlns="http://www.ccdsupport.com/schema/ghg">
  <FacilitySiteInformation>
    <CertificationStatement>The designated representative or alternate designated representative must sign (i.e.,
agree to) this certification statement. If you are an agent and you click on "SUBMIT", you are not agreeing to the
certification statement, but are submitting the certification statement on behalf of the designated representative or
alternate designated representative who is agreeing to the certification statement. An agent is only authorized to make the
electronic submission on behalf of the designated representative, not to sign (i.e., agree to) the certification
statement.</CertificationStatement>
    <ReportingYear>2020</ReportingYear>
  <FacilitySiteDetails>
    <FacilitySite>
      <FacilitySiteIdentifier>520938</FacilitySiteIdentifier>
      <FacilitySiteName>Subpart C Alt Part 75</FacilitySiteName>
    </FacilitySite>
    <LocationAddress>
      <LocationAddressText>123 Main St</LocationAddressText>
      <LocalityName>McLEAN</LocalityName>
      <StateIdentity>
        <StateCode>VA</StateCode>
      </StateIdentity>
      <AddressPostalCode>22102</AddressPostalCode>
    </LocationAddress>
    <CogenerationUnitEmissionsIndicator>N</CogenerationUnitEmissionsIndicator>
    <PrimaryNAICSCode>236116</PrimaryNAICSCode>
    <AdditionalNAICSCodes>
      <AdditionalNAICSCode>327910</AdditionalNAICSCode>
    </AdditionalNAICSCodes>
    <ParentCompanyDetails>
      <ParentCompany>
        <ParentCompanyLegalName>TEST1</ParentCompanyLegalName>
        <StreetAddress>123 Main St</StreetAddress>
        <City>Phenoix</City>
      </ParentCompany>
    </ParentCompanyDetails>
  </FacilitySiteDetails>
</FacilitySiteInformation>
</GHG>
```

```

        <State>AZ</State>
        <Zip>85001</Zip>
        <PercentOwnershipInterest>100</PercentOwnershipInterest>
    </ParentCompany>
    <ParentCompany>
        <ParentCompanyLegalName>ACADIA PARISH POLICE JURY</ParentCompanyLegalName>
        <StreetAddress>1710 SOLUTIONS DRIVE</StreetAddress>
        <City>McLEAN</City>
        <State>VA</State>
        <Zip>22102</Zip>
        <PercentOwnershipInterest>100</PercentOwnershipInterest>
    </ParentCompany>
</ParentCompanyDetails>
<TotalNonBiogenicCO2eFacilitySubpartsCtoJJ massUOM="Metric
Tons">100.2</TotalNonBiogenicCO2eFacilitySubpartsCtoJJ>
<TotalBiogenicCO2FacilitySubpartsCtoJJ massUOM="Metric Tons">10</TotalBiogenicCO2FacilitySubpartsCtoJJ>
<TotalCO2eSupplierSubpartsKKtoPP massUOM="Metric Tons">0</TotalCO2eSupplierSubpartsKKtoPP>
<PlantCodeIndicator>N</PlantCodeIndicator>
<SubPartInformation>
    <SubPartX>
        <GHGasInfoDetails>
            <GHGasName>Carbon Dioxide</GHGasName>fCE
            <GHGasQuantity massUOM="Metric Tons">
                <CalculatedValue>100.2</CalculatedValue>
            </GHGasQuantity>
        </GHGasInfoDetails>
        <GHGasInfoDetails>
            <GHGasName>Biogenic Carbon dioxide</GHGasName>
            <GHGasQuantity massUOM="Metric Tons">
                <CalculatedValue>10</CalculatedValue>
            </GHGasQuantity>
        </GHGasInfoDetails>
        <GHGasInfoDetails>
            <GHGasName>Methane</GHGasName>
            <GHGasQuantity massUOM="Metric Tons">
                <CalculatedValue>0</CalculatedValue>
            </GHGasQuantity>
        </GHGasInfoDetails>
    </SubPartX>

```

```
<GHGasInfoDetails>
  <GHGasName>Nitrous Oxide</GHGasName>
  <GHGasQuantity massUOM="Metric Tons">
    <CalculatedValue>0</CalculatedValue>
  </GHGasQuantity>
</GHGasInfoDetails>
<CEMSDetails>
  <CEMSUnitDetails>
    <UnitIdentification>
      <UnitName>CEMS1</UnitName>
      <UnitDescription>Test for EDC/VCM</UnitDescription>
      <UnitType>Petrochemical process unit</UnitType>
    </UnitIdentification>
    <XProductDetails>
      <PetroChemicalProductType>Ethylene dichloride</PetroChemicalProductType>
      <ProductQuantity massUOM="Metric Tons">
        <MeasureValue>100</MeasureValue>
      </ProductQuantity>
    </XProductDetails>
    <CEMSProductFeedStockDetails>
      <ProductOrFeedstockIndicator>Feedstock</ProductOrFeedstockIndicator>
      <Type>Ethylene</Type>
      <AnnualQuantity massUOM="Metric Tons">
        <MeasureValue>77</MeasureValue>
      </AnnualQuantity>
    </CEMSProductFeedStockDetails>
    <CEMSProductFeedStockDetails>
      <ProductOrFeedstockIndicator>Product</ProductOrFeedstockIndicator>
      <Type>Ethylene dichloride</Type>
      <AnnualQuantity massUOM="Metric Tons">
        <MeasureValue>88</MeasureValue>
      </AnnualQuantity>
    </CEMSProductFeedStockDetails>
  </CEMSUnitDetails>
</CEMSDetails>
  <UnitIdentification>
    <UnitName>EDC Direct</UnitName>
    <UnitType>Petrochemical process unit</UnitType>
```

```

</UnitIdentification>
<XProductDetails>
  <PetroChemicalProductType>Ethylene dichloride</PetroChemicalProductType>
  <ProductQuantity massUOM="Metric Tons">
    <MeasureValue>1</MeasureValue>
  </ProductQuantity>
</XProductDetails>
<CEMSProductFeedStockDetails>
  <ProductOrFeedstockIndicator>Feedstock</ProductOrFeedstockIndicator>
  <Type>Ethylene</Type>
  <AnnualQuantity massUOM="Metric Tons">
    <MeasureValue>11</MeasureValue>
  </AnnualQuantity>
</CEMSProductFeedStockDetails>
<CEMSProductFeedStockDetails>
  <ProductOrFeedstockIndicator>Product</ProductOrFeedstockIndicator>
  <Type>Ethylene dichloride</Type>
  <AnnualQuantity massUOM="Metric Tons">
    <MeasureValue>13</MeasureValue>
  </AnnualQuantity>
</CEMSProductFeedStockDetails>
</CEMSUnitDetails>
<XTier4CEMSDetails>
  <CEMSMonitoringLocation>
    <Name>Monitoring Location 1</Name>
    <Description>test</Description>
    <Type>Single process/process unit exhausts to dedicated stack</Type>
  </CEMSMonitoringLocation>
  <CO2EmissionsAllBiomassFuelsCombined massUOM="Metric Tons">
    <CalculatedValue>9</CalculatedValue>
  </CO2EmissionsAllBiomassFuelsCombined>
  <CO2EmissionsNonBiogenic massUOM="Metric Tons">
    <CalculatedValue>8</CalculatedValue>
  </CO2EmissionsNonBiogenic>
  <AnnualCO2EmissionsMeasuredByCEMS massUOM="Metric Tons">
    <CalculatedValue>10</CalculatedValue>
  </AnnualCO2EmissionsMeasuredByCEMS>
  <Tier4QuarterDetails>

```



```

        <QuarterName>First Quarter</QuarterName>
        <CumulativeCO2MassEmissions massUOM="Metric Tons">
            <CalculatedValue>1</CalculatedValue>
        </CumulativeCO2MassEmissions>
    </Tier4QuarterDetails>
    <Tier4QuarterDetails>
        <QuarterName>Second Quarter</QuarterName>
        <CumulativeCO2MassEmissions massUOM="Metric Tons">
            <CalculatedValue>2</CalculatedValue>
        </CumulativeCO2MassEmissions>
    </Tier4QuarterDetails>
    <Tier4QuarterDetails>
        <QuarterName>Third Quarter</QuarterName>
        <CumulativeCO2MassEmissions massUOM="Metric Tons">
            <CalculatedValue>3</CalculatedValue>
        </CumulativeCO2MassEmissions>
    </Tier4QuarterDetails>
    <Tier4QuarterDetails>
        <QuarterName>Fourth Quarter</QuarterName>
        <CumulativeCO2MassEmissions massUOM="Metric Tons">
            <CalculatedValue>4</CalculatedValue>
        </CumulativeCO2MassEmissions>
    </Tier4QuarterDetails>
    <TotalSourceOperatingHours>0</TotalSourceOperatingHours>
    <OperatingHoursDetails>
        <OperatingHoursCO2ConcentrationSubstituted>0</OperatingHoursCO2ConcentrationSubstituted>
        <OperatingHoursStackGasFlowRateSubstituted>0</OperatingHoursStackGasFlowRateSubstituted>
        <OperatingHoursStackGasMoistureContentSubstituted>0</OperatingHoursStackGasMoistureContentSubstituted>
    </OperatingHoursDetails>
    <TierMethodologyStartDate>2017-01-01</TierMethodologyStartDate>
    <TierMethodologyEndDate>2017-12-31</TierMethodologyEndDate>
    <SlipStreamIndicator>N</SlipStreamIndicator>
    <XProcessUnits>
        <ProcessUnitName>
            <UnitName>CEMS1</UnitName>

```

```

        </ProcessUnitName>
        <CarbonDioxideFractionProcessAndCombustion fractionUOM="decimal fraction">
            <MeasureValue>0.6</MeasureValue>
        </CarbonDioxideFractionProcessAndCombustion>
        <MethaneFraction fractionUOM="decimal fraction">
            <MeasureValue>0.8</MeasureValue>
        </MethaneFraction>
        <NitrousOxideFraction fractionUOM="decimal fraction">
            <MeasureValue>0.7</MeasureValue>
        </NitrousOxideFraction>
    </XProcessUnits>
</XTier4CEMSDetails>
<XTier4CEMSDetails>
    <CEMSMonitoringLocation>
        <Name>CEMS Locaiton 2</Name>
        <Type>Multiple processes/process units share common stack</Type>
    </CEMSMonitoringLocation>
    <CO2EmissionsAllBiomassFuelsCombined massUOM="Metric Tons">
        <CalculatedValue>1</CalculatedValue>
    </CO2EmissionsAllBiomassFuelsCombined>
    <CO2EmissionsNonBiogenic massUOM="Metric Tons">
        <CalculatedValue>2</CalculatedValue>
    </CO2EmissionsNonBiogenic>
    <AnnualCO2EmissionsMeasuredByCEMS massUOM="Metric Tons">
        <CalculatedValue>100</CalculatedValue>
    </AnnualCO2EmissionsMeasuredByCEMS>
    <Tier4QuarterDetails>
        <QuarterName>First Quarter</QuarterName>
        <CumulativeCO2MassEmissions massUOM="Metric Tons">
            <CalculatedValue>4</CalculatedValue>
        </CumulativeCO2MassEmissions>
    </Tier4QuarterDetails>
    <Tier4QuarterDetails>
        <QuarterName>Second Quarter</QuarterName>
        <CumulativeCO2MassEmissions massUOM="Metric Tons">
            <CalculatedValue>5</CalculatedValue>
        </CumulativeCO2MassEmissions>
    </Tier4QuarterDetails>

```

```
<Tier4QuarterDetails>
  <QuarterName>Third Quarter</QuarterName>
  <CumulativeCO2MassEmissions massUOM="Metric Tons">
    <CalculatedValue>6</CalculatedValue>
  </CumulativeCO2MassEmissions>
</Tier4QuarterDetails>
<Tier4QuarterDetails>
  <QuarterName>Fourth Quarter</QuarterName>
  <CumulativeCO2MassEmissions massUOM="Metric Tons">
    <CalculatedValue>8</CalculatedValue>
  </CumulativeCO2MassEmissions>
</Tier4QuarterDetails>
<TotalSourceOperatingHours>0</TotalSourceOperatingHours>
<OperatingHoursDetails>

<OperatingHoursCO2ConcentrationSubstituted>0</OperatingHoursCO2ConcentrationSubstituted>

<OperatingHoursStackGasFlowRateSubstituted>0</OperatingHoursStackGasFlowRateSubstituted>

<OperatingHoursStackGasMoistureContentSubstituted>0</OperatingHoursStackGasMoistureContentSubstituted>
</OperatingHoursDetails>
<TierMethodologyStartDate>2017-01-01</TierMethodologyStartDate>
<TierMethodologyEndDate>2017-12-31</TierMethodologyEndDate>
<SlipStreamIndicator>N</SlipStreamIndicator>
<XProcessUnits>
  <ProcessUnitName>
    <UnitName>EDC Direct</UnitName>
  </ProcessUnitName>
  <CarbonDioxideFractionProcessAndCombustion fractionUOM="decimal fraction">
    <MeasureValue>0.2</MeasureValue>
  </CarbonDioxideFractionProcessAndCombustion>
  <MethaneFraction fractionUOM="decimal fraction">
    <MeasureValue>0.4</MeasureValue>
  </MethaneFraction>
  <NitrousOxideFraction fractionUOM="decimal fraction">
    <MeasureValue>0.3</MeasureValue>
  </NitrousOxideFraction>
</XProcessUnits>
```

```
        </XTier4CEMSDetails>
    </CEMSDetails>

    <MassBalanceDetails>
        <UnitIdentification>
            <UnitName>Mass1, Stand alone EDC</UnitName>
            <UnitType>Petrochemical process unit</UnitType>
        </UnitIdentification>
        <AnnualCO2Emissions massUOM="Metric Tons">
            <CalculatedValue>0.0</CalculatedValue>
        </AnnualCO2Emissions>
        <CombustionUnitIdentifiers>None</CombustionUnitIdentifiers>
        <ProductFeedStockDetails>
            <ProductOrFeedstockIndicator>Feedstock</ProductOrFeedstockIndicator>
            <Name>1</Name>
            <Type>Ethylene</Type>
            <AnnualQuantity massUOM="Metric Tons">
                <MeasureValue>40</MeasureValue>
            </AnnualQuantity>
            <PhysicalState>Gaseous</PhysicalState>
            <FlowMeterDetails>
                <FlowOrMassDeterminationMethod>test</FlowOrMassDeterminationMethod>
            </FlowMeterDetails>
            <ProcessChangeDates>test</ProcessChangeDates>
            <MonthlyDetails>
                <MonthName>January</MonthName>
                <OtherProductFeedStockDetails>
                    <VolumeorMass>
                        <IsSubstitutedIndicator>Y</IsSubstitutedIndicator>
                    </VolumeorMass>
                    <VolumeorMassMethod>Flow meter</VolumeorMassMethod>
                    <CarbonContent>
                        <IsSubstitutedIndicator>N</IsSubstitutedIndicator>
                    </CarbonContent>
                </OtherProductFeedStockDetails>
            </MonthlyDetails>
        </ProductFeedStockDetails>
    </MassBalanceDetails>
```

```
        </CarbonContent>
        <CarbonContentMethod>Chromatographic analysis</CarbonContentMethod>
        <MolecularWeight>
          <IsSubstitutedIndicator>N</IsSubstitutedIndicator>
        </MolecularWeight>
        <MolecularWeightMethod>Calculated based on chemical formula and
atomic weights</MolecularWeightMethod>
        <VolumeTemperatureBasis>60 degrees
Fahrenheit</VolumeTemperatureBasis>
      </OtherProductFeedStockDetails>
    </MonthlyDetails>
    <MonthlyDetails>
      <MonthName>February</MonthName>
      <OtherProductFeedStockDetails>
        <VolumeorMass>
          <IsSubstitutedIndicator>N</IsSubstitutedIndicator>
        </VolumeorMass>
        <VolumeorMassMethod>Flow meter</VolumeorMassMethod>
        <CarbonContent>
          <IsSubstitutedIndicator>N</IsSubstitutedIndicator>
        </CarbonContent>
        <CarbonContentMethod>Chromatographic analysis</CarbonContentMethod>
        <MolecularWeight>
          <IsSubstitutedIndicator>N</IsSubstitutedIndicator>
        </MolecularWeight>
        <MolecularWeightMethod>Calculated based on chemical formula and
atomic weights</MolecularWeightMethod>
        <VolumeTemperatureBasis>60 degrees
Fahrenheit</VolumeTemperatureBasis>
      </OtherProductFeedStockDetails>
    </MonthlyDetails>
    <MonthlyDetails>
      <OtherProductFeedStockDetails>
        <VolumeorMass>
          <IsSubstitutedIndicator>Y</IsSubstitutedIndicator>
        </VolumeorMass>
        <VolumeorMassMethod>Flow meter</VolumeorMassMethod>
        <CarbonContent>
```

```

        <IsSubstitutedIndicator>N</IsSubstitutedIndicator>
      </CarbonContent>
      <CarbonContentMethod>Chromatographic analysis</CarbonContentMethod>
      <MolecularWeight>
        <IsSubstitutedIndicator>N</IsSubstitutedIndicator>
      </MolecularWeight>
      <MolecularWeightMethod>Calculated based on chemical formula and
atomic weights</MolecularWeightMethod>
      <VolumeTemperatureBasis>60 degrees
Fahrenheit</VolumeTemperatureBasis>
    </OtherProductFeedStockDetails>
  </MonthlyDetails>
<MonthlyDetails>
  <MonthName>April</MonthName>
  <OtherProductFeedStockDetails>
    <VolumeorMass>
      <IsSubstitutedIndicator>Y</IsSubstitutedIndicator>
    </VolumeorMass>
    <VolumeorMassMethod>Flow meter</VolumeorMassMethod>
    <CarbonContent>
      <IsSubstitutedIndicator>N</IsSubstitutedIndicator>
    </CarbonContent>
    <CarbonContentMethod>Chromatographic analysis</CarbonContentMethod>
    <MolecularWeight>
      <IsSubstitutedIndicator>N</IsSubstitutedIndicator>
    </MolecularWeight>
    <MolecularWeightMethod>Calculated based on chemical formula and
atomic weights</MolecularWeightMethod>
    <VolumeTemperatureBasis>60 degrees
Fahrenheit</VolumeTemperatureBasis>
  </OtherProductFeedStockDetails>
</MonthlyDetails>
<MonthlyDetails>
  <MonthName>May</MonthName>
  <OtherProductFeedStockDetails>
    <VolumeorMass>
      <IsSubstitutedIndicator>Y</IsSubstitutedIndicator>
    </VolumeorMass>

```

```
<VolumeorMassMethod>Flow meter</VolumeorMassMethod>
<CarbonContent>
  <IsSubstitutedIndicator>N</IsSubstitutedIndicator>
</CarbonContent>
<CarbonContentMethod>Chromatographic analysis</CarbonContentMethod>
<MolecularWeight>
  <IsSubstitutedIndicator>N</IsSubstitutedIndicator>
</MolecularWeight>
<MolecularWeightMethod>Calculated based on chemical formula and
atomic weights</MolecularWeightMethod>
<VolumeTemperatureBasis>60 degrees
Fahrenheit</VolumeTemperatureBasis>
</OtherProductFeedStockDetails>
</MonthlyDetails>
<MonthlyDetails>
  <MonthName>June</MonthName>
  <OtherProductFeedStockDetails>
    <VolumeorMass>
      <IsSubstitutedIndicator>Y</IsSubstitutedIndicator>
    </VolumeorMass>
    <VolumeorMassMethod>Flow meter</VolumeorMassMethod>
    <CarbonContent>
      <IsSubstitutedIndicator>N</IsSubstitutedIndicator>
    </CarbonContent>
    <CarbonContentMethod>Chromatographic analysis</CarbonContentMethod>
    <MolecularWeight>
      <IsSubstitutedIndicator>N</IsSubstitutedIndicator>
    </MolecularWeight>
    <MolecularWeightMethod>Calculated based on chemical formula and
atomic weights</MolecularWeightMethod>
    <VolumeTemperatureBasis>60 degrees
    Fahrenheit</VolumeTemperatureBasis>
  </OtherProductFeedStockDetails>
</MonthlyDetails>
<MonthlyDetails>
  <MonthName>July</MonthName>

  <OtherProductFeedStockDetails>
```

```

    <VolumeorMass>
      <IsSubstitutedIndicator>Y</IsSubstitutedIndicator>
    </VolumeorMass>
    <VolumeorMassMethod>Flow meter</VolumeorMassMethod>
    <CarbonContent>
      <IsSubstitutedIndicator>N</IsSubstitutedIndicator>
    </CarbonContent>
    <CarbonContentMethod>Chromatographic analysis</CarbonContentMethod>
    <MolecularWeight>
      <IsSubstitutedIndicator>N</IsSubstitutedIndicator>
    </MolecularWeight>
    <MolecularWeightMethod>Calculated based on chemical formula and
atomic weights</MolecularWeightMethod>
    <VolumeTemperatureBasis>60 degrees
Fahrenheit</VolumeTemperatureBasis>
  </OtherProductFeedStockDetails>
</MonthlyDetails>
<MonthlyDetails>
  <MonthName>August</MonthName>
  <OtherProductFeedStockDetails>
    <VolumeorMass>
      <IsSubstitutedIndicator>Y</IsSubstitutedIndicator>
    </VolumeorMass>
    <VolumeorMassMethod>Flow meter</VolumeorMassMethod>
    <CarbonContent>
      <IsSubstitutedIndicator>N</IsSubstitutedIndicator>
    </CarbonContent>
    <CarbonContentMethod>Chromatographic analysis</CarbonContentMethod>
    <MolecularWeight>
      <IsSubstitutedIndicator>N</IsSubstitutedIndicator>
    </MolecularWeight>
    <MolecularWeightMethod>Calculated based on chemical formula and
atomic weights</MolecularWeightMethod>
    <VolumeTemperatureBasis>60 degrees
Fahrenheit</VolumeTemperatureBasis>
  </OtherProductFeedStockDetails>
</MonthlyDetails>
<MonthlyDetails>

```



```
<MonthName>September</MonthName>
<OtherProductFeedStockDetails>
  <VolumeorMass>
    <IsSubstitutedIndicator>Y</IsSubstitutedIndicator>
  </VolumeorMass>
  <VolumeorMassMethod>Flow meter</VolumeorMassMethod>
  <CarbonContent>
    <IsSubstitutedIndicator>N</IsSubstitutedIndicator>
  </CarbonContent>
  <CarbonContentMethod>Chromatographic analysis</CarbonContentMethod>
  <MolecularWeight>
    <IsSubstitutedIndicator>N</IsSubstitutedIndicator>
  </MolecularWeight>
  <MolecularWeightMethod>Calculated based on chemical formula and
atomic weights</MolecularWeightMethod>
  <VolumeTemperatureBasis>60 degrees
Fahrenheit</VolumeTemperatureBasis>
</OtherProductFeedStockDetails>
</MonthlyDetails>
<MonthlyDetails>
  <MonthName>October</MonthName>
  <OtherProductFeedStockDetails>
    <VolumeorMass>
      <IsSubstitutedIndicator>Y</IsSubstitutedIndicator>
    </VolumeorMass>
    <VolumeorMassMethod>Flow meter</VolumeorMassMethod>
    <CarbonContent>
      <IsSubstitutedIndicator>N</IsSubstitutedIndicator>
    </CarbonContent>
    <CarbonContentMethod>Chromatographic analysis</CarbonContentMethod>
    <MolecularWeight>
      <IsSubstitutedIndicator>N</IsSubstitutedIndicator>
    </MolecularWeight>
    <MolecularWeightMethod>Calculated based on chemical formula and
atomic weights</MolecularWeightMethod>
    <VolumeTemperatureBasis>60 degrees
Fahrenheit</VolumeTemperatureBasis>
  </OtherProductFeedStockDetails>
</MonthlyDetails>
```

```
</MonthlyDetails>
<MonthlyDetails>
  <MonthName>November</MonthName>
  <OtherProductFeedStockDetails>
    <VolumeorMass>
      <IsSubstitutedIndicator>Y</IsSubstitutedIndicator>
    </VolumeorMass>
    <VolumeorMassMethod>Flow meter</VolumeorMassMethod>
    <CarbonContent>
      <IsSubstitutedIndicator>N</IsSubstitutedIndicator>
    </CarbonContent>
    <CarbonContentMethod>Chromatographic analysis</CarbonContentMethod>
    <MolecularWeight>
      <IsSubstitutedIndicator>N</IsSubstitutedIndicator>
    </MolecularWeight>
    <MolecularWeightMethod>Calculated based on chemical formula and
atomic weights</MolecularWeightMethod>
    <VolumeTemperatureBasis>60 degrees
Fahrenheit</VolumeTemperatureBasis>
  </OtherProductFeedStockDetails>
</MonthlyDetails>
<MonthlyDetails>
  <MonthName>December</MonthName>
  <OtherProductFeedStockDetails>
    <VolumeorMass>
      <IsSubstitutedIndicator>Y</IsSubstitutedIndicator>
    </VolumeorMass>
    <VolumeorMassMethod>Flow meter</VolumeorMassMethod>
    <CarbonContent>
      <IsSubstitutedIndicator>N</IsSubstitutedIndicator>
    </CarbonContent>
    <CarbonContentMethod>Chromatographic analysis</CarbonContentMethod>
    <MolecularWeight>
      <IsSubstitutedIndicator>N</IsSubstitutedIndicator>
    </MolecularWeight>
    <MolecularWeightMethod>Calculated based on chemical formula and
atomic weights</MolecularWeightMethod>
```

```
        <VolumeTemperatureBasis>60 degrees
        Fahrenheit</VolumeTemperatureBasis>
      </OtherProductFeedStockDetails>
    </MonthlyDetails>
  </ProductFeedStockDetails>
<ProductFeedStockDetails>
  <ProductOrFeedstockIndicator>Product</ProductOrFeedstockIndicator>
  <Name>1</Name>
  <Type>Ethylene dichloride</Type>
  <AnnualQuantity massUOM="Metric Tons">
    <MeasureValue>39</MeasureValue>
  </AnnualQuantity>
  <PhysicalState>Liquid</PhysicalState>
  <FlowMeterDetails>
    <FlowOrMassDeterminationMethod>test</FlowOrMassDeterminationMethod>
  </FlowMeterDetails>
  <ProcessChangeDates>test</ProcessChangeDates>
  <MonthlyDetails>
    <MonthName>January</MonthName>
    <OtherProductFeedStockDetails>
      <VolumeorMass>
        <IsSubstitutedIndicator>N</IsSubstitutedIndicator>
      </VolumeorMass>
      <VolumeorMassMethod>Weighing device</VolumeorMassMethod>
      <CarbonContent>
        <IsSubstitutedIndicator>N</IsSubstitutedIndicator>
      </CarbonContent>
      <CarbonContentMethod>Chromatographic analysis</CarbonContentMethod>
      <MolecularWeight>
        <IsSubstitutedIndicator>N</IsSubstitutedIndicator>
      </MolecularWeight>
    </OtherProductFeedStockDetails>
  </MonthlyDetails>
<MonthlyDetails>
  <MonthName>February</MonthName>
  <OtherProductFeedStockDetails>
    <VolumeorMass>
      <IsSubstitutedIndicator>N</IsSubstitutedIndicator>
    </VolumeorMass>
  </OtherProductFeedStockDetails>
</MonthlyDetails>
```

```
        </VolumeorMass>
        <VolumeorMassMethod>Weighing device</VolumeorMassMethod>
        <CarbonContent>
          <IsSubstitutedIndicator>N</IsSubstitutedIndicator>
        </CarbonContent>
        <CarbonContentMethod>Chromatographic analysis</CarbonContentMethod>
        <MolecularWeight>
          <IsSubstitutedIndicator>N</IsSubstitutedIndicator>
        </MolecularWeight>
      </OtherProductFeedStockDetails>
    </MonthlyDetails>
  <MonthlyDetails>
    <MonthName>March</MonthName>
    <OtherProductFeedStockDetails>
      <VolumeorMass>
        <IsSubstitutedIndicator>N</IsSubstitutedIndicator>
      </VolumeorMass>
      <VolumeorMassMethod>Weighing device</VolumeorMassMethod>
      <CarbonContent>
        <IsSubstitutedIndicator>N</IsSubstitutedIndicator>
      </CarbonContent>
      <CarbonContentMethod>Chromatographic analysis</CarbonContentMethod>
      <MolecularWeight>
        <IsSubstitutedIndicator>N</IsSubstitutedIndicator>
      </MolecularWeight>
    </OtherProductFeedStockDetails>
  </MonthlyDetails>
  <MonthlyDetails>
    <MonthName>April</MonthName>
    <OtherProductFeedStockDetails>
      <VolumeorMass>
        <IsSubstitutedIndicator>N</IsSubstitutedIndicator>
      </VolumeorMass>
      <VolumeorMassMethod>Weighing device</VolumeorMassMethod>
      <CarbonContent>
        <IsSubstitutedIndicator>N</IsSubstitutedIndicator>
      </CarbonContent>
      <CarbonContentMethod>Chromatographic analysis</CarbonContentMethod>
```

```
                <MolecularWeight>
                    <IsSubstitutedIndicator>N</IsSubstitutedIndicator>
                </MolecularWeight>
            </OtherProductFeedStockDetails>
        </MonthlyDetails>
    <MonthlyDetails>
        <MonthName>May</MonthName>
        <OtherProductFeedStockDetails>
            <VolumeorMass>
                <IsSubstitutedIndicator>N</IsSubstitutedIndicator>
            </VolumeorMass>
            <VolumeorMassMethod>Weighing device</VolumeorMassMethod>
            <CarbonContent>
                <IsSubstitutedIndicator>N</IsSubstitutedIndicator>
            </CarbonContent>
            <CarbonContentMethod>Chromatographic analysis</CarbonContentMethod>
            <MolecularWeight>
                <IsSubstitutedIndicator>N</IsSubstitutedIndicator>
            </MolecularWeight>
        </OtherProductFeedStockDetails>
    </MonthlyDetails>
</MonthlyDetails>
<MonthlyDetails>
    <MonthName>June</MonthName>
    <OtherProductFeedStockDetails>
        <VolumeorMass>
            <IsSubstitutedIndicator>N</IsSubstitutedIndicator>
        </VolumeorMass>
        <VolumeorMassMethod>Weighing device</VolumeorMassMethod>
        <CarbonContent>
            <IsSubstitutedIndicator>N</IsSubstitutedIndicator>
        </CarbonContent>
        <CarbonContentMethod>Chromatographic analysis</CarbonContentMethod>
        <MolecularWeight>
            <IsSubstitutedIndicator>N</IsSubstitutedIndicator>
        </MolecularWeight>
    </OtherProductFeedStockDetails>
</MonthlyDetails>
<MonthlyDetails>
```

```
<MonthName>July</MonthName>
<OtherProductFeedStockDetails>
  <VolumeorMass>
    <IsSubstitutedIndicator>N</IsSubstitutedIndicator>
  </VolumeorMass>
  <VolumeorMassMethod>Weighing device</VolumeorMassMethod>
  <CarbonContent>
    <IsSubstitutedIndicator>N</IsSubstitutedIndicator>
  </CarbonContent>
  <CarbonContentMethod>Chromatographic analysis</CarbonContentMethod>
  <MolecularWeight>
    <IsSubstitutedIndicator>N</IsSubstitutedIndicator>
  </MolecularWeight>
</OtherProductFeedStockDetails>
</MonthlyDetails>
<MonthlyDetails>
  <MonthName>August</MonthName>
  <OtherProductFeedStockDetails>
    <VolumeorMass>
      <IsSubstitutedIndicator>N</IsSubstitutedIndicator>
    </VolumeorMass>
    <VolumeorMassMethod>Weighing device</VolumeorMassMethod>
    <CarbonContent>
      <IsSubstitutedIndicator>N</IsSubstitutedIndicator>
    </CarbonContent>
    <CarbonContentMethod>Chromatographic analysis</CarbonContentMethod>
    <MolecularWeight>
      <IsSubstitutedIndicator>N</IsSubstitutedIndicator>
    </MolecularWeight>
  </OtherProductFeedStockDetails>
</MonthlyDetails>
<MonthlyDetails>
  <MonthName>September</MonthName>
  <OtherProductFeedStockDetails>
    <VolumeorMass>
      <IsSubstitutedIndicator>N</IsSubstitutedIndicator>
    </VolumeorMass>
    <VolumeorMassMethod>Weighing device</VolumeorMassMethod>
```

```
        <CarbonContent>
          <IsSubstitutedIndicator>N</IsSubstitutedIndicator>
        </CarbonContent>
        <CarbonContentMethod>Chromatographic analysis</CarbonContentMethod>
        <MolecularWeight>
          <IsSubstitutedIndicator>N</IsSubstitutedIndicator>
        </MolecularWeight>
      </OtherProductFeedStockDetails>
    </MonthlyDetails>
  <MonthlyDetails>
    <MonthName>October</MonthName>
    <OtherProductFeedStockDetails>
      <VolumeorMass>
        <IsSubstitutedIndicator>N</IsSubstitutedIndicator>
      </VolumeorMass>
      <VolumeorMassMethod>Weighing device</VolumeorMassMethod>
      <CarbonContent>
        <IsSubstitutedIndicator>N</IsSubstitutedIndicator>
      </CarbonContent>
      <CarbonContentMethod>Chromatographic analysis</CarbonContentMethod>
      <MolecularWeight>
        <IsSubstitutedIndicator>N</IsSubstitutedIndicator>
      </MolecularWeight>
    </OtherProductFeedStockDetails>
  </MonthlyDetails>
  <MonthlyDetails>
    <MonthName>November</MonthName>
    <OtherProductFeedStockDetails>
      <VolumeorMass>
        <IsSubstitutedIndicator>N</IsSubstitutedIndicator>
      </VolumeorMass>
      <VolumeorMassMethod>Weighing device</VolumeorMassMethod>
      <CarbonContent>
        <IsSubstitutedIndicator>N</IsSubstitutedIndicator>
      </CarbonContent>
      <CarbonContentMethod>Chromatographic analysis</CarbonContentMethod>
      <MolecularWeight>
        <IsSubstitutedIndicator>N</IsSubstitutedIndicator>
      </MolecularWeight>
    </OtherProductFeedStockDetails>
  </MonthlyDetails>
</MonthlyDetails>
```

```

        </MolecularWeight>
      </OtherProductFeedStockDetails>
    </MonthlyDetails>
  <MonthlyDetails>
    <MonthName>December</MonthName>
    <OtherProductFeedStockDetails>
      <VolumeorMass>
        <IsSubstitutedIndicator>N</IsSubstitutedIndicator>
      </VolumeorMass>
      <VolumeorMassMethod>Weighing device</VolumeorMassMethod>
      <CarbonContent>
        <IsSubstitutedIndicator>N</IsSubstitutedIndicator>
      </CarbonContent>
      <CarbonContentMethod>Chromatographic analysis</CarbonContentMethod>
      <MolecularWeight>
        <IsSubstitutedIndicator>N</IsSubstitutedIndicator>
      </MolecularWeight>
    </OtherProductFeedStockDetails>
  </MonthlyDetails>
</ProductFeedStockDetails>
<XProductDetails>
  <PetroChemicalProductType>Ethylene dichloride (stand-alone EDC
  process)</PetroChemicalProductType>
  <ProductQuantity massUOM="Metric Tons">
    <MeasureValue>100</MeasureValue>
  </ProductQuantity>
  <EthyleneDichlorideProduced>Stand-alone EDC Process</EthyleneDichlorideProduced>
</XProductDetails>
<AdditionalDetails>
  <CarbonContentofWasteWater fractionUOM="decimal fraction">
    <MeasureValue>0.23</MeasureValue>
  </CarbonContentofWasteWater>
  <AnnualAverageWasteWaterFlow UnitsofMeasure="gal">
    <MeasureValue>100</MeasureValue>
  </AnnualAverageWasteWaterFlow>
  <CarbonMassofFugitiveEmissions massUOM="Metric Tons">
    <MeasureValue>1</MeasureValue>
  </CarbonMassofFugitiveEmissions>

```



```

        <CarbonMassofProcessVents massUOM="Metric Tons">
            <MeasureValue>2</MeasureValue>
        </CarbonMassofProcessVents>
    </AdditionalDetails>
    <AnnualAverageXivtDetails>
        <ProductOrFeedstockIndicator>Feedstock</ProductOrFeedstockIndicator>
        <UnqiueIdentifier>1</UnqiueIdentifier>
        <Name>Ethylene dichloride</Name>
        <PhysicalState>Solid</PhysicalState>
        <AverageCarbonContentValue carboncontentUOM="kgC/kg">
            <CalculatedValue>0.400</CalculatedValue>
            <OverrideIndicator>N</OverrideIndicator>
        </AverageCarbonContentValue>
    </AnnualAverageXivtDetails>
    <AnnualAverageXivtDetails>
        <ProductOrFeedstockIndicator>Product</ProductOrFeedstockIndicator>
        <UnqiueIdentifier>1</UnqiueIdentifier>
        <Name>Ethylene dichloride</Name>
        <PhysicalState>Liquid</PhysicalState>
        <AverageCarbonContentValue carboncontentUOM="kgC/kg">
            <CalculatedValue>0.050</CalculatedValue>
            <OverrideIndicator>N</OverrideIndicator>
        </AverageCarbonContentValue>
    </AnnualAverageXivtDetails>
</MassBalanceDetails>
<MassBalanceDetails>
    <UnitIdentification>
        <UnitName>Mass 2, Integrated EDV/VCM</UnitName>
        <UnitDescription>Integrated EDV/VCM</UnitDescription>
        <UnitType>Petrochemical process unit</UnitType>
    </UnitIdentification>
    <AnnualCO2Emissions massUOM="Metric Tons">
        <CalculatedValue>0.2</CalculatedValue>
    </AnnualCO2Emissions>
    <CombustionUnitIdentifiers>none</CombustionUnitIdentifiers>
    <ProductFeedStockDetails>
        <ProductOrFeedstockIndicator>Feedstock</ProductOrFeedstockIndicator>
        <Name>1</Name>
    </ProductFeedStockDetails>

```

```
<Type>Ethylene dichloride</Type>
<AnnualQuantity massUOM="Metric Tons">
  <MeasureValue>30</MeasureValue>
</AnnualQuantity>
<PhysicalState>Solid</PhysicalState>
<FlowMeterDetails>
  <FlowOrMassDeterminationMethod>non</FlowOrMassDeterminationMethod>
</FlowMeterDetails>
<ProcessChangeDates>none</ProcessChangeDates>
<MonthlyDetails>
  <MonthName>January</MonthName>
  <OtherProductFeedStockDetails>
    <VolumeorMass>
      <IsSubstitutedIndicator>N</IsSubstitutedIndicator>
    </VolumeorMass>
    <VolumeorMassMethod>Flow meter</VolumeorMassMethod>
    <CarbonContent>
      <IsSubstitutedIndicator>N</IsSubstitutedIndicator>
    </CarbonContent>
    <CarbonContentMethod>ASTM UOP539-97</CarbonContentMethod>
    <MolecularWeight>
      <IsSubstitutedIndicator>N</IsSubstitutedIndicator>
    </MolecularWeight>
  </OtherProductFeedStockDetails>
</MonthlyDetails>
<MonthlyDetails>
  <MonthName>February</MonthName>
  <OtherProductFeedStockDetails>
    <VolumeorMass>
      <IsSubstitutedIndicator>N</IsSubstitutedIndicator>
    </VolumeorMass>
    <VolumeorMassMethod>Flow meter</VolumeorMassMethod>
    <CarbonContent>
      <IsSubstitutedIndicator>N</IsSubstitutedIndicator>
    </CarbonContent>
    <CarbonContentMethod>ASTM UOP539-97</CarbonContentMethod>
    <MolecularWeight>
      <IsSubstitutedIndicator>N</IsSubstitutedIndicator>
    </MolecularWeight>
  </OtherProductFeedStockDetails>
</MonthlyDetails>
```

```
        </MolecularWeight>
      </OtherProductFeedStockDetails>
    </MonthlyDetails>
  <MonthlyDetails>
    <MonthName>March</MonthName>
    <OtherProductFeedStockDetails>
      <VolumeorMass>
        <IsSubstitutedIndicator>N</IsSubstitutedIndicator>
      </VolumeorMass>
      <VolumeorMassMethod>Flow meter</VolumeorMassMethod>
      <CarbonContent>
        <IsSubstitutedIndicator>N</IsSubstitutedIndicator>
      </CarbonContent>
      <CarbonContentMethod>ASTM UOP539-97</CarbonContentMethod>
      <MolecularWeight>
        <IsSubstitutedIndicator>N</IsSubstitutedIndicator>
      </MolecularWeight>
    </OtherProductFeedStockDetails>
  </MonthlyDetails>
  <MonthlyDetails>
    <MonthName>April</MonthName>
    <OtherProductFeedStockDetails>
      <VolumeorMass>
        <IsSubstitutedIndicator>N</IsSubstitutedIndicator>
      </VolumeorMass>
      <VolumeorMassMethod>Flow meter</VolumeorMassMethod>
      <CarbonContent>
        <IsSubstitutedIndicator>N</IsSubstitutedIndicator>
      </CarbonContent>
      <CarbonContentMethod>ASTM UOP539-97</CarbonContentMethod>
      <MolecularWeight>
        <IsSubstitutedIndicator>N</IsSubstitutedIndicator>
      </MolecularWeight>
    </OtherProductFeedStockDetails>
  </MonthlyDetails>
  <MonthlyDetails>
    <MonthName>May</MonthName>
    <OtherProductFeedStockDetails>
```

```
<VolumeorMass>
  <IsSubstitutedIndicator>N</IsSubstitutedIndicator>
</VolumeorMass>
<VolumeorMassMethod>Flow meter</VolumeorMassMethod>
<CarbonContent>
  <IsSubstitutedIndicator>N</IsSubstitutedIndicator>
</CarbonContent>
<CarbonContentMethod>ASTM UOP539-97</CarbonContentMethod>
<MolecularWeight>
  <IsSubstitutedIndicator>N</IsSubstitutedIndicator>
</MolecularWeight>
</OtherProductFeedStockDetails>
</MonthlyDetails>
<MonthlyDetails>
  <MonthName>June</MonthName>
  <OtherProductFeedStockDetails>
    <VolumeorMass>
      <IsSubstitutedIndicator>N</IsSubstitutedIndicator>
    </VolumeorMass>
    <VolumeorMassMethod>Flow meter</VolumeorMassMethod>
    <CarbonContent>
      <IsSubstitutedIndicator>N</IsSubstitutedIndicator>
    </CarbonContent>
    <CarbonContentMethod>ASTM UOP539-97</CarbonContentMethod>
    <MolecularWeight>
      <IsSubstitutedIndicator>N</IsSubstitutedIndicator>
    </MolecularWeight>
  </OtherProductFeedStockDetails>
</MonthlyDetails>
<MonthlyDetails>
  <MonthName>July</MonthName>
  <OtherProductFeedStockDetails>
    <VolumeorMass>
      <IsSubstitutedIndicator>N</IsSubstitutedIndicator>
    </VolumeorMass>
    <VolumeorMassMethod>Flow meter</VolumeorMassMethod>
    <CarbonContent>
      <IsSubstitutedIndicator>N</IsSubstitutedIndicator>
    </CarbonContent>
```

```
        </CarbonContent>
        <CarbonContentMethod>ASTM UOP539-97</CarbonContentMethod>
        <MolecularWeight>
            <IsSubstitutedIndicator>N</IsSubstitutedIndicator>
        </MolecularWeight>
    </OtherProductFeedStockDetails>
</MonthlyDetails>
<MonthlyDetails>
    <MonthName>August</MonthName>
    <OtherProductFeedStockDetails>
        <VolumeorMass>
            <IsSubstitutedIndicator>N</IsSubstitutedIndicator>
        </VolumeorMass>
        <VolumeorMassMethod>Flow meter</VolumeorMassMethod>
        <CarbonContent>
            <IsSubstitutedIndicator>N</IsSubstitutedIndicator>
        </CarbonContent>
        <CarbonContentMethod>ASTM UOP539-97</CarbonContentMethod>
        <MolecularWeight>
            <IsSubstitutedIndicator>N</IsSubstitutedIndicator>
        </MolecularWeight>
    </OtherProductFeedStockDetails>
</MonthlyDetails>
<MonthlyDetails>
    <MonthName>September</MonthName>
    <OtherProductFeedStockDetails>
        <VolumeorMass>
            <IsSubstitutedIndicator>N</IsSubstitutedIndicator>
        </VolumeorMass>
        <VolumeorMassMethod>Flow meter</VolumeorMassMethod>
        <CarbonContent>
            <IsSubstitutedIndicator>N</IsSubstitutedIndicator>
        </CarbonContent>
        <CarbonContentMethod>ASTM UOP539-97</CarbonContentMethod>
        <MolecularWeight>
            <IsSubstitutedIndicator>N</IsSubstitutedIndicator>
        </MolecularWeight>
    </OtherProductFeedStockDetails>
```

```
</MonthlyDetails>
<MonthlyDetails>
  <MonthName>October</MonthName>
  <OtherProductFeedStockDetails>
    <VolumeorMass>
      <IsSubstitutedIndicator>N</IsSubstitutedIndicator>
    </VolumeorMass>
    <VolumeorMassMethod>Flow meter</VolumeorMassMethod>
    <CarbonContent>
      <IsSubstitutedIndicator>N</IsSubstitutedIndicator>
    </CarbonContent>
    <CarbonContentMethod>ASTM UOP539-97</CarbonContentMethod>
    <MolecularWeight>
      <IsSubstitutedIndicator>N</IsSubstitutedIndicator>
    </MolecularWeight>
  </OtherProductFeedStockDetails>
</MonthlyDetails>
<MonthlyDetails>
  <MonthName>November</MonthName>
  <OtherProductFeedStockDetails>
    <VolumeorMass>
      <IsSubstitutedIndicator>N</IsSubstitutedIndicator>
    </VolumeorMass>
    <VolumeorMassMethod>Flow meter</VolumeorMassMethod>
    <CarbonContent>
      <IsSubstitutedIndicator>N</IsSubstitutedIndicator>
    </CarbonContent>
    <CarbonContentMethod>ASTM UOP539-97</CarbonContentMethod>
    <MolecularWeight>
      <IsSubstitutedIndicator>N</IsSubstitutedIndicator>
    </MolecularWeight>
  </OtherProductFeedStockDetails>
</MonthlyDetails>
<MonthlyDetails>
  <MonthName>December</MonthName>
  <OtherProductFeedStockDetails>
    <VolumeorMass>
      <IsSubstitutedIndicator>N</IsSubstitutedIndicator>
```

```
        </VolumeorMass>
        <VolumeorMassMethod>Flow meter</VolumeorMassMethod>
        <CarbonContent>
          <IsSubstitutedIndicator>N</IsSubstitutedIndicator>
        </CarbonContent>
        <CarbonContentMethod>ASTM UOP539-97</CarbonContentMethod>
        <MolecularWeight>
          <IsSubstitutedIndicator>N</IsSubstitutedIndicator>
        </MolecularWeight>
      </OtherProductFeedStockDetails>
    </MonthlyDetails>
  </ProductFeedStockDetails>
<ProductFeedStockDetails>
  <ProductOrFeedstockIndicator>Product</ProductOrFeedstockIndicator>
  <Name>1</Name>
  <Type>Ethylene dichloride</Type>
  <AnnualQuantity massUOM="Metric Tons">
    <MeasureValue>55</MeasureValue>
  </AnnualQuantity>
  <PhysicalState>Liquid</PhysicalState>
  <FlowMeterDetails>
    <FlowOrMassDeterminationMethod>test</FlowOrMassDeterminationMethod>
  </FlowMeterDetails>
  <ProcessChangeDates>test</ProcessChangeDates>
  <MonthlyDetails>
    <MonthName>January</MonthName>
    <OtherProductFeedStockDetails>
      <VolumeorMass>
        <IsSubstitutedIndicator>N</IsSubstitutedIndicator>
      </VolumeorMass>
      <VolumeorMassMethod>Tank level measurements</VolumeorMassMethod>
      <CarbonContent>
        <IsSubstitutedIndicator>N</IsSubstitutedIndicator>
      </CarbonContent>
      <CarbonContentMethod>ASTM D5373-08</CarbonContentMethod>
      <MolecularWeight>
        <IsSubstitutedIndicator>N</IsSubstitutedIndicator>
      </MolecularWeight>
    </OtherProductFeedStockDetails>
  </MonthlyDetails>
</ProductFeedStockDetails>
</ProductFeedStockDetails>
```

```

        </OtherProductFeedStockDetails>
    </MonthlyDetails>
    <MonthlyDetails>
        <MonthName>February</MonthName>
        <OtherProductFeedStockDetails>
            <VolumeorMass>
                <IsSubstitutedIndicator>N</IsSubstitutedIndicator>
            </VolumeorMass>
            <VolumeorMassMethod>Tank level measurements</VolumeorMassMethod>
            <CarbonContent>
                <IsSubstitutedIndicator>N</IsSubstitutedIndicator>
            </CarbonContent>
            <CarbonContentMethod>ASTM D5373-08</CarbonContentMethod>
            <MolecularWeight>
                <IsSubstitutedIndicator>N</IsSubstitutedIndicator>
            </MolecularWeight>
        </OtherProductFeedStockDetails>
    </MonthlyDetails>
    <MonthlyDetails>
        <MonthName>March</MonthName>
        <OtherProductFeedStockDetails>
            <VolumeorMass>
                <IsSubstitutedIndicator>N</IsSubstitutedIndicator>
            </VolumeorMass>
            <VolumeorMassMethod>Tank level measurements</VolumeorMassMethod>
            <CarbonContent>
                <IsSubstitutedIndicator>N</IsSubstitutedIndicator>
            </CarbonContent>
            <CarbonContentMethod>ASTM D5373-08</CarbonContentMethod>
            <MolecularWeight>
                <IsSubstitutedIndicator>N</IsSubstitutedIndicator>
            </MolecularWeight>
        </OtherProductFeedStockDetails>
    </MonthlyDetails>
    <MonthlyDetails>
        <MonthName>April</MonthName>
        <OtherProductFeedStockDetails>
            <VolumeorMass>

```



```
        <IsSubstitutedIndicator>N</IsSubstitutedIndicator>
      </VolumeorMass>
      <VolumeorMassMethod>Tank level measurements</VolumeorMassMethod>
      <CarbonContent>
        <IsSubstitutedIndicator>N</IsSubstitutedIndicator>
      </CarbonContent>
      <CarbonContentMethod>ASTM D5373-08</CarbonContentMethod>
      <MolecularWeight>
        <IsSubstitutedIndicator>N</IsSubstitutedIndicator>
      </MolecularWeight>
    </OtherProductFeedStockDetails>
  </MonthlyDetails>
<MonthlyDetails>
  <MonthName>May</MonthName>
  <OtherProductFeedStockDetails>
    <VolumeorMass>
      <IsSubstitutedIndicator>N</IsSubstitutedIndicator>
    </VolumeorMass>
    <VolumeorMassMethod>Tank level measurements</VolumeorMassMethod>
    <CarbonContent>
      <IsSubstitutedIndicator>N</IsSubstitutedIndicator>
    </CarbonContent>
    <CarbonContentMethod>ASTM D5373-08</CarbonContentMethod>
    <MolecularWeight>
      <IsSubstitutedIndicator>N</IsSubstitutedIndicator>
    </MolecularWeight>
  </OtherProductFeedStockDetails>
</MonthlyDetails>
<MonthlyDetails>
  <MonthName>June</MonthName>
  <OtherProductFeedStockDetails>
    <VolumeorMass>
      <IsSubstitutedIndicator>N</IsSubstitutedIndicator>
    </VolumeorMass>
    <VolumeorMassMethod>Tank level measurements</VolumeorMassMethod>
    <CarbonContent>
      <IsSubstitutedIndicator>N</IsSubstitutedIndicator>
    </CarbonContent>
  </OtherProductFeedStockDetails>
</MonthlyDetails>
```

```
        <CarbonContentMethod>ASTM D5373-08</CarbonContentMethod>
        <MolecularWeight>
            <IsSubstitutedIndicator>N</IsSubstitutedIndicator>
        </MolecularWeight>
    </OtherProductFeedStockDetails>
</MonthlyDetails>
<MonthlyDetails>
    <MonthName>July</MonthName>
    <OtherProductFeedStockDetails>
        <VolumeorMass>
            <IsSubstitutedIndicator>N</IsSubstitutedIndicator>
        </VolumeorMass>
        <VolumeorMassMethod>Tank level measurements</VolumeorMassMethod>
        <CarbonContent>
            <IsSubstitutedIndicator>N</IsSubstitutedIndicator>
        </CarbonContent>
        <CarbonContentMethod>ASTM D5373-08</CarbonContentMethod>
        <MolecularWeight>
            <IsSubstitutedIndicator>N</IsSubstitutedIndicator>
        </MolecularWeight>
    </OtherProductFeedStockDetails>
</MonthlyDetails>
<MonthlyDetails>
    <MonthName>August</MonthName>
    <OtherProductFeedStockDetails>
        <VolumeorMass>
            <IsSubstitutedIndicator>N</IsSubstitutedIndicator>
        </VolumeorMass>
        <VolumeorMassMethod>Tank level measurements</VolumeorMassMethod>
        <CarbonContent>
            <IsSubstitutedIndicator>N</IsSubstitutedIndicator>
        </CarbonContent>
        <CarbonContentMethod>ASTM D5373-08</CarbonContentMethod>
        <MolecularWeight>
            <IsSubstitutedIndicator>N</IsSubstitutedIndicator>
        </MolecularWeight>
    </OtherProductFeedStockDetails>
</MonthlyDetails>
```

```
<MonthlyDetails>
  <MonthName>September</MonthName>
  <OtherProductFeedStockDetails>
    <VolumeorMass>
      <IsSubstitutedIndicator>N</IsSubstitutedIndicator>
    </VolumeorMass>
    <VolumeorMassMethod>Tank level measurements</VolumeorMassMethod>
    <CarbonContent>
      <IsSubstitutedIndicator>N</IsSubstitutedIndicator>
    </CarbonContent>
    <CarbonContentMethod>ASTM D5373-08</CarbonContentMethod>
    <MolecularWeight>
      <IsSubstitutedIndicator>N</IsSubstitutedIndicator>
    </MolecularWeight>
  </OtherProductFeedStockDetails>
</MonthlyDetails>
<MonthlyDetails>
  <MonthName>October</MonthName>
  <OtherProductFeedStockDetails>
    <VolumeorMass>
      <IsSubstitutedIndicator>N</IsSubstitutedIndicator>
    </VolumeorMass>
    <VolumeorMassMethod>Tank level measurements</VolumeorMassMethod>
    <CarbonContent>
      <IsSubstitutedIndicator>N</IsSubstitutedIndicator>
    </CarbonContent>
    <CarbonContentMethod>ASTM D5373-08</CarbonContentMethod>
    <MolecularWeight>
      <IsSubstitutedIndicator>N</IsSubstitutedIndicator>
    </MolecularWeight>
  </OtherProductFeedStockDetails>
</MonthlyDetails>
<MonthlyDetails>
  <MonthName>November</MonthName>
  <OtherProductFeedStockDetails>
    <VolumeorMass>
      <IsSubstitutedIndicator>N</IsSubstitutedIndicator>
    </VolumeorMass>
```

```

        <VolumeorMassMethod>Tank level measurements</VolumeorMassMethod>
        <CarbonContent>
            <IsSubstitutedIndicator>N</IsSubstitutedIndicator>
        </CarbonContent>
        <CarbonContentMethod>ASTM D5373-08</CarbonContentMethod>
        <MolecularWeight>
            <IsSubstitutedIndicator>N</IsSubstitutedIndicator>
        </MolecularWeight>
    </OtherProductFeedStockDetails>
</MonthlyDetails>
<MonthlyDetails>
    <MonthName>December</MonthName>
    <OtherProductFeedStockDetails>
        <VolumeorMass>
            <IsSubstitutedIndicator>N</IsSubstitutedIndicator>
        </VolumeorMass>
        <VolumeorMassMethod>Tank level measurements</VolumeorMassMethod>
        <CarbonContent>
            <IsSubstitutedIndicator>N</IsSubstitutedIndicator>
        </CarbonContent>
        <CarbonContentMethod>ASTM D5373-08</CarbonContentMethod>
        <MolecularWeight>
            <IsSubstitutedIndicator>N</IsSubstitutedIndicator>
        </MolecularWeight>
    </OtherProductFeedStockDetails>
</MonthlyDetails>
</ProductFeedStockDetails>
<XProductDetails>
    <PetroChemicalProductType>Ethylene dichloride</PetroChemicalProductType>
    <EthyleneDichlorideProduced>Integrated EDC/VCM

    <ProductIntermediateQuantity massUOM="Metric Tons">
        <MeasureValue>25</MeasureValue>
    </ProductIntermediateQuantity>
</XProductDetails>
<AdditionalDetails>
    <CarbonContentofWastewater fractionUOM="decimal fraction">
        <MeasureValue>0.32</MeasureValue>
    </CarbonContentofWastewater>
</AdditionalDetails>
Process</EthyleneDichlorideProduced>

```

```

    </CarbonContentofWastewater>
    <AnnualAverageWastewaterFlow UnitsofMeasure="kg">
      <MeasureValue>25</MeasureValue>
    </AnnualAverageWastewaterFlow>
    <CarbonMassofFugitiveEmissions massUOM="Metric Tons">
      <MeasureValue>10</MeasureValue>
    </CarbonMassofFugitiveEmissions>
    <CarbonMassofProcessVents massUOM="Metric Tons">
      <MeasureValue>11</MeasureValue>
    </CarbonMassofProcessVents>
  </AdditionalDetails>
  <AnnualAverageXivtDetails>
    <ProductOrFeedstockIndicator>Feedstock</ProductOrFeedstockIndicator>
    <UnqiueIdentifiser>1</UnqiueIdentifiser>
    <Name>Ethylene dichloride</Name>
    <PhysicalState>Solid</PhysicalState>
    <AverageCarbonContentValue carboncontentUOM="kgC/kg">
      <CalculatedValue>0.220</CalculatedValue>
      <OverrideIndicator>N</OverrideIndicator>
    </AverageCarbonContentValue>
  </AnnualAverageXivtDetails>
  <AnnualAverageXivtDetails>
    <ProductOrFeedstockIndicator>Product</ProductOrFeedstockIndicator>
    <UnqiueIdentifiser>1</UnqiueIdentifiser>
    <Name>Ethylene dichloride</Name>
    <PhysicalState>Liquid</PhysicalState>
    <AverageCarbonContentValue carboncontentUOM="kgC/kg">
      <CalculatedValue>0.001</CalculatedValue>
      <OverrideIndicator>N</OverrideIndicator>
    </AverageCarbonContentValue>
  </AnnualAverageXivtDetails>
</MassBalanceDetails>
<MassBalanceDetails>
  <UnitIdentification>
    <UnitName>Mass3, carbon Black</UnitName>
    <UnitType>Petrochemical process unit</UnitType>
  </UnitIdentification>
  <AnnualCO2Emissions massUOM="Metric Tons">

```

```

        <CalculatedValue>0.0</CalculatedValue>
    </AnnualCO2Emissions>
    <CombustionUnitIdentifiers>none</CombustionUnitIdentifiers>
    <ProductFeedStockDetails>
        <ProductOrFeedstockIndicator>Feedstock</ProductOrFeedstockIndicator>
        <Name>1</Name>
        <Type>Gas oil</Type>
        <AnnualQuantity massUOM="Metric Tons">
            <MeasureValue>50</MeasureValue>
        </AnnualQuantity>
        <PhysicalState>Liquid</PhysicalState>
        <FlowMeterDetails>
            <FlowOrMassDeterminationMethod>none</FlowOrMassDeterminationMethod>
        </FlowMeterDetails>
        <ProcessChangeDates>none</ProcessChangeDates>
        <MonthlyDetails>
            <MonthName>January</MonthName>
            <OtherProductFeedStockDetails>
                <VolumeorMass>
                    <IsSubstitutedIndicator>N</IsSubstitutedIndicator>
                </VolumeorMass>
                <VolumeorMassMethod>Flow meter</VolumeorMassMethod>
                <CarbonContent>
                    <IsSubstitutedIndicator>N</IsSubstitutedIndicator>
                </CarbonContent>
                <CarbonContentMethod>ASTM D1945-03</CarbonContentMethod>
                <MolecularWeight>
                    <IsSubstitutedIndicator>N</IsSubstitutedIndicator>
                </MolecularWeight>
            </OtherProductFeedStockDetails>
        </MonthlyDetails>
        <MonthlyDetails>
            <MonthName>February</MonthName>
            <OtherProductFeedStockDetails>
                <VolumeorMass>
                    <IsSubstitutedIndicator>N</IsSubstitutedIndicator>
                </VolumeorMass>
                <VolumeorMassMethod>Flow meter</VolumeorMassMethod>
            </OtherProductFeedStockDetails>
        </MonthlyDetails>
    </ProductFeedStockDetails>

```

```
        <CarbonContent>
          <IsSubstitutedIndicator>N</IsSubstitutedIndicator>
        </CarbonContent>
        <CarbonContentMethod>ASTM D1945-03</CarbonContentMethod>
        <MolecularWeight>
          <IsSubstitutedIndicator>N</IsSubstitutedIndicator>
        </MolecularWeight>
      </OtherProductFeedStockDetails>
    </MonthlyDetails>
    <MonthlyDetails>
      <MonthName>March</MonthName>
      <OtherProductFeedStockDetails>
        <VolumeorMass>
          <IsSubstitutedIndicator>N</IsSubstitutedIndicator>
        </VolumeorMass>
        <VolumeorMassMethod>Flow meter</VolumeorMassMethod>
        <CarbonContent>
          <IsSubstitutedIndicator>N</IsSubstitutedIndicator>
        </CarbonContent>
        <CarbonContentMethod>ASTM D1945-03</CarbonContentMethod>
        <MolecularWeight>
          <IsSubstitutedIndicator>N</IsSubstitutedIndicator>
        </MolecularWeight>
      </OtherProductFeedStockDetails>
    </MonthlyDetails>
    <MonthlyDetails>
      <MonthName>April</MonthName>
      <OtherProductFeedStockDetails>
        <VolumeorMass>
          <IsSubstitutedIndicator>N</IsSubstitutedIndicator>
        </VolumeorMass>
        <VolumeorMassMethod>Flow meter</VolumeorMassMethod>
        <CarbonContent>
          <IsSubstitutedIndicator>N</IsSubstitutedIndicator>
        </CarbonContent>
        <CarbonContentMethod>ASTM D1945-03</CarbonContentMethod>
        <MolecularWeight>
          <IsSubstitutedIndicator>N</IsSubstitutedIndicator>
        </MolecularWeight>
      </OtherProductFeedStockDetails>
    </MonthlyDetails>
  </MonthlyDetails>
</MonthlyDetails>
```

```
        </MolecularWeight>
      </OtherProductFeedStockDetails>
    </MonthlyDetails>
  <MonthlyDetails>
    <MonthName>May</MonthName>
    <OtherProductFeedStockDetails>
      <VolumeorMass>
        <IsSubstitutedIndicator>N</IsSubstitutedIndicator>
      </VolumeorMass>
      <VolumeorMassMethod>Flow meter</VolumeorMassMethod>
      <CarbonContent>
        <IsSubstitutedIndicator>N</IsSubstitutedIndicator>
      </CarbonContent>
      <CarbonContentMethod>ASTM D1945-03</CarbonContentMethod>
      <MolecularWeight>
        <IsSubstitutedIndicator>N</IsSubstitutedIndicator>
      </MolecularWeight>
    </OtherProductFeedStockDetails>
  </MonthlyDetails>
  <MonthlyDetails>
    <MonthName>June</MonthName>
    <OtherProductFeedStockDetails>
      <VolumeorMass>
        <IsSubstitutedIndicator>N</IsSubstitutedIndicator>
      </VolumeorMass>
      <VolumeorMassMethod>Flow meter</VolumeorMassMethod>
      <CarbonContent>
        <IsSubstitutedIndicator>N</IsSubstitutedIndicator>
      </CarbonContent>
      <CarbonContentMethod>ASTM D1945-03</CarbonContentMethod>
      <MolecularWeight>
        <IsSubstitutedIndicator>N</IsSubstitutedIndicator>
      </MolecularWeight>
    </OtherProductFeedStockDetails>
  </MonthlyDetails>
  <MonthlyDetails>
    <MonthName>July</MonthName>
    <OtherProductFeedStockDetails>
```



```
<VolumeorMass>
  <IsSubstitutedIndicator>N</IsSubstitutedIndicator>
</VolumeorMass>
<VolumeorMassMethod>Flow meter</VolumeorMassMethod>
<CarbonContent>
  <IsSubstitutedIndicator>N</IsSubstitutedIndicator>
</CarbonContent>
<CarbonContentMethod>ASTM D1945-03</CarbonContentMethod>
<MolecularWeight>
  <IsSubstitutedIndicator>N</IsSubstitutedIndicator>
</MolecularWeight>
</OtherProductFeedStockDetails>
</MonthlyDetails>
<MonthlyDetails>
  <MonthName>August</MonthName>
  <OtherProductFeedStockDetails>
    <VolumeorMass>
      <IsSubstitutedIndicator>N</IsSubstitutedIndicator>
    </VolumeorMass>
    <VolumeorMassMethod>Flow meter</VolumeorMassMethod>
    <CarbonContent>
      <IsSubstitutedIndicator>N</IsSubstitutedIndicator>
    </CarbonContent>
    <CarbonContentMethod>ASTM D1945-03</CarbonContentMethod>
    <MolecularWeight>
      <IsSubstitutedIndicator>N</IsSubstitutedIndicator>
    </MolecularWeight>
  </OtherProductFeedStockDetails>
</MonthlyDetails>
<MonthlyDetails>
  <MonthName>September</MonthName>
  <OtherProductFeedStockDetails>
    <VolumeorMass>
      <IsSubstitutedIndicator>N</IsSubstitutedIndicator>
    </VolumeorMass>
    <VolumeorMassMethod>Flow meter</VolumeorMassMethod>
    <CarbonContent>
      <IsSubstitutedIndicator>N</IsSubstitutedIndicator>
    </CarbonContent>
```

```
        </CarbonContent>
        <CarbonContentMethod>ASTM D1945-03</CarbonContentMethod>
        <MolecularWeight>
            <IsSubstitutedIndicator>N</IsSubstitutedIndicator>
        </MolecularWeight>
    </OtherProductFeedStockDetails>
</MonthlyDetails>
<MonthlyDetails>
    <MonthName>October</MonthName>
    <OtherProductFeedStockDetails>
        <VolumeorMass>
            <IsSubstitutedIndicator>N</IsSubstitutedIndicator>
        </VolumeorMass>
        <VolumeorMassMethod>Flow meter</VolumeorMassMethod>
        <CarbonContent>
            <IsSubstitutedIndicator>N</IsSubstitutedIndicator>
        </CarbonContent>
        <CarbonContentMethod>ASTM D1945-03</CarbonContentMethod>
        <MolecularWeight>
            <IsSubstitutedIndicator>N</IsSubstitutedIndicator>
        </MolecularWeight>
    </OtherProductFeedStockDetails>
</MonthlyDetails>
<MonthlyDetails>
    <MonthName>November</MonthName>
    <OtherProductFeedStockDetails>
        <VolumeorMass>
            <IsSubstitutedIndicator>N</IsSubstitutedIndicator>
        </VolumeorMass>
        <VolumeorMassMethod>Flow meter</VolumeorMassMethod>
        <CarbonContent>
            <IsSubstitutedIndicator>N</IsSubstitutedIndicator>
        </CarbonContent>
        <CarbonContentMethod>ASTM D1945-03</CarbonContentMethod>
        <MolecularWeight>
            <IsSubstitutedIndicator>N</IsSubstitutedIndicator>
        </MolecularWeight>
    </OtherProductFeedStockDetails>
```

```
</MonthlyDetails>
<MonthlyDetails>
  <MonthName>December</MonthName>
  <OtherProductFeedStockDetails>
    <VolumeorMass>
      <IsSubstitutedIndicator>N</IsSubstitutedIndicator>
    </VolumeorMass>
    <VolumeorMassMethod>Flow meter</VolumeorMassMethod>
    <CarbonContent>
      <IsSubstitutedIndicator>N</IsSubstitutedIndicator>
    </CarbonContent>
    <CarbonContentMethod>ASTM D1945-03</CarbonContentMethod>
    <MolecularWeight>
      <IsSubstitutedIndicator>N</IsSubstitutedIndicator>
    </MolecularWeight>
  </OtherProductFeedStockDetails>
</MonthlyDetails>
</ProductFeedStockDetails>
<ProductFeedStockDetails>
  <ProductOrFeedstockIndicator>Product</ProductOrFeedstockIndicator>
  <Name>1</Name>
  <Type>Carbon Black</Type>
  <AnnualQuantity massUOM="Metric Tons">
    <MeasureValue>70</MeasureValue>
  </AnnualQuantity>
  <PhysicalState>Liquid</PhysicalState>
  <FlowMeterDetails>
    <FlowOrMassDeterminationMethod>0</FlowOrMassDeterminationMethod>
  </FlowMeterDetails>
  <ProcessChangeDates>0</ProcessChangeDates>
  <MonthlyDetails>
    <MonthName>January</MonthName>
    <OtherProductFeedStockDetails>
      <VolumeorMass>
        <IsSubstitutedIndicator>N</IsSubstitutedIndicator>
      </VolumeorMass>
      <VolumeorMassMethod>Flow meter</VolumeorMassMethod>
      <CarbonContent>
```

```
        <IsSubstitutedIndicator>N</IsSubstitutedIndicator>
      </CarbonContent>
      <CarbonContentMethod>SW-846 Method 8031</CarbonContentMethod>
      <MolecularWeight>
        <IsSubstitutedIndicator>N</IsSubstitutedIndicator>
      </MolecularWeight>
    </OtherProductFeedStockDetails>
  </MonthlyDetails>
<MonthlyDetails>
  <MonthName>February</MonthName>
  <OtherProductFeedStockDetails>
    <VolumeorMass>
      <IsSubstitutedIndicator>N</IsSubstitutedIndicator>
    </VolumeorMass>
    <VolumeorMassMethod>Flow meter</VolumeorMassMethod>
    <CarbonContent>
      <IsSubstitutedIndicator>N</IsSubstitutedIndicator>
    </CarbonContent>
    <CarbonContentMethod>SW-846 Method 8031</CarbonContentMethod>
    <MolecularWeight>
      <IsSubstitutedIndicator>N</IsSubstitutedIndicator>
    </MolecularWeight>
  </OtherProductFeedStockDetails>
</MonthlyDetails>
<MonthlyDetails>
  <MonthName>March</MonthName>
  <OtherProductFeedStockDetails>
    <VolumeorMass>
      <IsSubstitutedIndicator>N</IsSubstitutedIndicator>
    </VolumeorMass>
    <VolumeorMassMethod>Flow meter</VolumeorMassMethod>
    <CarbonContent>
      <IsSubstitutedIndicator>N</IsSubstitutedIndicator>
    </CarbonContent>
    <CarbonContentMethod>SW-846 Method 8031</CarbonContentMethod>
    <MolecularWeight>
      <IsSubstitutedIndicator>N</IsSubstitutedIndicator>
    </MolecularWeight>
  </OtherProductFeedStockDetails>
</MonthlyDetails>
```

```
        </OtherProductFeedStockDetails>
    </MonthlyDetails>
    <MonthlyDetails>
        <MonthName>April</MonthName>
        <OtherProductFeedStockDetails>
            <VolumeorMass>
                <IsSubstitutedIndicator>N</IsSubstitutedIndicator>
            </VolumeorMass>
            <VolumeorMassMethod>Flow meter</VolumeorMassMethod>
            <CarbonContent>
                <IsSubstitutedIndicator>N</IsSubstitutedIndicator>
            </CarbonContent>
            <CarbonContentMethod>SW-846 Method 8031</CarbonContentMethod>
            <MolecularWeight>
                <IsSubstitutedIndicator>N</IsSubstitutedIndicator>
            </MolecularWeight>
        </OtherProductFeedStockDetails>
    </MonthlyDetails>
    <MonthlyDetails>
        <MonthName>May</MonthName>
        <OtherProductFeedStockDetails>
            <VolumeorMass>
                <IsSubstitutedIndicator>N</IsSubstitutedIndicator>
            </VolumeorMass>
            <VolumeorMassMethod>Flow meter</VolumeorMassMethod>
            <CarbonContent>
                <IsSubstitutedIndicator>N</IsSubstitutedIndicator>
            </CarbonContent>
            <CarbonContentMethod>SW-846 Method 8031</CarbonContentMethod>
            <MolecularWeight>
                <IsSubstitutedIndicator>N</IsSubstitutedIndicator>
            </MolecularWeight>
        </OtherProductFeedStockDetails>
    </MonthlyDetails>
    <MonthlyDetails>
        <MonthName>June</MonthName>
        <OtherProductFeedStockDetails>
            <VolumeorMass>
```

```

        <IsSubstitutedIndicator>N</IsSubstitutedIndicator>
      </VolumeorMass>
      <VolumeorMassMethod>Flow meter</VolumeorMassMethod>
      <CarbonContent>
        <IsSubstitutedIndicator>N</IsSubstitutedIndicator>
      </CarbonContent>
      <CarbonContentMethod>SW-846 Method 8031</CarbonContentMethod>
      <MolecularWeight>
        <IsSubstitutedIndicator>N</IsSubstitutedIndicator>
      </MolecularWeight>
    </OtherProductFeedStockDetails>
  </MonthlyDetails>
<MonthlyDetails>
  <MonthName>July</MonthName>
  <OtherProductFeedStockDetails>
    <VolumeorMass>
      <IsSubstitutedIndicator>N</IsSubstitutedIndicator>
    </VolumeorMass>
    <VolumeorMassMethod>Flow meter</VolumeorMassMethod>
    <CarbonContent>
      <IsSubstitutedIndicator>N</IsSubstitutedIndicator>
    </CarbonContent>
    <CarbonContentMethod>SW-846 Method 8031</CarbonContentMethod>
    <MolecularWeight>
      <IsSubstitutedIndicator>N</IsSubstitutedIndicator>
    </MolecularWeight>
  </OtherProductFeedStockDetails>
</MonthlyDetails>
<MonthlyDetails>
  <MonthName>August</MonthName>
  <OtherProductFeedStockDetails>
    <VolumeorMass>
      <IsSubstitutedIndicator>N</IsSubstitutedIndicator>
    </VolumeorMass>
    <VolumeorMassMethod>Flow meter</VolumeorMassMethod>
    <CarbonContent>
      <IsSubstitutedIndicator>N</IsSubstitutedIndicator>
    </CarbonContent>
  </OtherProductFeedStockDetails>
</MonthlyDetails>

```

```
        <CarbonContentMethod>SW-846 Method 8031</CarbonContentMethod>
        <MolecularWeight>
            <IsSubstitutedIndicator>N</IsSubstitutedIndicator>
        </MolecularWeight>
    </OtherProductFeedStockDetails>
</MonthlyDetails>
<MonthlyDetails>
    <MonthName>September</MonthName>
    <OtherProductFeedStockDetails>
        <VolumeorMass>
            <IsSubstitutedIndicator>N</IsSubstitutedIndicator>
        </VolumeorMass>
        <VolumeorMassMethod>Flow meter</VolumeorMassMethod>
        <CarbonContent>
            <IsSubstitutedIndicator>N</IsSubstitutedIndicator>
        </CarbonContent>
        <CarbonContentMethod>SW-846 Method 8031</CarbonContentMethod>
        <MolecularWeight>
            <IsSubstitutedIndicator>N</IsSubstitutedIndicator>
        </MolecularWeight>
    </OtherProductFeedStockDetails>
</MonthlyDetails>
<MonthlyDetails>
    <MonthName>October</MonthName>
    <OtherProductFeedStockDetails>
        <VolumeorMass>
            <IsSubstitutedIndicator>N</IsSubstitutedIndicator>
        </VolumeorMass>
        <VolumeorMassMethod>Flow meter</VolumeorMassMethod>
        <CarbonContent>
            <IsSubstitutedIndicator>N</IsSubstitutedIndicator>
        </CarbonContent>
        <CarbonContentMethod>SW-846 Method 8031</CarbonContentMethod>
        <MolecularWeight>
            <IsSubstitutedIndicator>N</IsSubstitutedIndicator>
        </MolecularWeight>
    </OtherProductFeedStockDetails>
</MonthlyDetails>
```

```
<MonthlyDetails>
  <MonthName>November</MonthName>
  <OtherProductFeedStockDetails>
    <VolumeorMass>
      <IsSubstitutedIndicator>N</IsSubstitutedIndicator>
    </VolumeorMass>
    <VolumeorMassMethod>Flow meter</VolumeorMassMethod>
    <CarbonContent>
      <IsSubstitutedIndicator>N</IsSubstitutedIndicator>
    </CarbonContent>
    <CarbonContentMethod>SW-846 Method 8031</CarbonContentMethod>
    <MolecularWeight>
      <IsSubstitutedIndicator>N</IsSubstitutedIndicator>
    </MolecularWeight>
  </OtherProductFeedStockDetails>
</MonthlyDetails>
<MonthlyDetails>
  <MonthName>December</MonthName>
  <OtherProductFeedStockDetails>
    <VolumeorMass>
      <IsSubstitutedIndicator>N</IsSubstitutedIndicator>
    </VolumeorMass>
    <VolumeorMassMethod>Flow meter</VolumeorMassMethod>
    <CarbonContent>
      <IsSubstitutedIndicator>N</IsSubstitutedIndicator>
    </CarbonContent>
    <CarbonContentMethod>SW-846 Method 8031</CarbonContentMethod>
    <MolecularWeight>
      <IsSubstitutedIndicator>N</IsSubstitutedIndicator>
    </MolecularWeight>
  </OtherProductFeedStockDetails>
</MonthlyDetails>
</ProductFeedStockDetails>
<XProductDetails>
  <PetroChemicalProductType>Carbon Black</PetroChemicalProductType>
  <ProductQuantity masUOM="Metric Tons">
    <MeasureValue>100</MeasureValue>
  </ProductQuantity>
</XProductDetails>
```



```
</XProductDetails>
<AdditionalDetails>
  <CarbonContentofWastewater fractionUOM="decimal fraction">
    <MeasureValue>0.33</MeasureValue>
  </CarbonContentofWastewater>
  <AnnualAverageWastewaterFlow UnitsofMeasure="gal">
    <MeasureValue>40</MeasureValue>
  </AnnualAverageWastewaterFlow>
  <CarbonMassofFugitiveEmissions massUOM="Metric Tons">
    <MeasureValue>1</MeasureValue>
  </CarbonMassofFugitiveEmissions>
  <CarbonMassofProcessVents massUOM="Metric Tons">
    <MeasureValue>2</MeasureValue>
  </CarbonMassofProcessVents>
</AdditionalDetails>
<AnnualAverageXIvtDetails>
  <ProductOrFeedstockIndicator>Feedstock</ProductOrFeedstockIndicator>
  <UnqiueIdentifier>1</UnqiueIdentifier>
  <Name>Gas oil</Name>
  <PhysicalState>Liquid</PhysicalState>
  <AverageCarbonContentValue carboncontentUOM="kgC/kg">
    <CalculatedValue>0.170</CalculatedValue>
    <OverrideIndicator>N</OverrideIndicator>
  </AverageCarbonContentValue>
</AnnualAverageXIvtDetails>
<AnnualAverageXIvtDetails>
  <ProductOrFeedstockIndicator>Product</ProductOrFeedstockIndicator>
  <UnqiueIdentifier>1</UnqiueIdentifier>
  <Name>Carbon Black</Name>
  <PhysicalState>Liquid</PhysicalState>
  <AverageCarbonContentValue carboncontentUOM="kgC/kg">
    <CalculatedValue>0.140</CalculatedValue>
    <OverrideIndicator>N</OverrideIndicator>
  </AverageCarbonContentValue>
</AnnualAverageXIvtDetails>
</MassBalanceDetails>
</SubPartX>
</SubPartInformation>
```

```
</FacilitySiteDetails>  
<StartDate>2020-01-01</StartDate>  
<EndDate>2020-12-31</EndDate>  
<DateTimeReportGenerated>2021-02-22T08:35:53</DateTimeReportGenerated>  
<SubpartBAMMDetails>  
  <SubpartName>X</SubpartName>  
</SubpartBAMMDetails>  
</FacilitySiteInformation>  
</GHG>
```